



# **ASI Mini Camera Manual**

Revision 1.3

July, 2018

All materials related to this publication are subject to change without notice and its copyright totally belongs to Suzhou ZWO CO.,LTD.



## Table of Contents

ASI Mini Camera Manual .....	1
1. Instruction .....	3
2. Camera Models and Sensor Type .....	4
3. What's in the box? .....	4
4. Camera technical specifications .....	5
5. QE Graph & Read Noise.....	6
6. Getting to know your camera.....	10
6.1 External View .....	10
6.4 Protect Window .....	10
6.5 Analog to Digital Converter (ADC) .....	10
6.6 Binning.....	11
7. How to use your camera.....	11
8. Cleaning .....	12
9. Mechanical drawing.....	14
10. Servicing .....	14
11. Warranty .....	14



# 1. Instruction

Congratulations and thank you for buying one of our ASI Cameras! This manual will give you a brief introduction to your ASI camera. Please read it thoroughly. If you have any other questions, please feel free to contact us. [info@zwoptical.com](mailto:info@zwoptical.com)

ASI Mini Cameras are designed for both Guiding and Photography.  
Its excellent performance and multifunctional usage will impress you a lot!

For software installation instructions and other technical information please refer to “Support” on our official website.  
<https://astronomy-imaging-camera.com/>

## 2. Camera Models and Sensor Type

There are 2 types of ASI mini models:

Model	Mono or Color	USB Speed	Sensor
ASI120MM Mini	Mono	USB2.0	AR0130
ASI290MM Mini	Mono	USB2.0	IMX290
ASI174MM Mini	Mono	USB2.0	IMX174

## 3. What's in the box?

ASI120MM mini / ASI290MM mini / ASI174MM mini



## 4. Camera technical specifications

	ASI120MM Mini	ASI290MM Mini	ASI174MM Mini
Sensor	1/3" CMOS	1 / 2.8" CMOS	1/1.2" CMOS
Diagonal	6.09mm	6.5mm	13.2MM
Resolution	1.2 Mega Pixels 1280×960	2.1Mega Pixels 1936×1096	2.3Mega Pixels 1936×1216
Pixel Size	3.75μm	2.9μm	5.86μm
Image area	4.8mm*3.6mm	5.6mm*3.2mm	11.3mm*7.1mm
Max FPS at full resolution	35FPS	20.4FPS	18.4FPS
Shutter	Rolling shutter	Rolling shutter	Global shutter
Exposure Range	64μs-2000s	32μs-2000s	32μs-2000s
Read Noise	4.0-6.5e	1.0~3.2e	3.5-6.0e
QE peak	Almost 80%	80%	78%
Full well	13k e	14.6k e	32k e
ADC	12 bit	12 bit/10 bit	12 bit/10 bit
Interface	USB2.0	USB2.0	USB2.0
Adapters	1.25"/M28.5	1.25"/M28.5	1.25"/M28.5
Protect window	AR window	AR window	AR window
Dimensions	φ36mm*61mm	φ36mm*61mm	φ36mm*61mm
Weight	60g	60g	60g
Back Focus Distance	8.5mm	8.5mm	8.5mm
Supported OS	Windows, Linux & Mac OSX	Windows, Linux & Mac O60g SX	Windows, Linux & Mac OSX
Working Temperature	-5°C—45°C	-5°C—45°C	-5°C—45°C
Storage Temperature	-20°C—60°C	-20°C—60°C	-20°C—60°C
Working Relative Humidity	20%—80%	20%—80%	20%—80%
Storage Relative Humidity	20%—95%	20%—95%	20%—95%

## 5. QE Graph & Read Noise

QE and Read Noise are the most important parameters to measure the performance of a camera. Higher QE and lower Read Noise are needed to improve the SNR of an image.

Mono 120 sensor Relative QE Curve

**AR0130CS**

### SPECTRAL CHARACTERISTICS

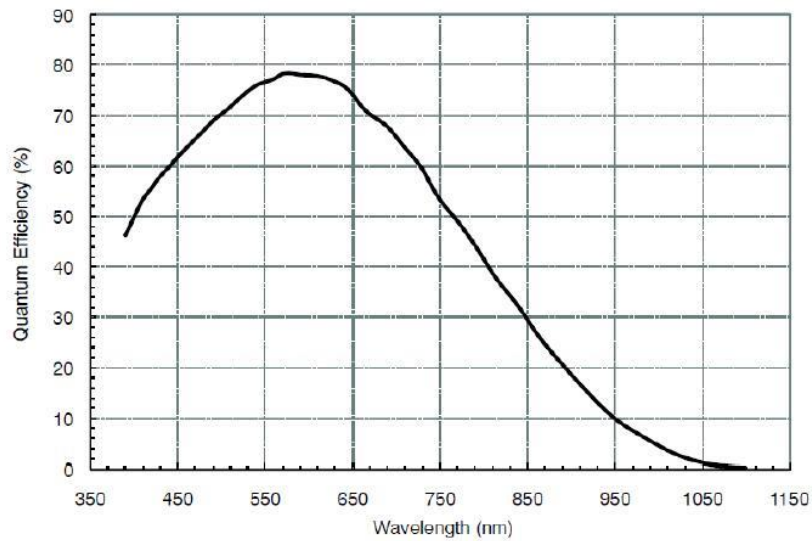
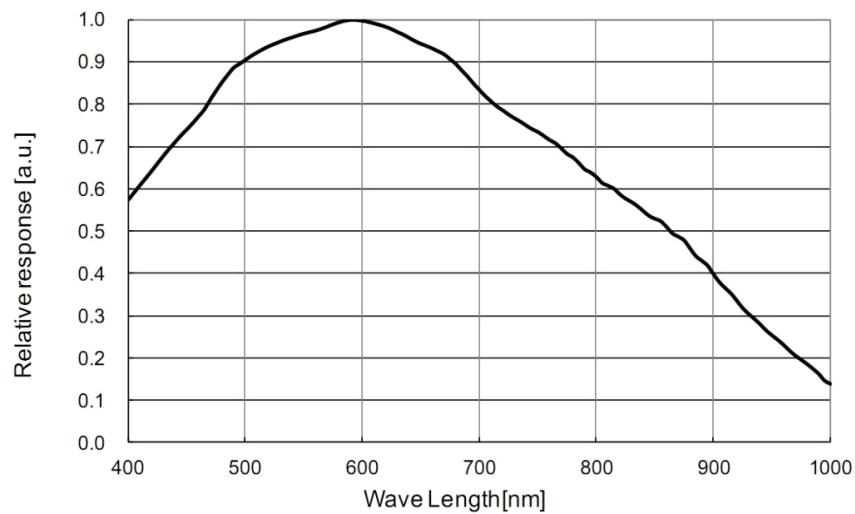
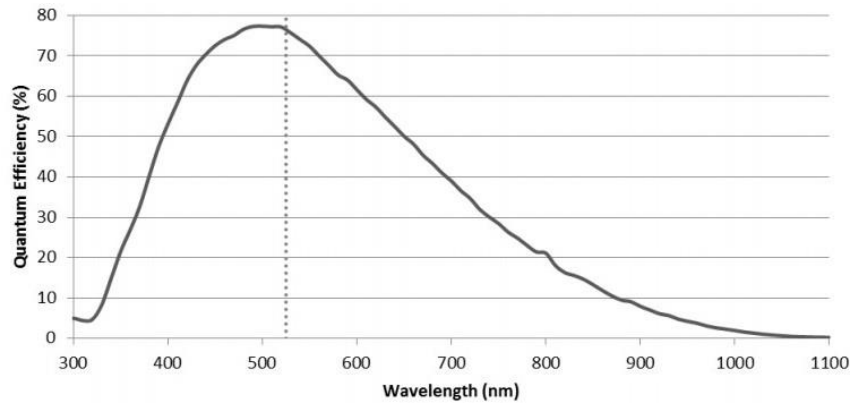

Figure 26. Quantum Efficiency - Monochrome Sensor

Mono 290 sensor Relative QE Curve



Mono174 sensor Relative QE Curve



Read Noise includes pixel diode noise, circuit noise and ADC quantization error noise, and the lower the better.

The Read Noise of the mini cameras is extremely lower when compared with traditional CCD cameras. It is even lower when the camera is set at a higher Gain.

Depending on your target, you can set the Gain lower for higher Dynamic Range (longer exposure) or set the Gain higher for lower noise (such as short exposure or lucky imaging).

Read noise, full well, gain and dynamic range for ASI120

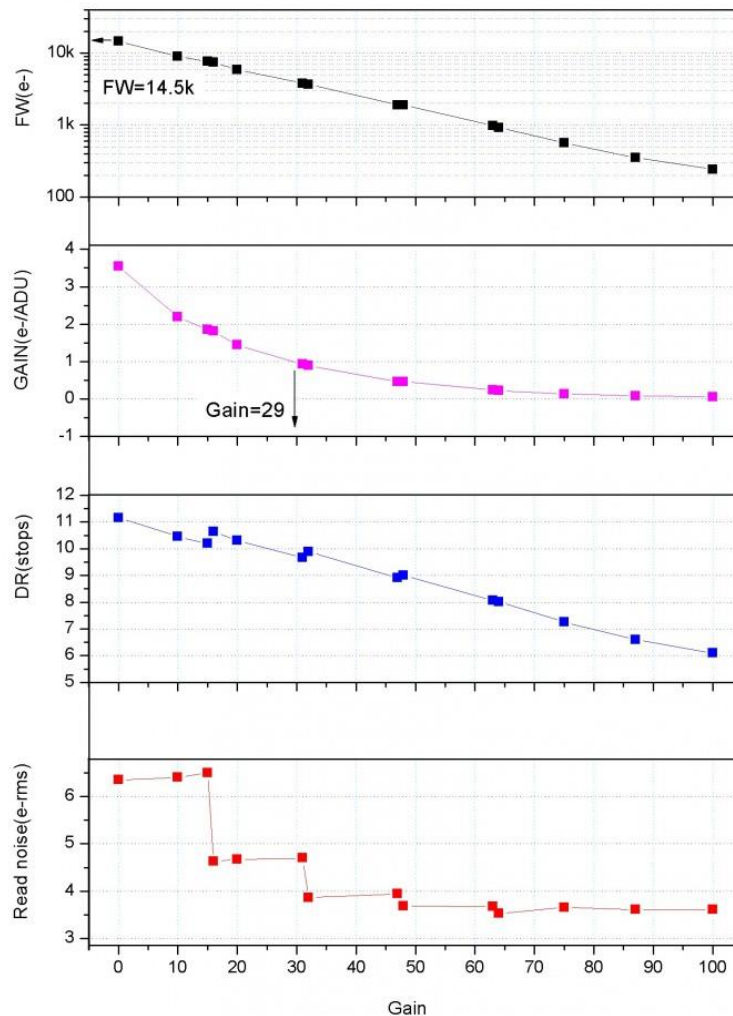

Read noise, full well, gain and dynamic range for ASI290

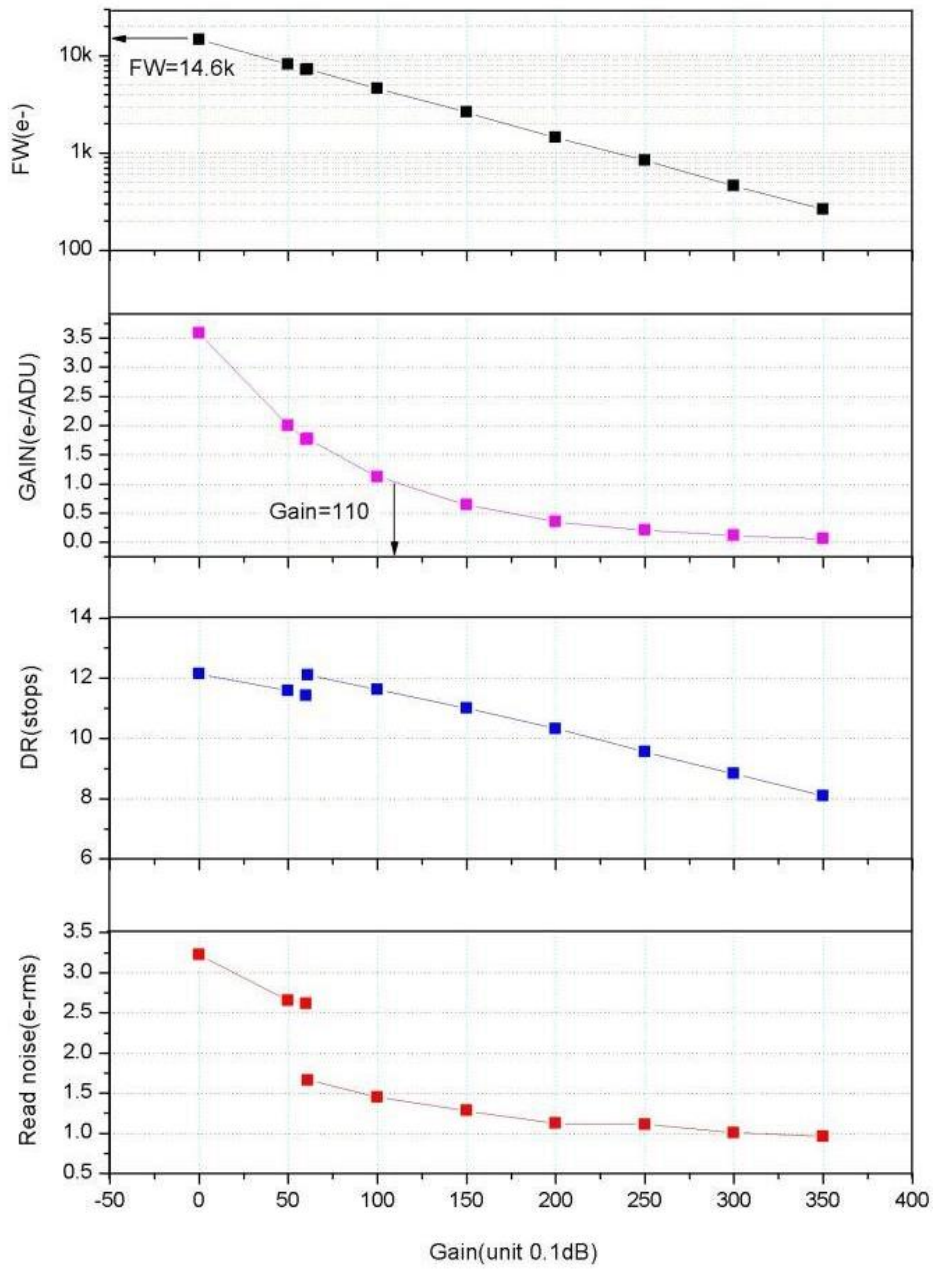



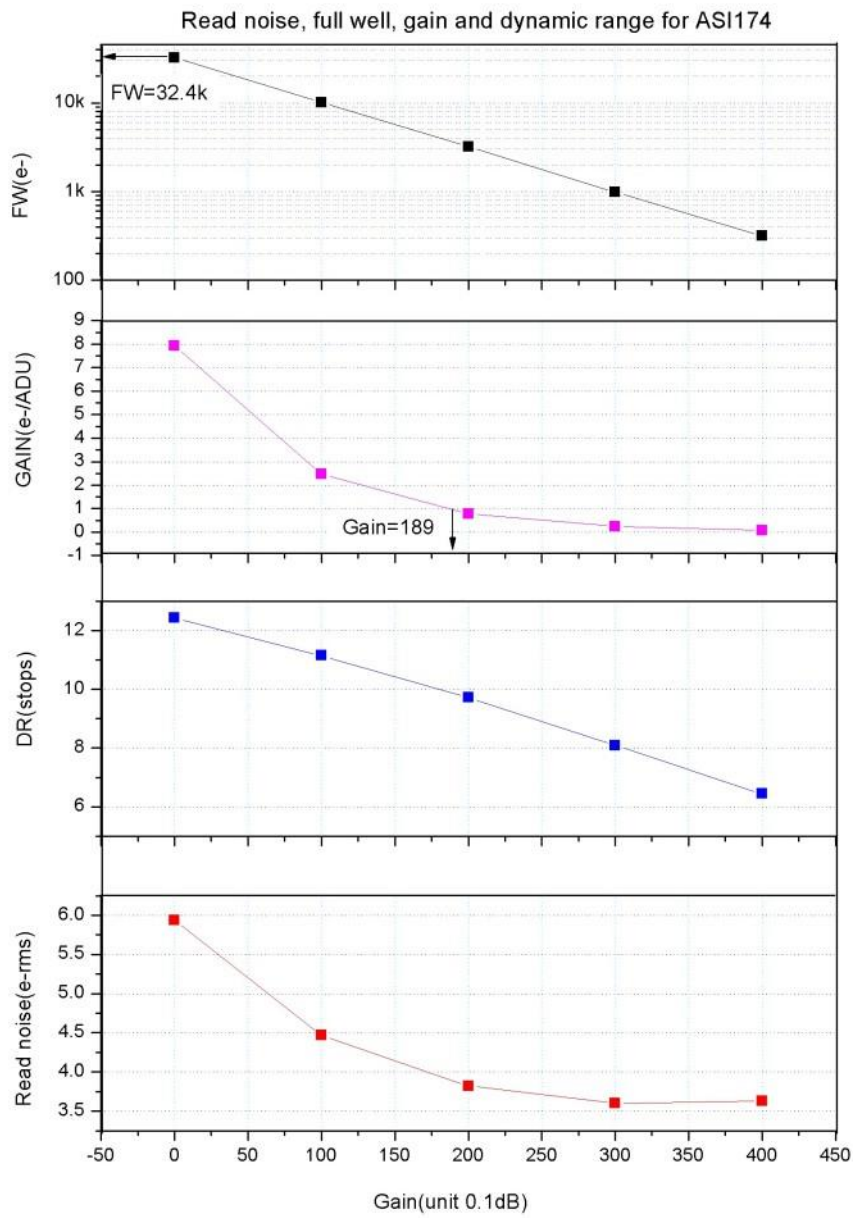

## 6. Getting to know your camera

### 6.1 External View



### 6.4 Protect Window

ASI Mini camera comes with the AR window, thickness is 1.1 mm.

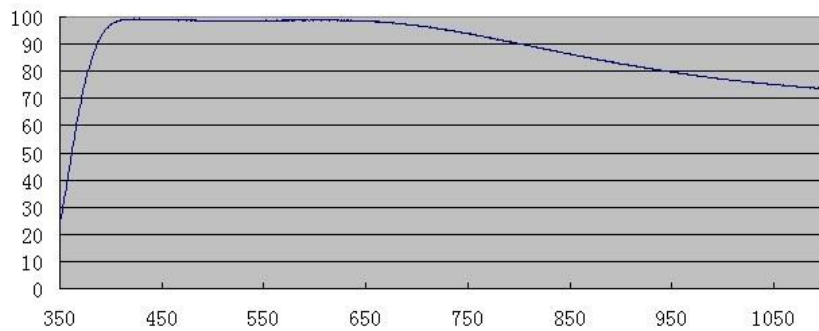

### 6.5 Analog to Digital Converter (ADC)

ASI Mini camera records in 12bit ADC, 290 and 174 mini support 10bit ADC. This camera also supports ROI (region of interest) shooting, and this smaller ROI has faster fps.

## 6.6 Binning

ASI Mini camera supports software bin2 mode. We recommend customer to use software binning if you don't care speed.

## 7. How to use your camera

There are many adapters available for this camera for connecting to your scope or lens. Some are included with the camera and others you can order from our site:

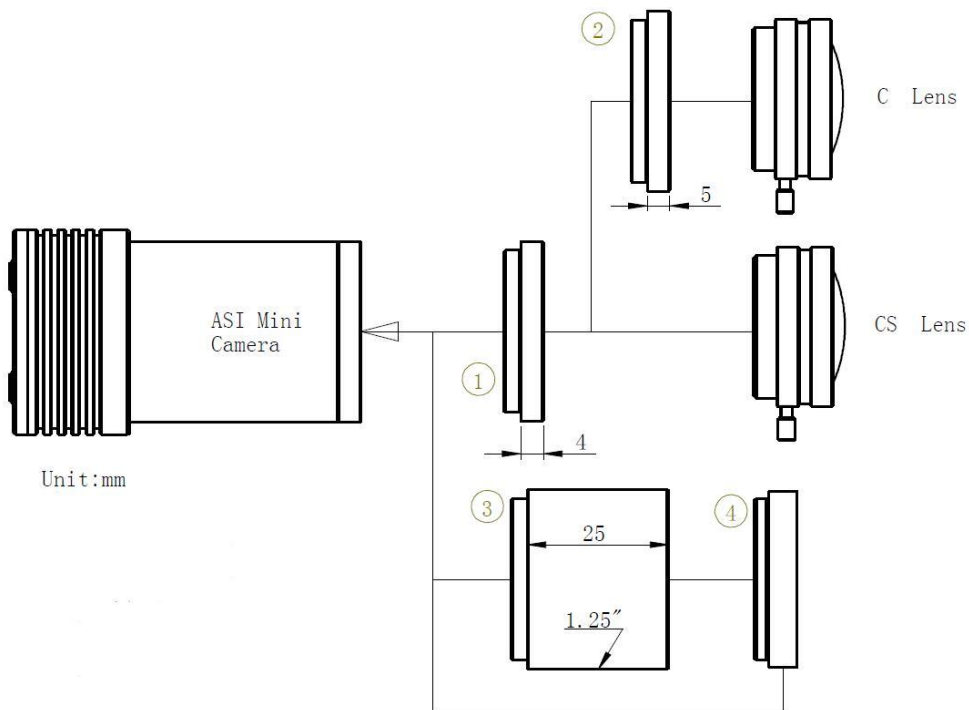

1. CS adapter
2. C/CS Adapter
3. 1.25" extender
4. 1.25" filter(optional)

ASI Mini Cameras  
External Device Connecting Drawing

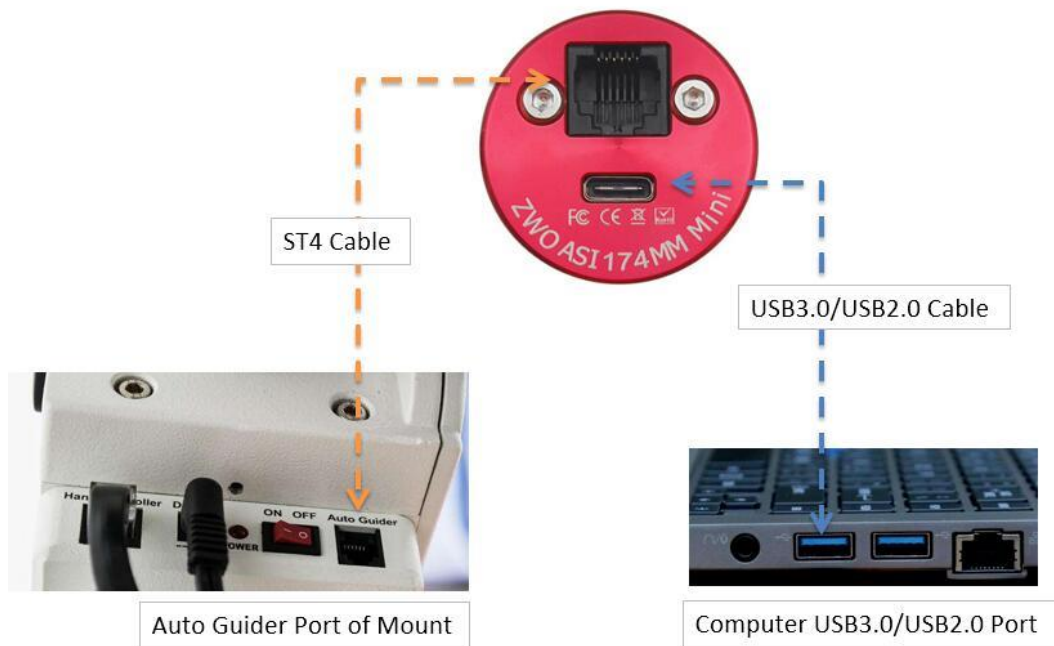

## 8. Cleaning

The camera comes with an AR protect window, which can protect the sensor from dust and humidity. Should you need to clean the sensor, it's better to do so during the daytime. To see the dust, you just need to setup your telescope and point it to a bright place. A Barlow is required to see these dusts clear. Then attach the camera and adjust the exposure to make sure not over exposed. You can see an image like below if it's dirty.

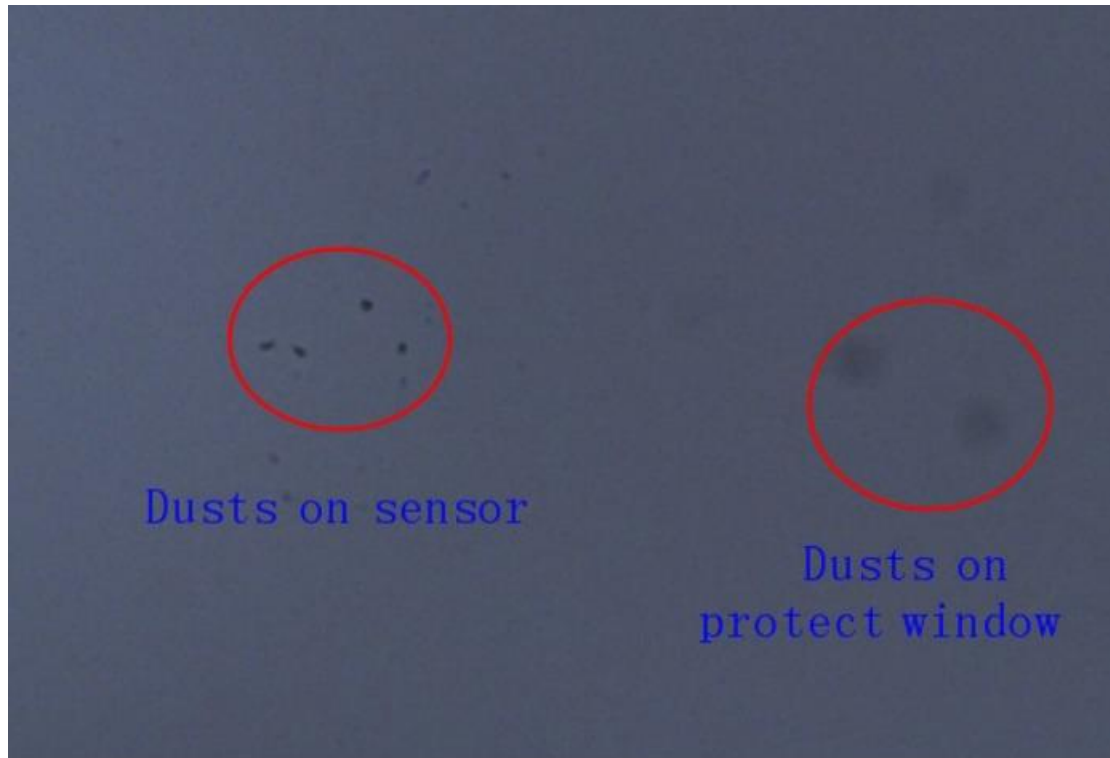

The big dim spot on the image (at right ) are the shadows of dust on the protect window.

The very small but very dark spot in the image (at left) are the shadows of the dusts on the sensor.

The suggested way to clean them is try to blow them away with a manual air pump. To clean the dust on the sensor you will need to open the camera chamber.

We have a very detailed instruction on our website:

<https://astronomy-imaging-camera.com/manuals/>

### Quickguide

- [ZWO ASI Camera Quick Guide](#)
- [ZWO ASI Cooled Camera Quick Guide](#)
- [How to clean ASI camera and redry the desiccant](#)

## 9. Mechanical drawing

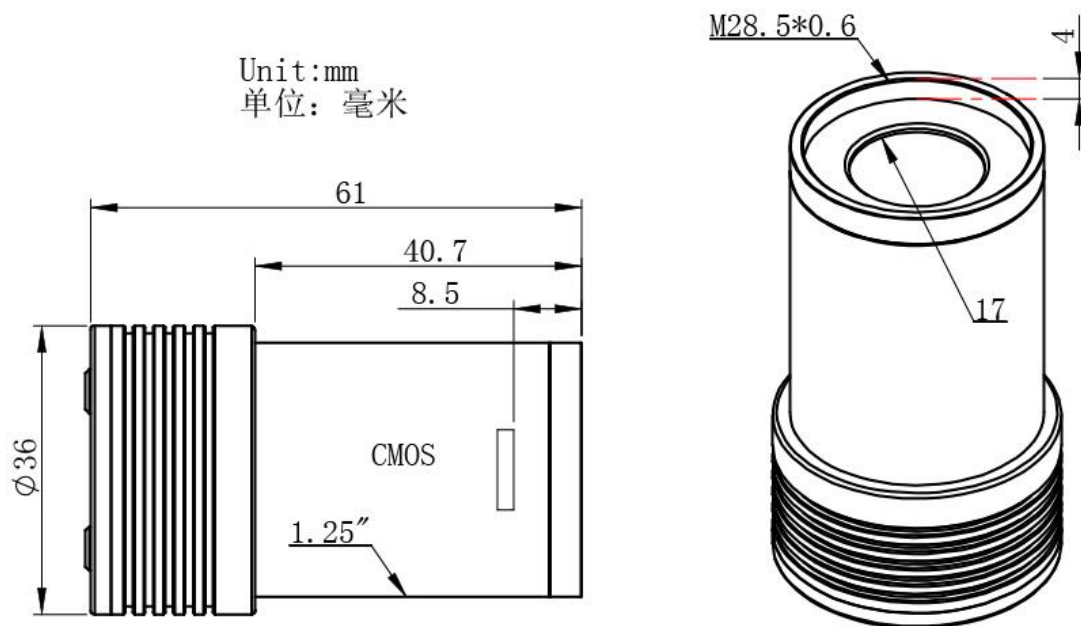

## 10. Servicing

For software upgrades please refer to “Support-manual and software” on our official website.

<https://astronomy-imaging-camera.com/>

Repairs and servicing are available by emailing [info@zwoptical.com](mailto:info@zwoptical.com)

For customers who bought the camera from your local dealer, dealer is responsible for the customer service.

## 11. Warranty

We provide 2-year warranty for our products. We offer repair service or replacement for free if the camera doesn't work within warranty period.

After the warranty period, we continue to provide repair support and service on a charged basis.

This warranty does not apply to damage that occurred as a result of abuse or misuse, or caused by a fall or any other transportation failures after purchase.

Customer must pay for shipping when shipping the camera back for repair or replacement.