



iOptron® HAE69B iMate Strain Wave GoTo AZ/EQ Mount

Instruction Manual

Product HAE69B and HAE69B EC iMate



Read the Quick Setup Guide (QSG) BEFORE setting up and operating the mount! Read the full online Instruction Manual for details.

If you have any questions please contact us at support@ioptron.com



WARNING!

***NEVER USE A TELESCOPE TO LOOK AT THE SUN WITHOUT A PROPER FILTER!
Looking at or near the Sun will cause instant and irreversible damage to your eye.
Children should always have adult supervision while observing.***

Table of Content

Table of Content	3
1. HAE69B iMate Overview	5
2. HAE69B Terms	7
2.1. Parts List	7
2.2. Identification of Parts	8
2.3. HAE69B Mount Ports	8
2.4. HAE69B Mount Control	10
3. HAE69B Mount Assembly	11
4. HAE69B Mount Operation via the iMate and KStars/Ekos	17
4.1. Initial Set Up iMate for HAE69B	17
4.2. Operation HAE69B via an iMate and KStars/Ekos	24
4.2.1. Set up iMate Time	24
4.2.2. Set up iMate Site Info (GPS location)	25
4.2.3. Set up Zero Position	26
4.2.4. Add Other Devices	27
4.2.5. Polar Alignment	27
4.3. Other iMate Functions	27
4.3.1. iMate DC Power Output Control	27
4.3.2. iPolarServer	28
5. HAE69B Mount Operation via an 8411 Handset	29
5.1. Go2Nova [®] 8411 Handset	29
5.1.1. Key Description	29
5.1.2. The Display	30
5.2. Install and Check the Handset Battery	31
5.3. Connect DC power and handset	31
5.4. Setup Handset	32
5.5. Zero Position	33
5.6. Perform Polar Alignment (EQ mode)	34
5.7. Go To a Celestial Object	34
5.8. Complete Function of a Go2Nova [®] 8411 Handset	35
5.8.1. Slew to an Object	35
5.8.2. Sync to Target	36
5.8.3. Alignment	36
5.8.4. Settings	36
5.8.5. Edit User Objects	39
5.8.6. Firmware Information	40
5.8.7. Zero Position	40
6. HAE69B Mount Operation via iOptron Commander	41
6.1. Download and Install ASCOM Platform and Commander	41
6.2. Connect HAE69B to a Computer	42
6.3. Use iOptron Commander	42
6.3.1. Connect the mount via Commander	42
6.3.2. Set up Time and Site	43
6.3.3. Set Zero Position	44
6.3.4. Move the Mount Manually	45
6.3.5. GoTo an Object	45
6.3.6. Other Settings	46
7. Maintenance and Servicing	47

7.1. Maintenance	47
7.2. iOptron Customer Service	47
7.3. Product End of Life Disposal Instructions	47
7.4. Battery Replacement and Disposal Instructions	47
Appendix A. Technical Specifications	48
Appendix B. Go2Nova [®] 8411 HANDSET MENU STRUCTURE	49
Appendix C. Go2Nova [®] Star List	52
Appendix D. Firmware Upgrade	61
Appendix E. Computer Control an HAE Mount	62
IOPTRON TWO YEAR TELESCOPE, MOUNT, AND CONTROLLER WARRANTY.....	63

1. HAE69B iMate Overview

Keeping pace with the current rapidly developing technology environment the iOptron HAE69 and HAE69EC SWG mounts have evolved into the HAE69B iMate™.

These light weight, compact, medium payload titans will deliver an astronomy experience like never before. Applying iOptron's multi-decade experience creating precision mounts, the HAE brings this vision to reality.

Utilizing state of the art strain wave gear technology for both RA and DEC movement, the HAEs deliver unparalleled weight to payload efficiency. Its black anodized all metal CNC machined body is not only appealing to the eye, it's a rugged platform that will perform at the highest level for many years to come. Unique features such as an electronic friction brake and power down memory allow the mount to safely stop and resume a GoTo slew or continue tracking even after an abrupt power loss (No need to realign and start from the beginning).

The "iMate" models feature a powerful 64-bit ARM based on-board computer with Wi-Fi, preloaded KStars planetarium software, Ekos control and automation tool and INDI drivers. This hardware-software combination will support the use of most current and future devices (cameras, focusers, filter wheels, etc.) allowing the user choice of brand and model.

With 32Gb eMMC storage along with a slot for an up to 64Gb TF (micro SD) memory, iMate has the ability to control and capture an entire automated imaging session. The iMate is cross-platform; use it with Windows, IOS, Linux, Android, etc.

HAE69B iMate dual SWG AZ/EQ mounts have an internal main board and no longer requires using with a handset. All the accessories can be connected to the iMate and there is no cable drags when the mount is operating.

An HAE69B mount can be controlled by the on-board computer iMate; a computer via USB-C port on the mount base with ASCOM/Commander for a Windows PC or a third party INDI driver for MacOS/Linux (Pi) computer; or an Go2Nova 8411 handset.

The HAE69B EC features a high precision encoder on RA axis that delivers incredible tracking accuracy, enough that many will choose to image "sans" guiding.

Features:

- Advanced Strain Wave Gear (SWG) technology
- Payload capacity of 31 kg (69 lbs) with the mount weight of 8.6 kg (19 lbs, include dovetail saddle)
- CNC machined
- Unique friction brake to safely stop movement during a planned or unplanned power interruption
- 270 second gear period
- Built-in, open source iMate™ computer with WiFi, preloaded KStars/Ekos/INDI driver and iPolarServ
- iMate with 3X 12V DC outputs (2 programmable), 2X USB2.0 and 1X USB3.0 ports
- No cable drags
- High precision encoder with real time PEC (RPEC) for HAE69B EC
- Go2Nova® handset with OLED display for better user experiences, especially at extreme temperatures (optional for some models)
- iPolar electronic polar scope for easy and accurate polar alignment (optional)
- Vixen/Losmandy-D dual saddle
- Built in zero position search and locator
- Power down position and location memory
- Integrated ST-4 autoguiding port
- USB-C ports for firmware upgrade and computer control
- Carrying case

- Two year warranty
- Optional LiteRoc tripod (#8023ACC), or Tri-Pier (#8034)
- Optional pier extension (#8043)
- Optional iGuider™ autoguiding system (#3360)
- Optional counterweight shaft (#P-SGP-CWS) and counterweight (#3006-10)

2. HAE69B Terms

2.1. Parts List¹

SHIPPING CONTENTS

Your new HAE69B mount comes in one shipping box:

- HAE69B iMate (#HE692B) or HAE69BEC iMate (HE694B)
- AC adapter 100V-240V, 12V/6A DC output (5.5mm/2.1mm plug, for indoor use only)
- USB-C cable for computer connection and firmware upgrade
- Go2Nova[®] 8411 handset with USB-C port and control cable (for a mount with optional handset)
- Carrying case

OPTIONAL PARTS

- LiteRoc tripod (#8023ACC), or Tri-Pier (#8034)
- iGuider 1 mini autoguiding system (#3360)
- Pier extension #8043
- Counterweight shaft (#P-SGP-CWS) and counterweight (#3006-10)

ONLINE RESOURCES (*click on the “Support” menu at www.iOptron.com*)

- Updated Quick Start Guide
- Instructional manual
- Operation manual for KStars/Ekos
- Tips for set up
- Mount and handset firmware upgrades (check online for latest version)
- iOptron ASCOM driver and computer control
- Reviews and feedback from other customers
- Accessories

¹ US market only. Actual contents, design and function may vary.

2.2. Identification of Parts

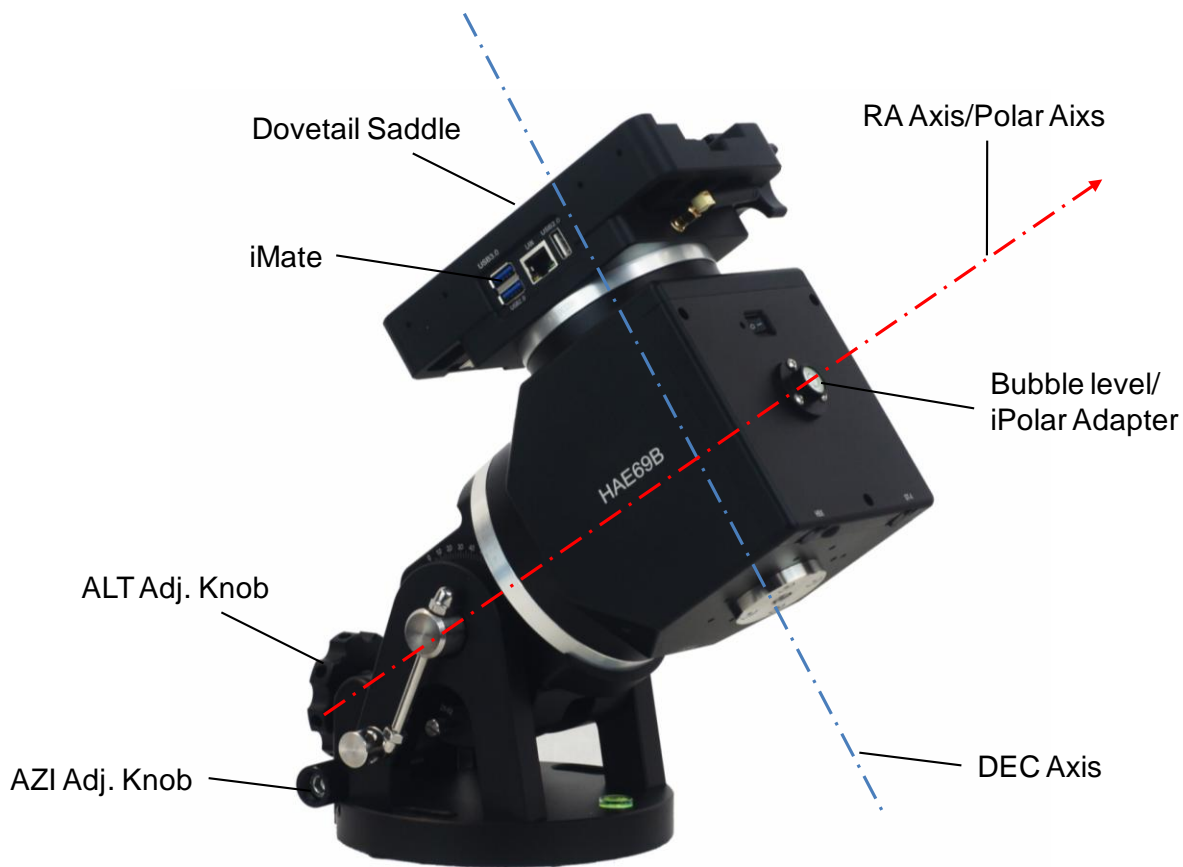

Figure 1. HAE69B mount assembly

2.3. HAE69B Mount Ports

Ports on an HAE69B mount:



Ports on EQ base
(a)



(a) Ports on mount

Figure 2. Ports on an HAE69 mount

- DC 12V IN: DC power socket to power the mount (5.5mmX2.1mm/5521, center positive)
- USB 2.0: USB-C type port for firmware upgrade and computer control
- I/O: Power switch
- HBX (Handbox): For connecting to an 8411 handset
- ST-4: ST-4 compatible autoguiding port. The wiring is shown in Figure 3

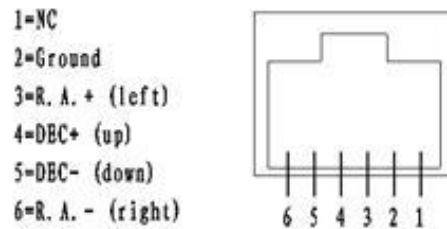

Figure 3. ST-4 Compatible Guiding Port Wiring

Ports on the iMate:



Figure 4. iMate Ports

- Port #3, 2, 1 above iMate: DC 12V outputs DC3, DC2 and DC1, with 5.5mm/2.1mm sockets. DC3 is always on, with a 3A max. output current. DC2 and DC1 can be turn ON/OFF via iMate App, with 2A max. output for each port.
- USB3.0: USB3.0 port for an accessory

- USB2.0 (blue): USB 2.0 for an accessory
- USB2.0 (white): USB 2.0 port for an accessory
- LAN: Ethernet connection (for customer DIY)
- Reset: iMate reset button
- TF: TF port for a class 10 or higher high-speed microSD card, up to 64GB

2.4. HAE69B Mount Control

There are three ways to control an HAE69B mount:

1. Use an 8411 handset;
2. Use a PC/MacOS/Linux/iOS/Android device to connect to the iMate and control the mount using preloaded, open-source KStars/Ekos planetarium software. A handset is not needed; or
3. Use a PC/MacOS/Linux (including Pi) device to connect to the mount via USB-C port on mount and control the mount using ASCOM/Commander or INDI drivers. A handset is not needed.

3. HAE69B Mount Assembly

HAE69 is operated under unbalanced condition and could be tipped over if tripod is not secured.

Step 1. Set up tripod

Carefully remove the mount from the carrying case. The HAE69 has a 150mm base. An optional LiteRoc tripod #8023ACC or a tri-pier #8034 may be used. Setup and level the tripod. Adjust the tripod height. Tighten tripod locking knob to secure the tripod. Remove the **Alignment Peg** from the mount base and threaded it onto the tripod head, on top of a tripod leg or between two legs depending on the latitude. The two outside threaded holes are used for securing the mount head using Azimuth Locking Screws.

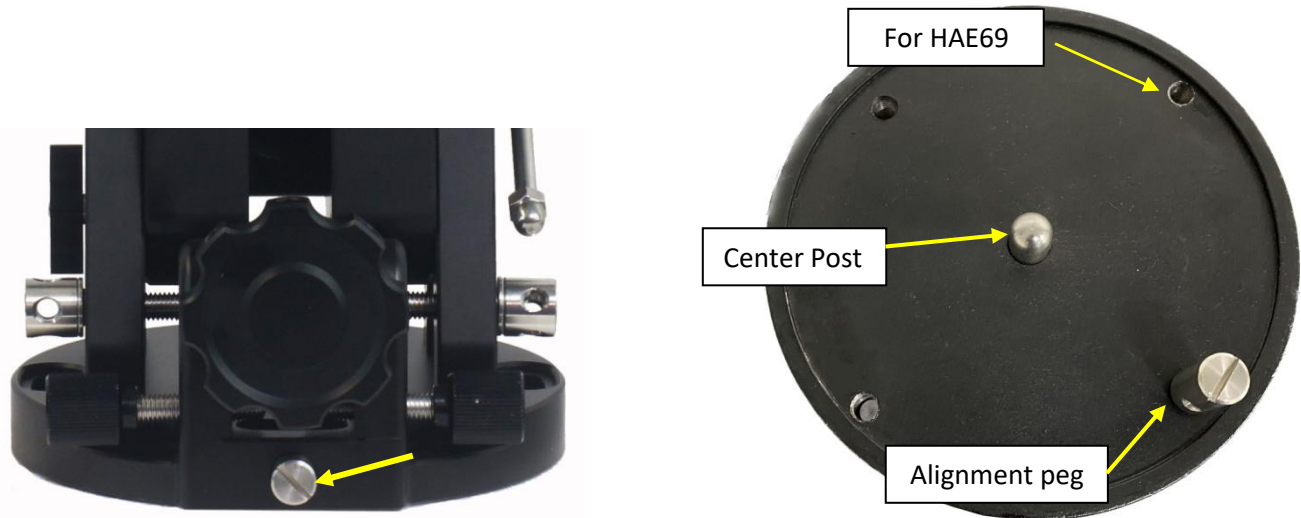
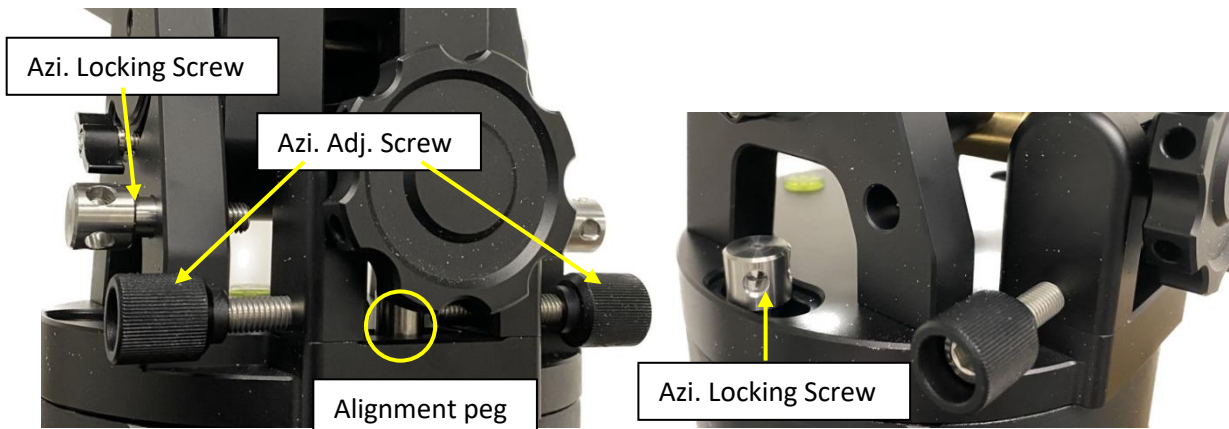

Figure 5. LiteRoc tripods

Step 2. Attach mount head

Remove the mount from the package. Retract the 2x Azimuth (Azi) Adjustment Screws from both sides to leave ample space for the alignment peg to be fitted in between the 2x Azi Adj. Screws. Remove the 2x Azi Locking Screws from the mount base and insert them into the opening next to Azi Adj. Screw. Secure the mount head by tightening the Azi Locking Screws into the M8 holes on the tripod. An Allen wrench is stored in the EQ base if needed.



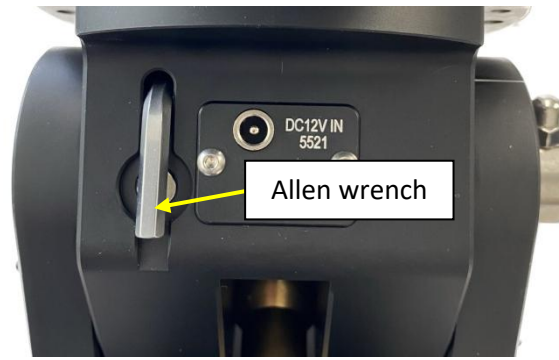

Figure 6. Attach the mount

Level the mount by adjusting the tripod legs. Use the build-in Bubble Level Indicator on the mount base or an external leveler for this purpose.

Step 3. Adjust latitude

The HAE69 mount has three latitude range settings: 0°~34°, 28°~62° and 56°~90°. The default position is 28°~62°.

To adjust the latitude, loosen both the Primary and Auxiliary Alt. Locking Lever on the RA base. Use the Altitude Adjustment Knob to move the mount to the desired latitude by aligning the scale to the Latitude Mark line. Tighten both Primary and Auxiliary Locking Lever. There are holes on the Altitude Adjustment Knob. An Allen wrench may be inserted for increased adjustment torque, if needed.

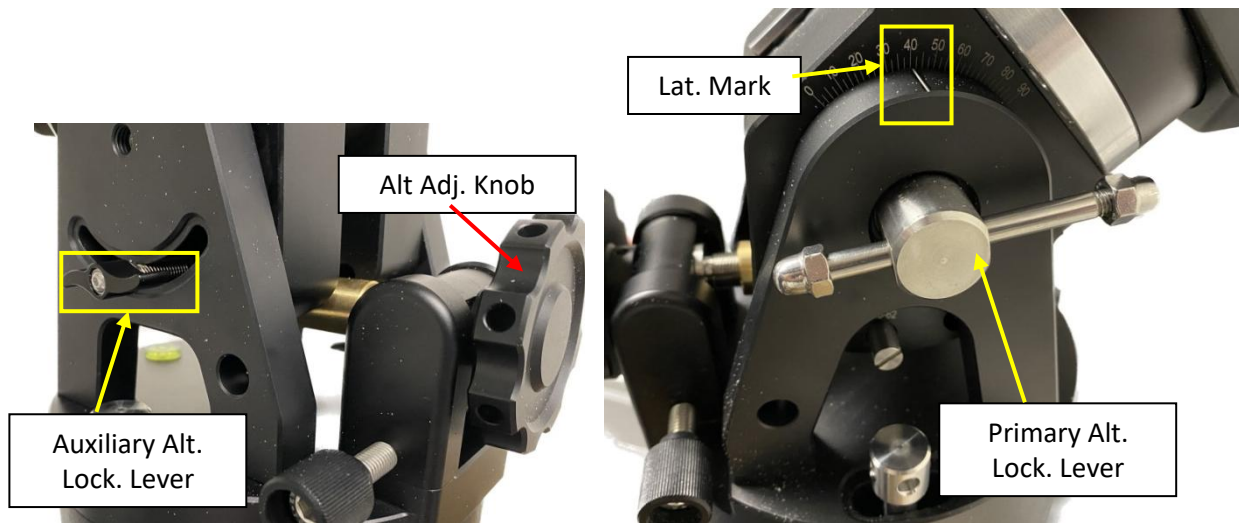

Figure 7. HAE latitude adjustment

If your latitude is out of the 28°~62° latitude range, you may switch the range as following (from: 28°~62° to 56°~90°)

1. Remove any payload from the mount. Loosen Altitude Locking Levers.
2. Adjust the mount latitude so both ranges can be seen inside the RA base.

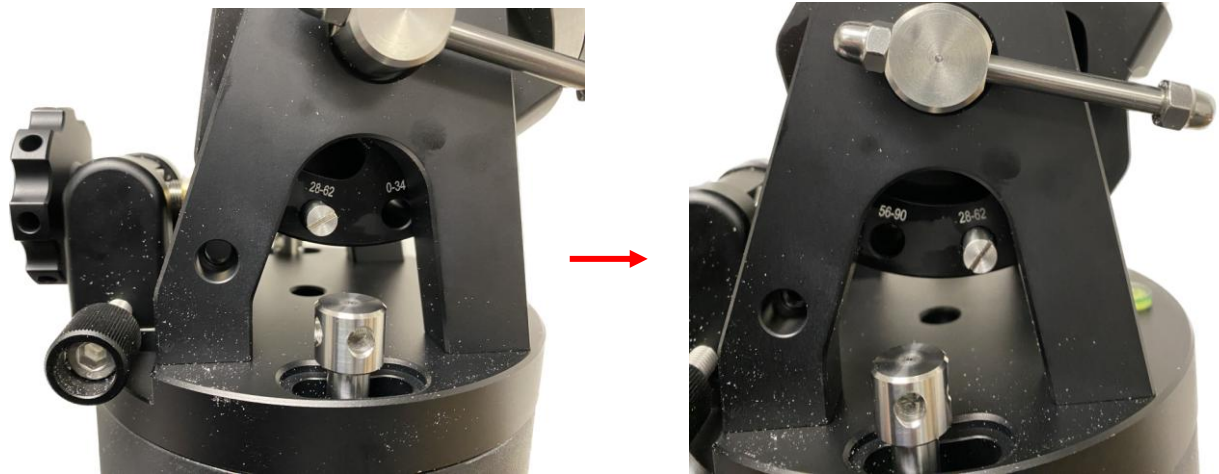

Figure 8. HAE69 latitude range switching

3. Remove Latitude Range Locking Bolt

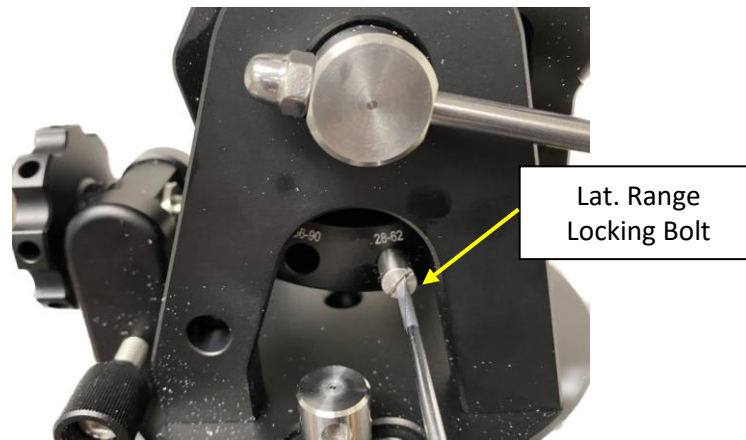

Figure 9. Remove latitude range locking bolt

4. Adjust the mount so that the hole on the brass Latitude Adjustment ball are aligned to 56°~90°



Figure 10. Adjust mount and align the range holes

5. Insert Locking Bolt into 56°~90° and fine adjust the Latitude Adjustment Knob so the bolt will go through the brass ball and threaded into the hole on the other arm of the RA base.

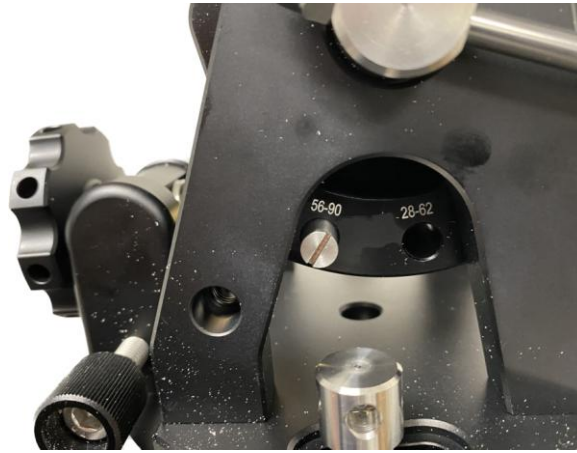

Figure 11. Secure the bolt

6. Tighten the Range Locking Bolt. Now you can adjust the mount between 56° ~ 90°

To use the mount near equator, set it to 0° ~ 34° . To use the mount at AA mode, use the range 58° ~ 90° .



Figure 12. An HAE69 mount set for equator (0° , left) and altazimuth (90° , right)

Step 4. Install telescope

HAE69 is equipped with a Vixen/Losmandy-D dual dovetail saddle. It accepts a Vixen or a Losmandy-D dovetail mounting bar. Release the dovetail Saddle Locking Screws and slide the telescope dovetail plate into the. Make sure that the arrow sign on the saddle is pointing forward. Tighten the Saddle Locking screws. Double check the scope to make sure it is installed securely!

Step 5. Install counterweight bar and CW:

The mount is designed to operate without a counterweight (CW). If you want to use an optional CW, the CW shaft mounting hole is 3/8"-16 threaded. Thread in a CW shaft and install a 10 lbs CW.



Figure 13 Install CW shaft and a 10lbs CW

Step 6. Install optional iPolar

An HAE69 may use an external iPolar™ electronic polar scope. Just place the iPolar over the bubble level on top of the mount and secure the thumb screws. Make sure that the arrow key is facing upward.



Figure 14. Install an external iPolar on an HAE mount

Refer to iPolar Operation Manual from iOptron's website to perform the polar alignment:
https://www.ioptron.com/v/manuals/3339_iPolarOperationManual.pdf.

The steps are briefly outlined below:

- Download and install iPolar Software (first time use)
https://www.ioptron.com/v/firmware/3339_iOptron_iPolar.exe;
- Connect a miniUSB cable between the iPolar USB port and a computer USB port;
- Click Connect and start polar alignment by following onscreen instructions.

Step 7. Install optional iGuider (EQ mode only)

There are two sets of 2XM3 threaded holes on the side of the dovetail saddle for mounting an iOptron mini autoguiding system, iGuider 1. Refer to iOptron website for more information on #3360.



Figure 15. iGuider mini-autoguiding system

Step 8. Set the mount in AA mode

An HAE mount can be set as either EQ or AA mode. To set the mount to operate in AA mode:

1. Switch the latitude range to 56°~90°.
2. Adjust the mount latitude to 90 degree by following **Step 3**.
3. Level the mount by adjusting the tripod legs to center the air bubble inside the spirit level. You may slew the mount in AZI direction to check the leveling, during which the air bubble should stay inside the small circle or stay at the same place.



Figure 16. Bubble level for AA mount leveling

4. Adjust/Slew the mount via a handset/Commander/software so that the telescope is pointing to Zenith and dovetail saddle is facing the WEST.
5. **Set the mount to AA mode via Commander or optional handset.**

4. HAE69B Mount Operation via the iMate and KStars/Ekos

An HAE69B mount has already connected to the iMate internally. One can connect to the iMate via iMate Wi-Fi network and Nomachine remote software/App.

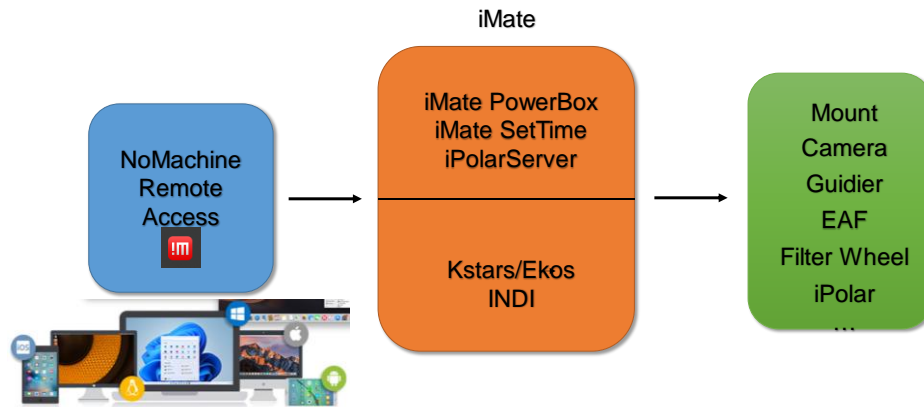
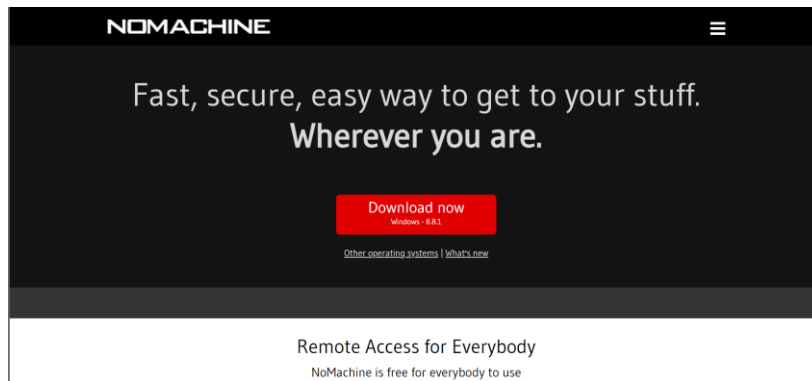

Figure 17. iMate remote access connection

4.1. Initial Set Up iMate for HAE69B

If this is your first time to use the **iMate** on an HAE69B mount, please follow the steps below for initial setup.

1. Download and install NoMachine for Windows, MacOS, Linux, iOS or Android. Here we use Windows as an example:
 - (1) Goto <https://www.nomachine.com> to download NoMachine



- (2) Click on downloaded NoMachine to install the software

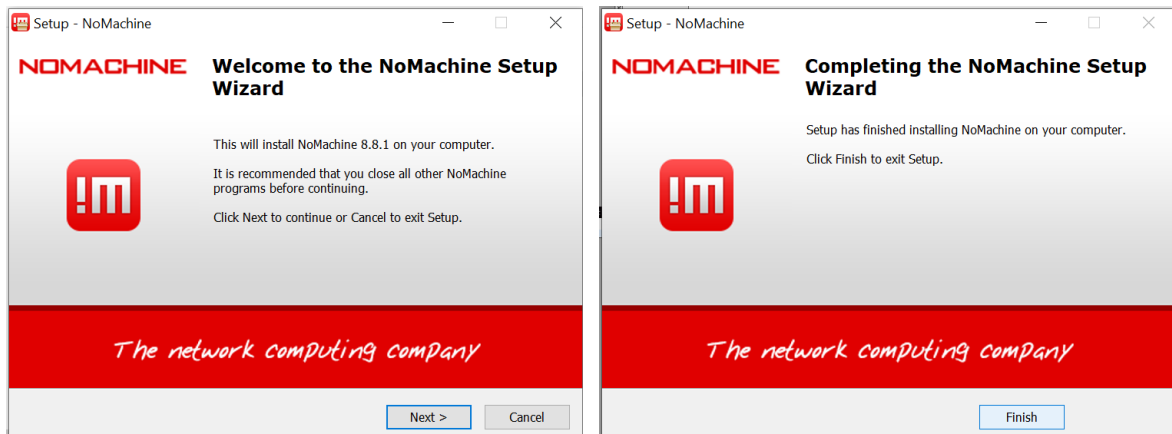

(3) A shortcut will be shown on your computer desktop.

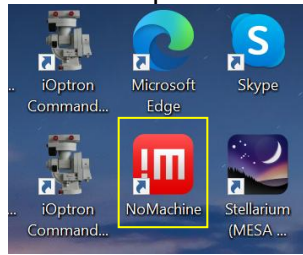

2. Plug DC12V power into DC12V IN on the mount base. Flip the ON/OFF power switch to turn on the mount. The red power indicator next to the switch will be on.



3. From your computer Wi-Fi network list, choose **iMate_XXXXXX**. Enter password **12345678** to connect the computer to iMate Wi-Fi network.

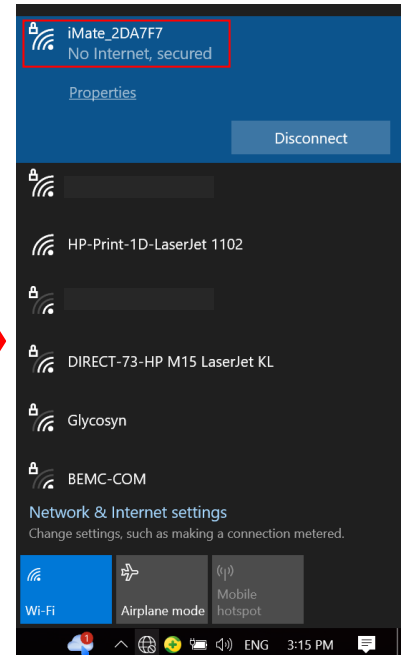
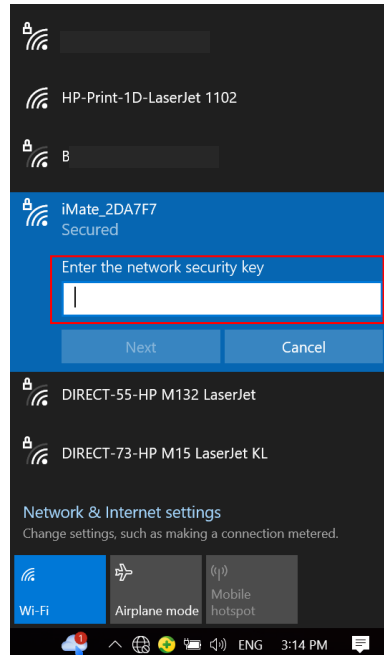
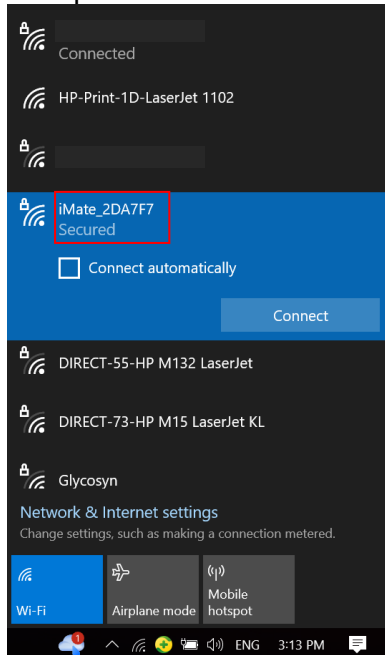

4. Click **NoMachine** shortcut to run the software



- Click **OK** on welcome screens. You may also check the box before “**Don’t show this dialog anymore**” to skip this screen next time running the software.

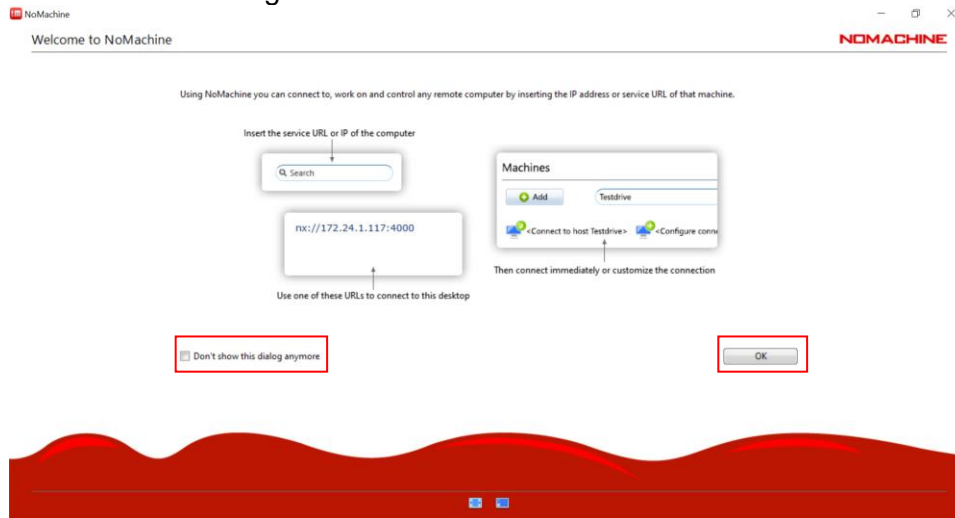

- If the mount is powered on, the “**iMate**” server will be appeared on the screen. Click on **iMate** icon, then click **OK** on next “Verify host identification” screen.

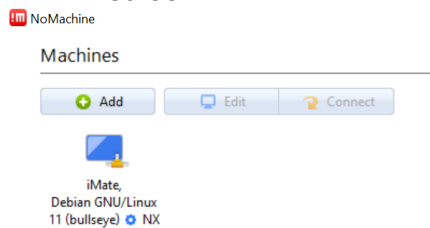

- Enter “**imate**” as both Username and Password to Login on to the iMate Server

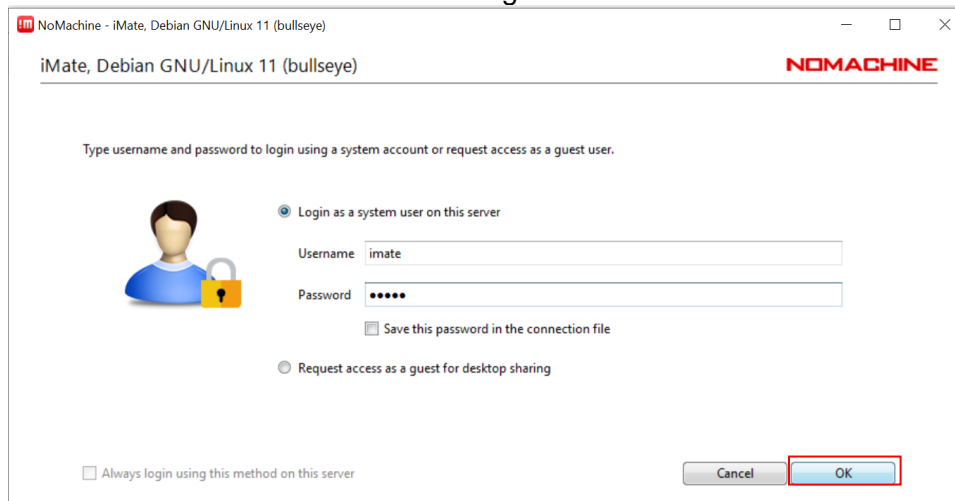

- Click **OKs** to pass the help screens. You may also check the box before “**Don’t show this dialog anymore**” to skip this screen next time running the software.



9. Now the NoMachine will load the software from the iMate. Resize the Windows to adjust for better display. Click on **iOptron Applications** bar on top left corner

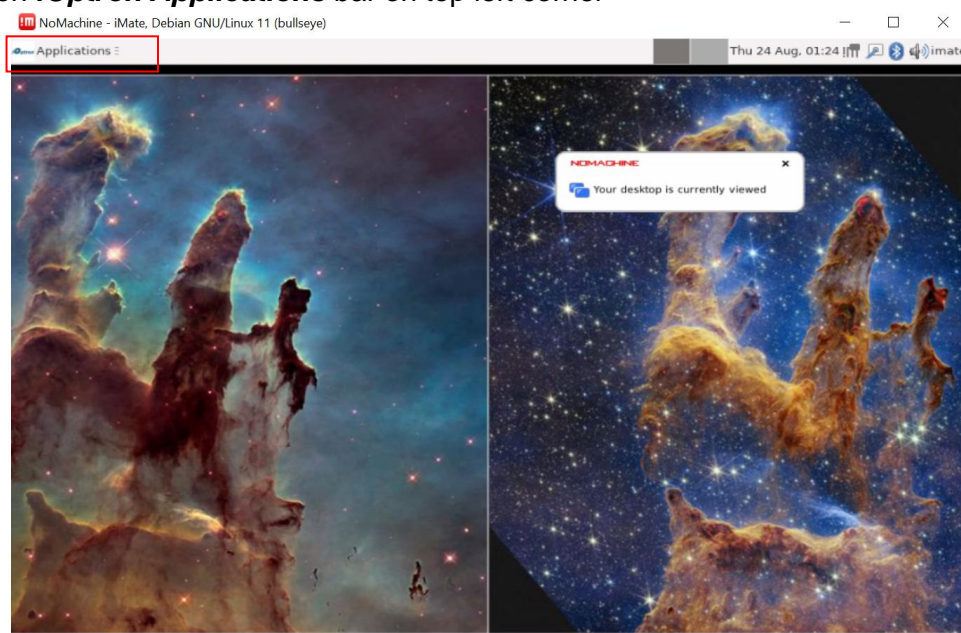

10. From pull down menu to select **Education =>KStars**. Close the tip after the KStars finished loading.

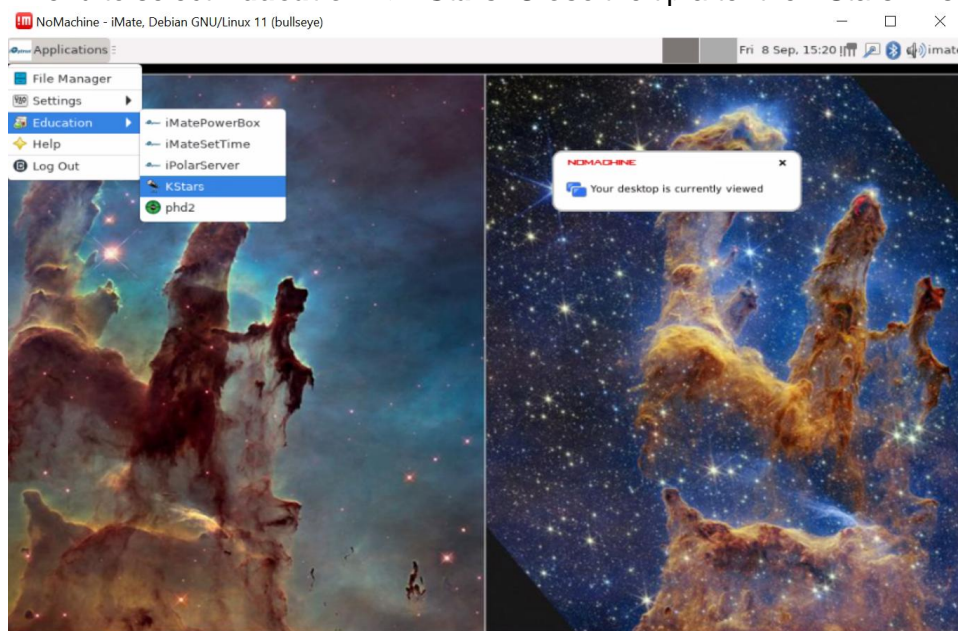

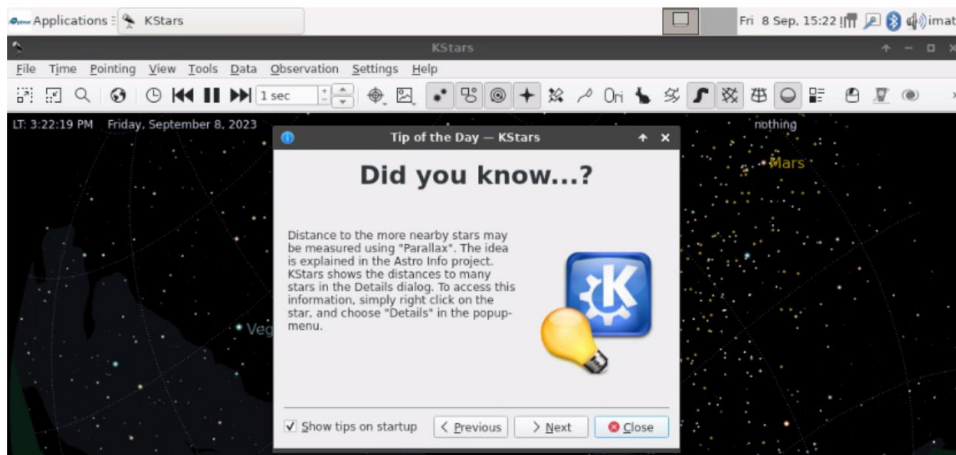

11. Select **Tools=>Ekos**

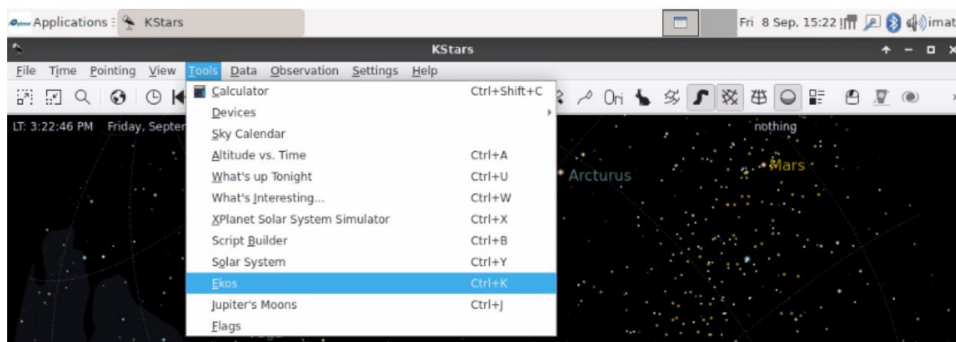

12. Create an Profile by click on “+”

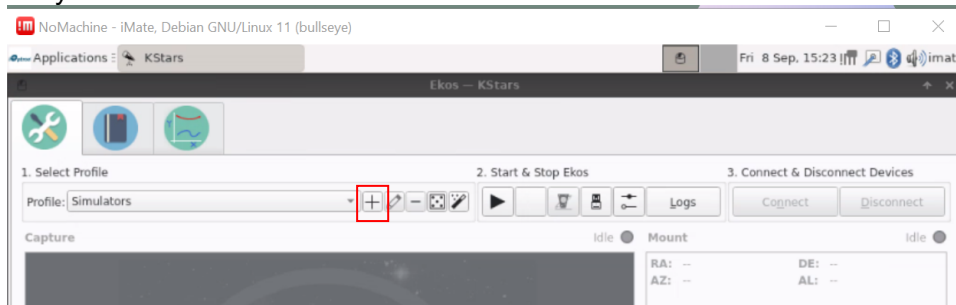

13. Enter the Profile Name, here we use **HAE69B**. Check the Mode as **Local**.

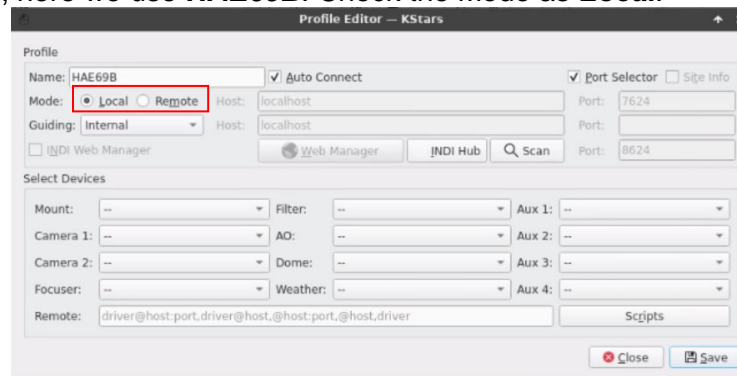

Select **iOptron/HAE69** from **Mount** List.

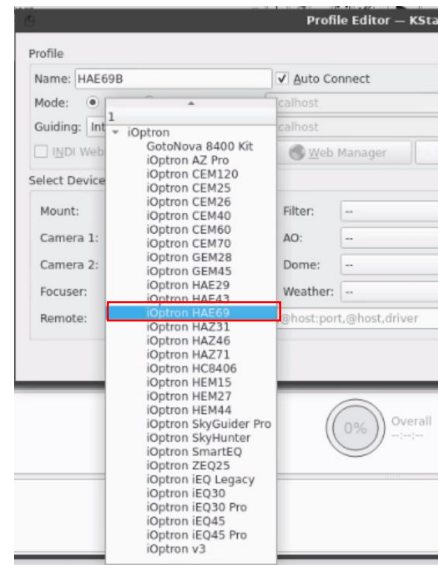
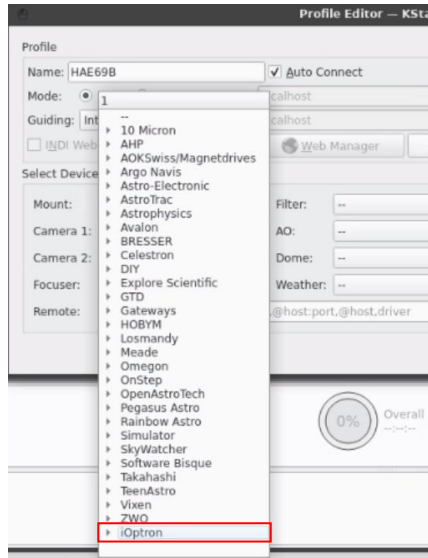

Add a camera from the list (PlayerOne). You have to add at least one camera here; even you do not have the camera attached.

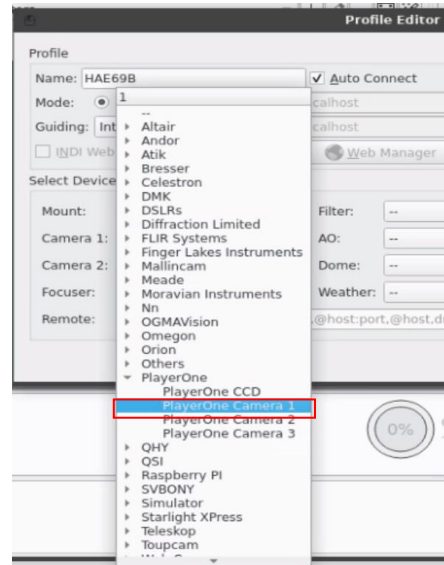
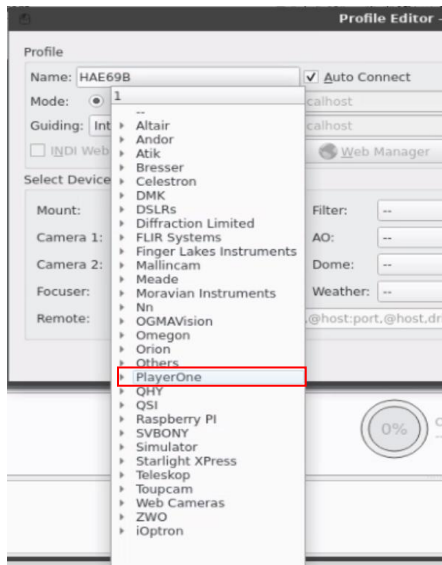

Click **Save** to save the profile. You may add/change other devices later.

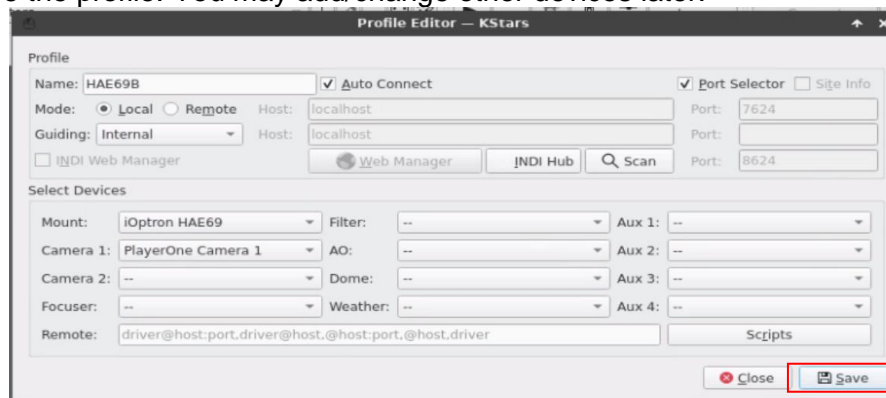

14. Click **Arrow** button to start the **Ekos**. It should connect to the HAE69 and the camera, if it is connected to one of the USB ports.

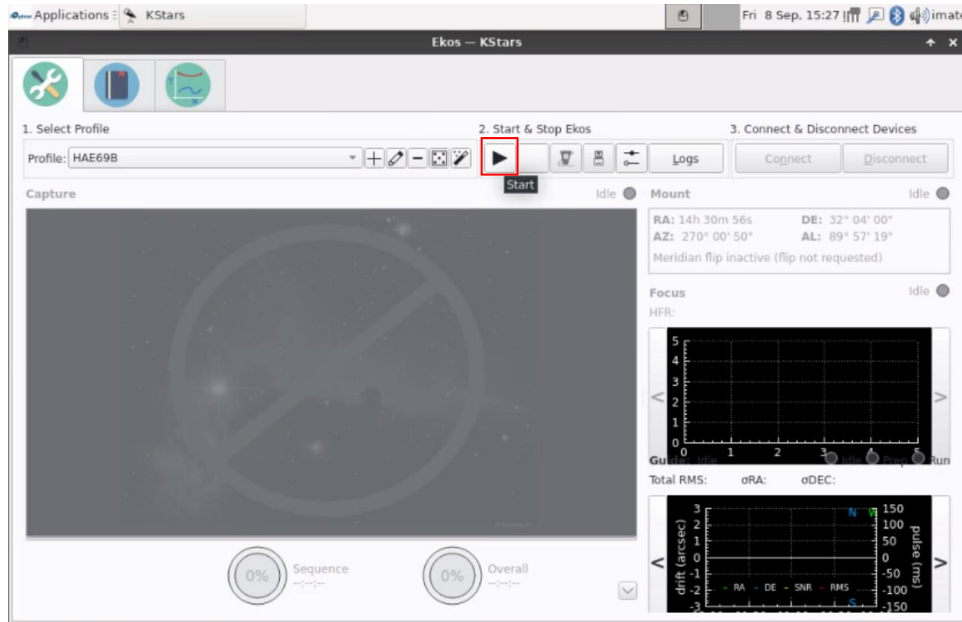

15. Click on Tripod sign to bring up the Mount Control of the Primary Train.

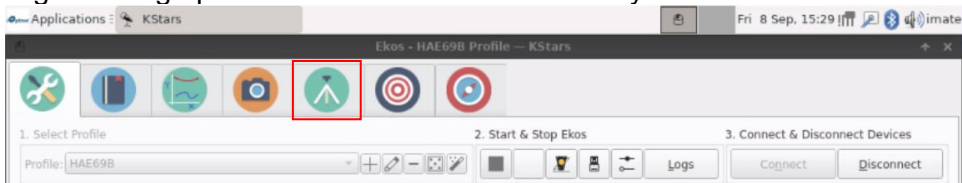

16. Click on Mount Control button to bring up the control pad. Now you can slew the mount.

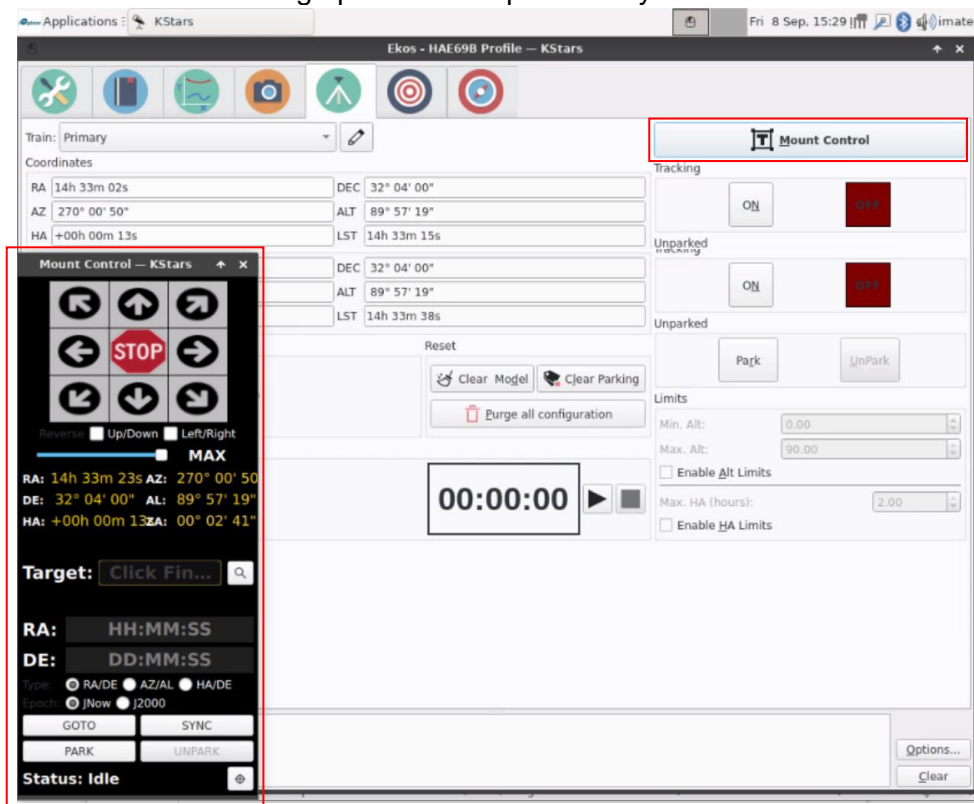

4.2. Operation HAE69B via an iMate and KStars/Ekos

The initial settings, such as time, site and initial position, are the basics to ensure a telescope mount having a good GOTO accuracy. The default is **KStars updates all devices**.

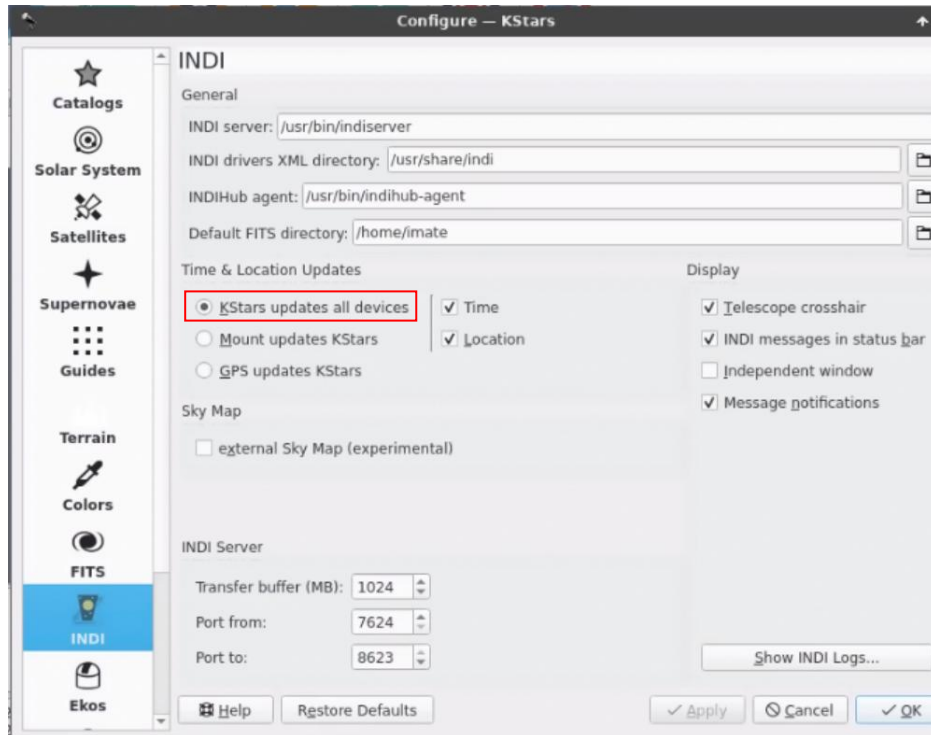

4.2.1. Set up iMate Time

Connect the iMate. The initial time shown here is 8/24/2023 01:26. From **iOptron Applications** pull down menu to select **Education =>iMateSetTime**. This will bring up the imatesettime screen.

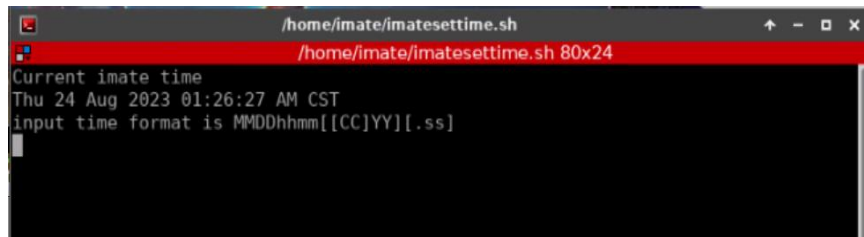
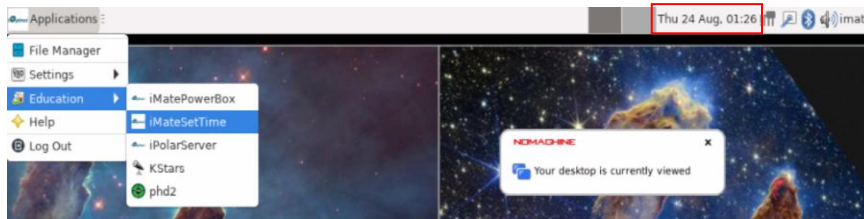

Enter the time in the format MMDDhhmmYYYY.00 or MMDDhhmmYY. Here we entered 0908152023.00, or 0908152023 for Sept 8, 2023, 15:20. Click **Enter** from your keyboard to confirm.

The iMate time won't be kept when the mount is power off.

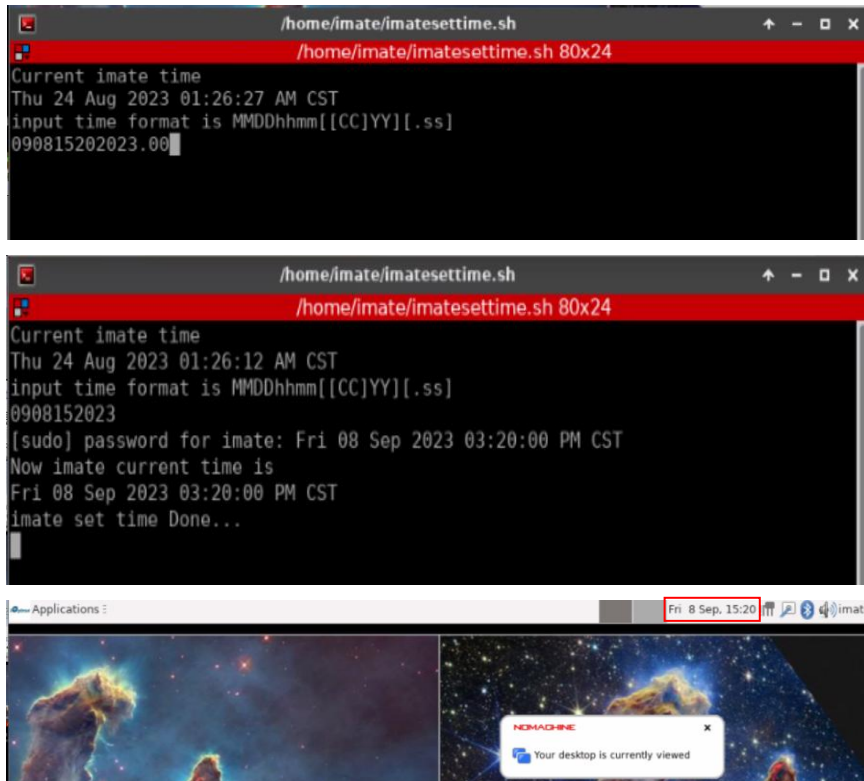

4.2.2. Set up iMate Site Info (GPS location)

From **KStars** main screen, click on **Geographic (global)** button to set geographic location. Enter **“Boston”** in **City filter** and select **“Boston, Massachusetts, USA”**. Choose correct UTC offset, which is -5 hours, and DST rules, which is US. Click OK to save it. You may also manually enter

The location info will be kept in the KStar.

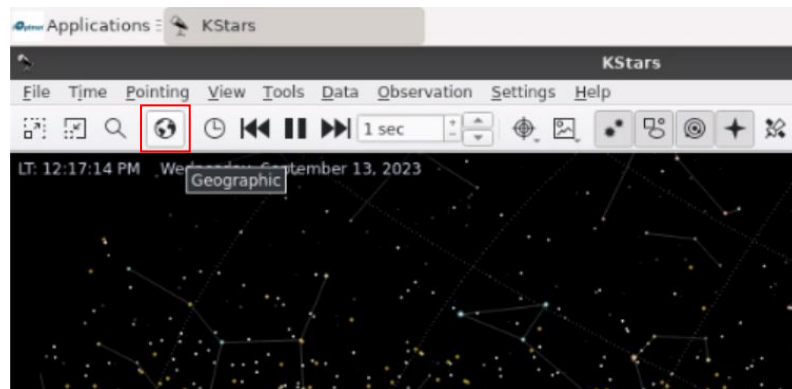

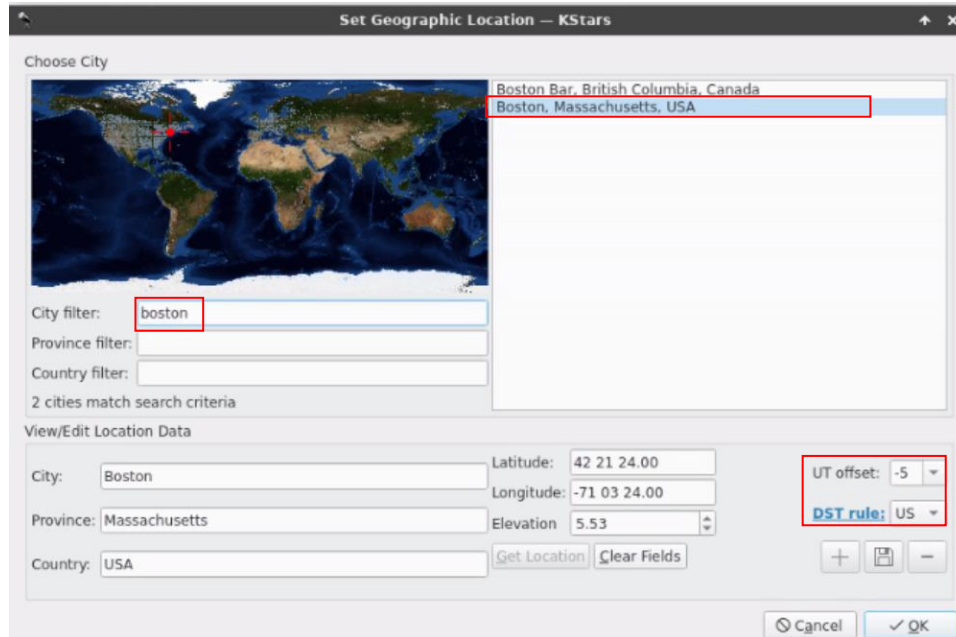

4.2.3. Set up Zero Position

From KStars, select Tools=>Ekos. Click **Arrow** button to start the **Ekos**. This will bring up the **INDI Control Panel**. It will show all connected devices. This panel can be activated by clicking on INDI icon .

Click on Find Home from iOptron HAE69. The mount will perform Searching Zero Position and return to Zero Position. The **Home** status will turn to green.

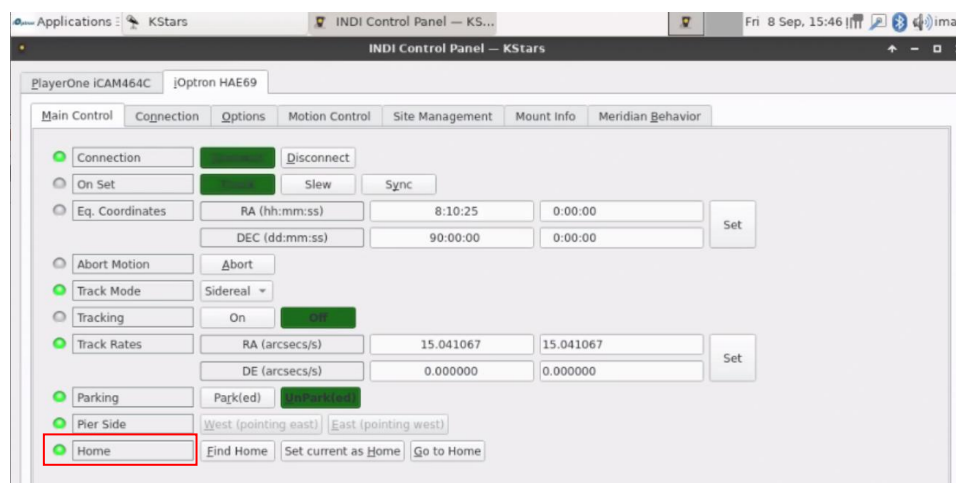
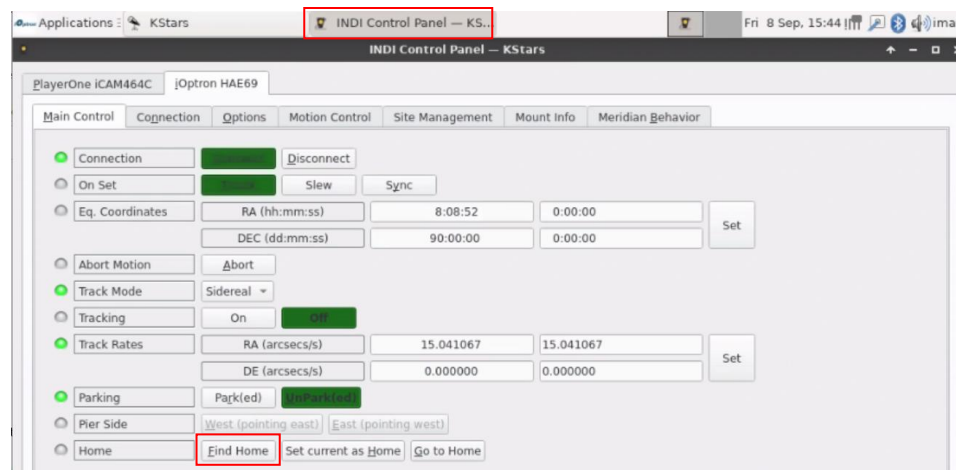

4.2.4. Add Other Devices

Please refer to full KStars/Ekos User Manual for more details.

4.2.5. Polar Alignment

One may use external iPolar, Polar Alignment routine in KStars/Ekos, or a third party software for polar alignment.

4.3. Other iMate Functions

4.3.1. iMate DC Power Output Control

iMate has three (3) DC12V outputs. DC3 is always on. DC2 and DC1 can be programmed ON/OFF. From **iOptron Applications** pull down menu to select **Education =>iMatePowerBox**. This will bring up the imatepowerbox screen.

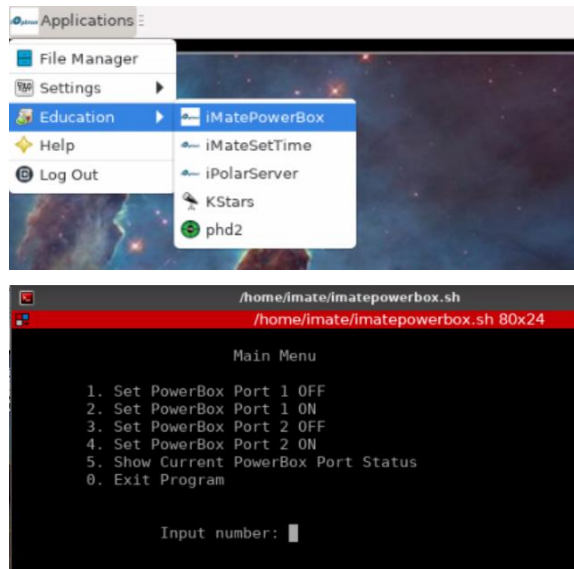

Enter 5 to check the DC1 and DC2 status. “1” is ON and “0” is OFF.

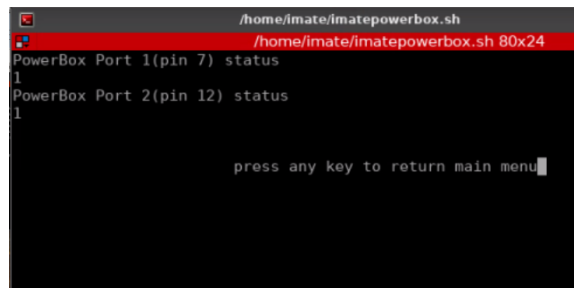

Enter 1 or 2 to turn DC1 power OFF/ON. Enter 3 or 4 to turn DC2 power OFF/ON. Here “1” is entered and the power box DC1 is turned off.

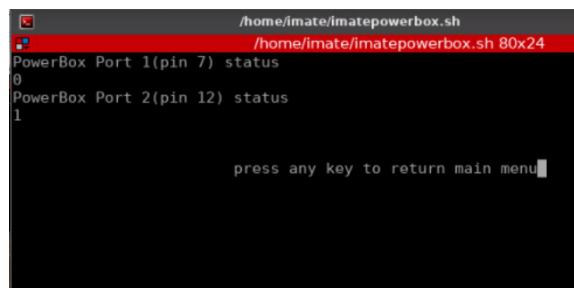

Enter 0 to Exit iMatePowerBox program.

4.3.2. iPolarServer

Plug your iPolar into one of the iMate USB port. From **iOptron Applications** pull down menu to select **Education =>iPolarServer**. The iMate will connect to iPolar camera. After camera is connected, you can perform polar alignment using iOS or Android App.

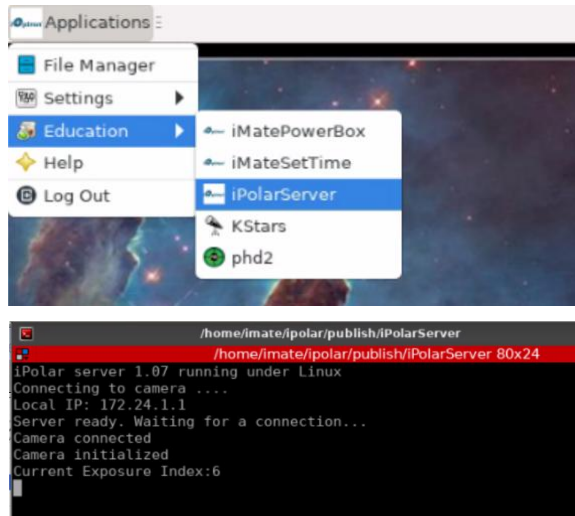

This option only works for iOS. Please download iOS NoMachine and iPolar App for iOS to use this function.

5. HAE69B Mount Operation via an 8411 Handset

5.1. Go2Nova[®] 8411 Handset

A HAE69B mount can be operated via a Go2Nova[®] 8411 handset, as shown in Figure 18. It has an 8-line large OLED display screen function, direction, and number keys on the front; and an HBX (6-pin) and a USB port (C-type) at the bottom.



Figure 18. Go2Nova[®] 8411 handset

5.1.1. Key Description

- MENU Key: Press “MENU” to enter the Main Menu.
- BACK Key: Move back to the previous screen, or end/cancel current operation, such as slewing.
- ENTER Key: Confirm an input, go to the next menu, select a choice, or slew the telescope to a selected object.
- Arrow (▲▼◀▶) Keys: The arrow keys are used to control the movement of DEC and R.A. axes. Press and hold ▲(DEC+), ▼(DEC-) buttons to move a telescope along the DEC direction, ◀(R.A.+), ▶(R.A.-) to move a telescope along the R.A. direction. They are also used to browse the menu or move the cursor while in the menu. Press and holding an arrow key for a fast scrolling.
- Number Keys: Input numerical values. Also used to adjust speeds (1: 1X; 2: 2X; 3: 8X; 4: 16X; 5: 64X; 6: 128X; 7: 256X; 8: 512X; 9: MAX)
- 0 Key: Stop the mount during GOTO. Also toggling between starting and stopping tracking.
- ? Key:
 - Identify and display bright stars or objects that the telescope is pointing to;
 - When on main menu, press and hold ? to turn on/off handset reading light;
 - Press and hold ? during power on to show language selection menu

- HBX (Handbox) port: connect the HC to a mount using a 6P6C RJ11 cable.
- USB port: connect the HC to a computer for firmware upgrade and computer control.

5.1.2. The Display

The 8411 handset has a large 8-line, 21-character per line OLED display, which displays all the information as shown in Figure 19. The user interface is simple and easy to operate.

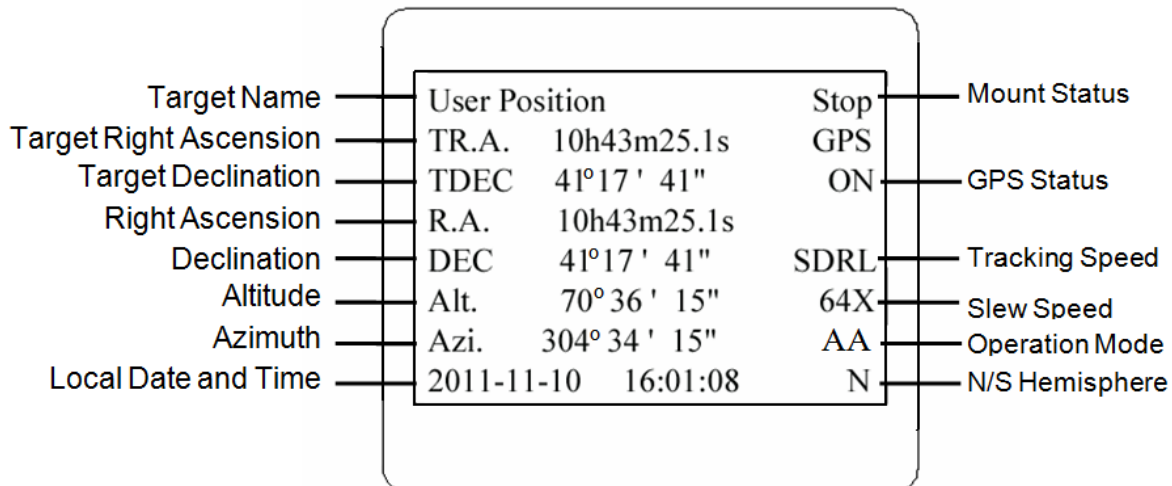

Figure 19. an 8411 handset display

1. Target Name/Mount Position: displays the name of the target that telescope is currently pointed to or the current mount position.
 - An object name, such as “Mercury” or “Andromeda Galaxy”: Name of the Star or celestial object that the mount is currently slewing to, GOTO or tracking;
 - User Position: The mount is point to a user defined position, which could be a real sky object or just simply due to press an arrow key;
 - **Zero Position:** Mount is at Zero Position. When set the mount at Zero Position physically, the handset should display the same.
2. GPS Status: Indicates if there is GPS or GPS is connected to the satellite. If a mount does not have a GPS, the GPS status will be always OFF.
3. Right Ascension: Right Ascension of the telescope, or R.A.
4. Declination: Declination of the telescope, or DEC.
5. Azimuth: Azimuth of the telescope (north is 0°, east 90°, south 180°, and west 270°).
6. Altitude: Altitude of the telescope (degrees vertical from the local horizon - zenith is 90°).
7. Mount Status: Display current operation status of the mount.
 - Stop: mount is not moving;
 - Slewing: mount is moving with an arrow key is pressed or a GOTO command, such as “**Select and Slew**” or “**Goto Zero Position**”;
 - Tracking: mount is at a tracking status;
 - Guiding: mount is under autoguiding.
8. Tracking speed: Display current tracking rates of the mount
 - SDRL: mount is tracking at a sidereal speed;
 - Solar: mount is tracking at a solar speed;
 - Lunar: mount is tracking at a lunar speed;
 - King: mount is tracking at a King speed;

- CSTM: mount us tracking at a customer defined speed.
9. Slew speed: It has 9 speeds: 1X, 2X, 8X, 16X, 64X, 128X, 256X, 512X, MAX.
 10. Current Time: display local time in a format of HH:MM:SS.

5.2. Install and Check the Handset Battery

The handset uses a button battery to keep the Real Time Clock running. The battery is a CR2032 Lithium battery, which is not included due to shipping restrictions.

Open the HC back cover with a good, size 1 (4mm) Phillips Screw Driver. With battery + sign facing up, slide the battery under two small metal hooks on the positive side first. Then push the battery down to make a good contact. Make sure that two spring contacts on the negative side are underneath the battery. If none of the metal pins in battery holder can be seen after battery is installed, the battery is not installed properly.

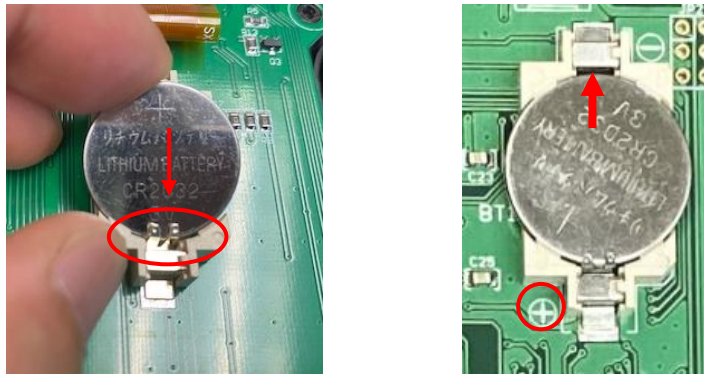

Figure 20. Install a CR2032 battery

If the handset can't display the correct date and time, most likely the battery is installed wrong, or power is low and needs be replaced.

5.3. Connect DC power and handset

Plug the 8411 handset into mount HBX port. Plug DC12V power into DC12V IN on mount base. Flip the ON/OFF power switch to turn on the mount.



Figure 21. Cable connection

Press an arrow key to slew the mount and press a number key to change the slew speed.

5.4. Setup Handset

An HAE69 mount does not equip with a GPS receiver. Hence one needs to manually enter the GPS location.

To set up the controller, turn the mount power ON. Press **MENU**=> **“Settings”**:

```
Select and Slew
Sync. to Target
Alignment
Settings
Park Telescope
Edit User Objects
Firmware Information
Zero Position
```

Press **ENTER** and select **“Set Time and Site”**

```
Set Time and Site
Set Beep
Set Display
Set Maximum Slew Rate
Set Guiding Rate
Set Parking Position
Set Tracking Rate
Meridian Treatment
```

Press **ENTER**. A time and site information screen will be displayed:

```
Daylight Saving Time  Y ← Daylight Saving Time
UTC -300 Minute(s)
2019-03-09 10:19:18

Longitude:W071d08m50s
Latitude: N42d30m32s

Northern Hemisphere
```

Set Local Time

Use the ◀ or ▶ key to move the cursor █ and use the number keys to change the numbers. Use the ▲ or ▼ button to toggle between “Y” and “N” for Daylight Saving Time, or “+” and “-” for UTC (Coordinated Universal Time) setting. Hold the arrow key to fast forward or rewind the cursor.

In order to make the handset reflect your correct local time, **time zone information has to be entered**. Press the ◀ or ▶ key, move the cursor to the third line **“UTC -300 Minute(s)”** to set the time zone information (add or subtract 60 minutes per time zone). For example:

- Boston is “UTC -300 minutes”
- Los Angeles is “UTC -480 minutes”
- Rome is “UTC +60 minutes”
- Beijing is “UTC +480 minutes”
- Sydney is “UTC +600 minutes”

All the time zones in North America are “UTC -”, as shown in the following table, so ensure the display shows **“UTC -”** instead of **“UTC +”** if in North or South America.

Time Zone	Hawaii	Alaska	Pacific	Mountain	Central	Eastern
Hour behind UT	-10	-9	-8	-7	-6	-5
Enter UTC	-600	-540	-480	-420	-360	-300

To adjust minutes, move the cursor to each digit and use the number keys to input the number directly. Use ▲ or ▼ key to toggle between “+” and “-”. When the time information entered is correct, press ENTER and go back to the previous screen. **Note that fractional time zones can be entered.**

Do not manually add or subtract an hour from displayed time to reflect Daylight Saving Time (DST). Instead please select “Y” for DST when daylight saving time begins.

For other parts of the world you can find your “time zone” information from internet.

Set Observation Site Coordinate

The fifth and sixth lines display the longitude and latitude coordinates, respectively. The longitude and latitude coordinates will be automatically updated when the GPS picks up satellite signals. “W/E” means western/eastern hemisphere; “N/S” means northern/southern hemisphere; “d” means degree; “m” means minute; and “s” means second.

Press ◀ or ▶ key to move the cursor and using ▲ or ▼ key to toggle between “W” and “E”, “N” and “S”, using number key to change the numbers. It is always a good idea to do your home work to get the GPS coordinates before traveling to a new observation site.

The site coordinates information can be found from your smart phone, GPS receiver or via the internet. Site information in decimal format can be converted into d:m:s format by multiplying the decimal numbers by 60. For example, N47.53 can be changed to N47°31'48”:
 $47.53^{\circ} = 47^{\circ} + 0.53^{\circ}$,
 $0.53^{\circ} = 0.53 \times 60' = 31.8'$, $0.8' = 0.8 \times 60'' = 48''$. Therefore, $47.53^{\circ} = 47^{\circ}31'48''$ or 47d31m48s.

Select N/S Hemisphere

The northern/southern hemisphere will be determined by your latitude coordinate, with one exception. If you are near the equator (within +/- 10°), you can choose your own N/S setting.

If the polar axis is aligned to the North Celestial Pole, then set the mount to Northern Hemisphere. If the polar axis is pointing to the South Celestial Pole, set the mount to Southern Hemisphere. Press the ◀ or ▶ key to move the cursor and use the ▲ or ▼ key to toggle between “Northern Hemisphere” and “Southern Hemisphere”.

The site information is stored inside the memory chip of the handset and the main board. If you are not traveling to another observation site, they do not need to be changed.

5.5. Zero Position

The **Zero Position** is the mount GOTO reference. Without set the mount zero position properly, it may cause large GOTO error or even cause the scope to hit the tripod leg. The simplest way to find the mount Zero Position of the EQ mode is using the zero position sensors. Press **MENU=>Zero Position =>Search Zero Position**, then press **ENTER**.

The Zero Position of an EQ mount is defined as the telescope being on top of the mount head and pointing to the North Pole (in northern hemisphere), with CW shaft mounting hole pointing to the ground. If one would like to register the Zero Position manually, power on the mount and use handset to slew the mount to Zero Position. Press **MENU=>Zero Position =>Set Zero Position**. Press **ENTER** to confirm.

The Zero Position for the alt-azimuth mode is defined as Level-South-Zenith. Make sure that the mount is leveled, telescope points to Zenith and the dovetail saddle is facing WEST. And the HC is set at AA mode.

5.6. Perform Polar Alignment (EQ mode)

BrightStar Polar Alignment

BrightStar Polar Alignment allows you to perform coarse polar align the mount even if you cannot view the Celestial Pole.

- (1) Level the mount and set it to the Zero Position. Align the telescope to the R.A. axis of the mount. If a finder scope is used, adjust it to be parallel to the telescope optical axis.
- (2) Use the HC (**MENU => "Alignment" => "Polar Iterate Align"**) to display the azimuth and altitude position of several bright stars near the meridian. Select one that is visible at a high altitude as Alignment Star A. Follow the HC instruction to move Alignment Star A to the center of the eyepiece using a combination of the Latitude Adjustment Knob and the "◀" or "▶" buttons. Press **ENTER** to confirm when the star is centered. Next, select a bright star that is close to the horizon as Alignment Star B. Center it using the Azimuth Adjustment Knob and the "◀" or "▶" button (*the "▲" and "▼" buttons are not used here*). Press **ENTER** to confirm the settings.
- (3) The telescope will now slew back to Alignment Star A. Repeat the steps above. The iteration can be stopped when it is determined that the alignment error has been minimized. Press the **BACK** button to exit the alignment procedure.

NOTE: It is highly recommended to use an eyepiece with an illuminated crosshair for accurate centering.

NOTE: The movement of the alignment star in your eyepiece may not be perpendicular depending on its location in the sky.

Polar Alignment with Optional iPolar Electronic Polar Scope

An iPolar™ electronic polar scope can be mounted onto the HAE69B mount. To perform polar alignment, please refer to online **iPolar Operation Menu**. It is simple and fast. Steps are briefly outlined below:

- Download and install iPolar Software (first time use)
- Connect a USB cable between the mount and a computer USB port
- Start polar alignment by following on screen instructions

Or one can use a SmartPhone with iPolarServer loaded in iMate.

Polar Alignment Software

There are software available for polar alignment, such as PHD2 guiding, TheSky software, PemPro, or Alignmaster. Or using Polar Alignment routine from KStars/Ekos loaded in iMate.

5.7. Go To a Celestial Object

Press **MENU=> "Select and Slew"** to perform the GOTO. Select a category, in this example "**Solar System**", and then select an object of interest, in this case "**Moon**". Press **ENTER** and the telescope will slew to the moon and automatically start tracking. If the target is not centered in your eyepiece, use the arrow keys to center it. Then use **MENU => "Sync to Target"** for better performance.

Any object with a "◊" symbol next to it is currently below the horizon and the mount will not slew to it.

5.8. Complete Function of a Go2Nova[®] 8411 Handset

NOTE: Some functions may not be available depending on mount operation mode.

5.8.1. Slew to an Object

Press **MENU** => “**Select and Slew.**” Select an object that you would like to observe and press the **ENTER** key.

The Go2Nova[®] 8411 handset for HAE mount has a database of over 212,000 objects. Use the ► or ◀ buttons to move the cursor. Use the number buttons to enter the number, or the ▼ or ▲ buttons to change the individual number. Hold on a button to fast scroll through the list. The “☉” indicates the object is above the horizon, and a cross mark “⊖” means it is below the horizon. In some catalogs those stars below the horizon will not display on the handset.

5.8.1.1. Solar System

There are 9 objects in the Solar system catalog.

5.8.1.2. Deep Sky Objects

This menu includes objects outside our Solar system such as galaxies, star clusters, quasars, and nebulae.

- Named Objects: consists of 60 deep sky objects with their common names. A list of named deep sky objects is included in Appendix.
- Messier Catalog: consists of all 110 Messier objects.
- NGC Catalog: consists of 7,840 objects in NGC catalog.
- IC Catalog: consists of 5,386 objects in IC catalog.
- UGC Catalog: consists of 12,921 objects.
- Caldwell Catalog: consists of 109 objects.
- Abell Catalog: consists of 4076 objects.
- Herschel Catalog: consists of 400 objects.

5.8.1.3. Stars:

- Named Stars: consists of 259 stars with their common names. They are listed alphabetically. A list is included in Appendix.
- Binary Stars: consists of 208 binary stars. A list is attached in Appendix.
- Hipparcos Catalog: the new HIP catalog consists of 120,404 records (2008).

5.8.1.4. Constellations

This catalog consists of 88 modern constellations with their names. They are listed alphabetically.

5.8.1.5. Comets

This catalog contains 15 comets.

5.8.1.6. Asteroids

This catalog contains 116 asteroids.

5.8.1.7. User Objects

It can store up to 60 used entered objects, including comets.

5.8.1.8. Enter R.A. DEC

Here you can go to a target by entering its R.A. and DEC numbers.

5.8.2. Sync to Target

This operation will match the telescope's current coordinates to Target Right Ascension and Declination. After slewing to an object, press **MENU** => "**Sync to Target**" => **ENTER**. Follow the screen to perform the sync. Using this function will re-calibrate the computer to the selected object.

"**Sync to Target**" will only work after "**Select and Slew**" is performed. You can change the slewing speed to make the centering procedure easier. Simply press a number (1 through 9) to change the speed. The default slew speed is 64X.

5.8.3. Alignment

5.8.3.1. Pole Star Position

This function displays the position of the Pole Star for **Quick Polar Alignment** using the iOptron® AccuAlign™ polar scope. In the Northern Hemisphere the position of Polaris is displayed, while in the Southern Hemisphere the position of Sigma Octantis is shown.

5.8.3.2. Polar Iterate Align

This alignment method allows you to polar align the mount even if you cannot view the Celestial Pole. Press the **MENU** => "**Alignment**" => "**Polar Iterate Align**". The HC will display a list of bright alignment stars near the meridian as Alignment Star A. Follow the HC instructions to move Alignment Star A to the center of the eyepiece using a combination of the Latitude Adjustment Knob and the "◀" and "▶" buttons. Press **ENTER** to confirm the settings. Next, select a bright star that is close to the horizon as Alignment Star B. Center it using the Azimuth Adjustment Knobs and the "◀" and "▶" buttons (*the "▲" and "▼" buttons will not function*). Press **ENTER** to confirm the settings.

The telescope will now slew back to Alignment Star A to repeat the above steps. The iteration can be stopped when it is determined that the alignment error has been minimized. Press the **BACK** button to exit the alignment procedure.

NOTE: It is highly recommended to use an eyepiece with illuminated crosshairs for accurate centering.

NOTE: The movement of the alignment star in your eyepiece may not be perpendicular depending on its location in the sky.

5.8.4. Settings

5.8.4.1. Set Time and Site

Refer to 5.4 Set up Handset.

5.8.4.2. Set Beep

The handset allows a user to turn off the beep partially, or even go to a silent mode. To change this setting press **MENU** => "**Settings**" => "**Set Beep**",

```
Set Time and Site
Set Beep
Set Display
Set Maximum Slew Rate
Set Guiding Rate
Set Parking Position
Set Tracking Rate
Meridian Treatment
```

Select one of three available modes:

"Always On" – a beep will be heard on each button operation or mount movement;

"On but Keyboard" – a beep will be heard only when the mount is slewing to the object or there is a warning message;

"Always Off" – all sounds will be turned off, including the SUN warning message.

5.8.4.3. Set Display

Press **MENU** => **"Settings"** => **"Set Display,"**

```
Set Time and Site
Set Beep
Set Display
Set Maximum Slew Rate
Set Guiding Rate
Set Parking Position
Set Tracking Rate
Meridian Treatment
```

Use the arrow keys to adjust LCD display contrast (**LCD contrast**), LCD backlight intensity (**LCD light**), and keypad's backlight intensity (**Key light**).

5.8.4.4. Set Maximum Slew Rate

This function will help the mount to slew properly under low temperature or extreme payload condition (extra long or large diameter scope). Press **MENU** => **"Settings"** => **"Set Maximum Slew Rate,"** You can select one of three slew rates. The default is MAX.

5.8.4.5. Set Guiding Rate

This is an advanced function for autoguiding when a guiding camera is utilized either via a Guide Port or using the ASCOM protocol. Before autoguiding, align the polar axis carefully. Select an appropriate guiding speed. The latest firmware allows you to set the R.A. and DEC guiding speed differently. The R.A. guiding speed can be set between $\pm 0.01X$ to $\pm 0.90X$ sidereal rate. The DEC guiding speed can be set between $\pm 0.10X$ to $\pm 0.99X$ sidereal rate. Follow the instructions of your autoguiding software for detailed guiding operation. The default number is 0.5X.

The guide port wiring is shown in **Figure 3**, which has the same pin-out as that from Celestron / Starlight Xpress / Orion Mount / Orion/ QHY/ZWO autoguider camera.

If you have an autoguider which has a pin-out the same as the ST-I from SBIG, such as Meade/ Losmandy/ Takahashi/ Vixen, make sure a proper guiding cable is used. Refer to your guiding camera and guiding software for detailed operation.

WARNING: DO NOT plug your ST-4 guiding camera cable into the HBX port. It will damage the mount or guiding camera electronics.

5.8.4.6. Set Parking Position

You may park the telescope before powering off the mount. This is very useful if the mount is on a permanent pier or the mount will not be moved in between observation sessions. The mount will keep all the alignment info and reference points.

There are five parking positions. Two positions that park the scope horizontally (**Horizon Position**). Two positions that park the scope vertically (**Zenith Position**). "**Current Position**" will park the scope at its current position. When the mount is turned on, it will use the last parking position setting as the default setting.

5.8.4.7. Set Tracking Rate

You can set up the mount tracking rate by selecting "**Set Tracking Rate**". Then the user can select "**Automatic Rate**" to let the mount choose a proper Solar/Luna/Sidereal tracking rate based on the GOTO target. The "**User defined speed**" can be adjusted from 0.9900X to 1.0100X of sidereal.

5.8.4.8. Meridian Treatment

This function tells the mount what to do when it tracks past the meridian. You can tell the mount if it needs a meridian flip and when to do it.

- "**Set Position Limit**" will tell the mount when to stop tracking or to do a meridian flip. The limit can be set at from 0° to 15° (60 minutes) past meridian.
- "**Set Behavior**" will determine if the mount will stop tracking or perform a meridian flip at the set position limit.

5.8.4.9. Set Altitude Limit

This function allows the mount to keep tracking an object even if it is below the horizon but can still be seen, for example from an elevated observation site, such as a hill. The range can be set from -89° to +89°. The default limit is 00°. **Be careful when setting this limit.** It may cause mount GOTO problems.

5.8.4.10. Set RA Guiding (EC mount Only)

You can turn off R.A. guiding by selecting "**Filter R.A. Guiding**" to allow the high precision encoder to correct the tracking error, or turn the R.A. guiding on by selecting "**Allow RA Guiding**" to allow the mount to receive guiding corrections from the autoguiding software.

5.8.4.11. Language

Select one of supported menu languages. Currently it has English and Chinese. You can press and hold ? button during power on to show language selection menu.

5.8.4.12. Enable CW Up Position

This setting will allow the CW moving to an up position. The upward angle limit is same as the meridian flipping setting, or 20 degree at maximum. When this set is enabled, the mount will GOTO past the meridian if an object is close to the meridian, within the angle limit. There will be no meridian flip when past the meridian.

5.8.4.13. Enter AA/EQ Mode

This setting will switch the mount between AA/EQ mode.

5.8.5. Edit User Objects

Besides various star lists available in the handset, you can add, edit or delete your own user-defined objects. This is especially useful for newly found comets. You can also add your favorite observation object into the user object list for easy sky surfing. Up to 60 comets and other user objects can be stored.

5.8.5.1. Enter a New Comet

Press **MENU** => "**Edit User Objects**" to set user objects.

```
User Defined Comet
Other Objects
```

Select "**User Defined Comet**" to add/browse/delete the user-defined comet list. Find the orbit parameters of a comet in the SkyMap format. For example, the C/2012 ISON has an orbit parameter:

No.	Name	Year	M	Day	q	e	ω	Ω	i	H	G
C/2012	S1 ISON	2013	11	28.7960	0.0125050	1.0000030	345.5088	295.7379	61.8570	6.0	4.0

Select "**Add a New Comet**" to add a new one:

```
Add a New Comet
Browse Comets
Delete a Comet
Clear All Comets
```

The handset will display the parameter entry screen:

```
Comet Parameter
Date: 0000-00-00.0000
q: 0.0000000
e: 0.0000000
 $\omega$ : 000.0000
 $\Omega$ : 000.0000
i: 000.0000
```

Enter the parameters using the arrow buttons and number keys. Press **ENTER** and a confirmation screen will be displayed. Press **ENTER** again to store the object under the assigned user object number, or press **BACK** button to cancel.

5.8.5.2. Enter Other Objects or Observation List

Press **MENU** => "**Edit User Objects**" to set user objects.

```
User Defined Comet
Other Objects
```

Select "**Other Objects**" to enter you own object:

```
Add a New Object
Browse Objects
Delete an Object
Clear All Objects
```

Select "**Add a New Object**". A screen will be displayed asking you to Enter R.A. and DEC coordinates:

```
Enter RA and DEC
RA      07h57m22.7
DEC     +90°00'00"
Alt     42°21'24"
Azi     000°00'00"
```

You may enter the R.A. and DEC coordinates of the object you want to store, and press **ENTER** to confirm.

A more useful application of this function is to store your favorite viewing objects before heading to the field. When the "**Enter R.A. and DEC**" screen appears, press the **MENU** button. It brings up the catalogs that you can select the object from. Follow the screen instructions to add your favorite objects. Press **BACK** button to go back one level.

Press the **BACK** button to go back to the object entry submenu. You may review the records or delete those that are no longer wanted. Press the **BACK** button to finish the operation. Now you can slew to your favorite stars from "**Custom Objects**" catalog using "**Select and Slew**."

5.8.6. Firmware Information

This option will display the mount type, firmware version information for the handset (HC), R.A. board (RA), and DEC board (DEC).

5.8.7. Zero Position

5.8.7.1. GoTo Zero Position

This moves your telescope to its Zero Position what the handset thinks it should be. At the end of move, the mount needs be adjusted if the mount is not at Zero Position physically.

5.8.7.2. Set Zero Position

This sets the Zero Position for the firmware.

The Zero Position reference may be an undefined value before the first time powering on the mount, after firmware upgrade, or HC battery replacement. You can use this function to set the zero position reference.

Press the **ENTER** button after moving the mount to Zero Position either manually or with the handset.

5.8.7.3. Search Zero Pos.

Select "**Search Zero Pos.**" and the mount will start to slew slowly and find the R.A. and DEC position to set the mount to the Zero Position. When the mount has found the Zero Position, the HC will ask if you want to calibrate the Zero Position. Press **ENTER** to confirm. Use the arrow button to adjust the mount in RA and DEC to correct the obvious discrepancy in the Zero Position. Alternatively, press **BACK** to cancel.

6. HAE69B Mount Operation via iOptron Commander

An HAE69B mount can also be operated by connecting to a Windows PC via ASCOM, a MacOS or Linux computer via INDI driver, or a single board computer like Pi. Connect the mount to a computer via the USB-C port on the mount base. Install drivers and software and you are ready to go. No handset is needed.

6.1. Download and Install ASCOM Platform and Commander

Here is an example on how to connect an HAE69B to a Windows PC using iOptron Commander/ASCOM driver. The software/firmware needed:

- Windows 7 /8.1 /10/11 64bit system with .NET Framework 4.8 installed. For Win10 and 11, make sure that .NET Framework 3.5 is activated.
- ASCOM Platform 6.6 or late version. Download and install it from <http://www.ascom-standards.org>;

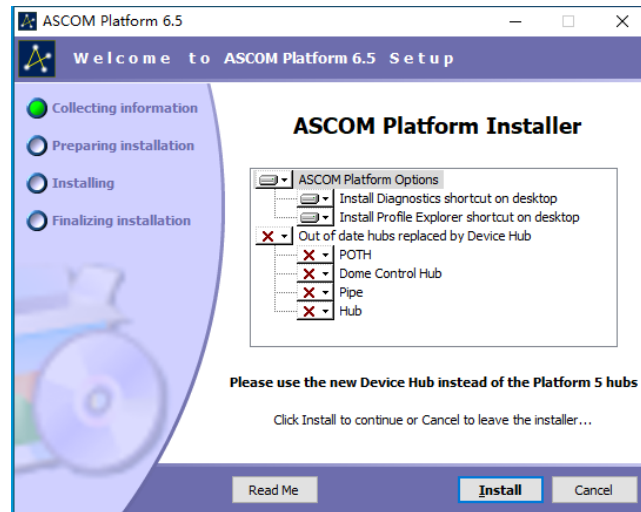

- iOptron Commander and ASCOM Driver Installer 9.1 or later. Download and install it from the device product page.

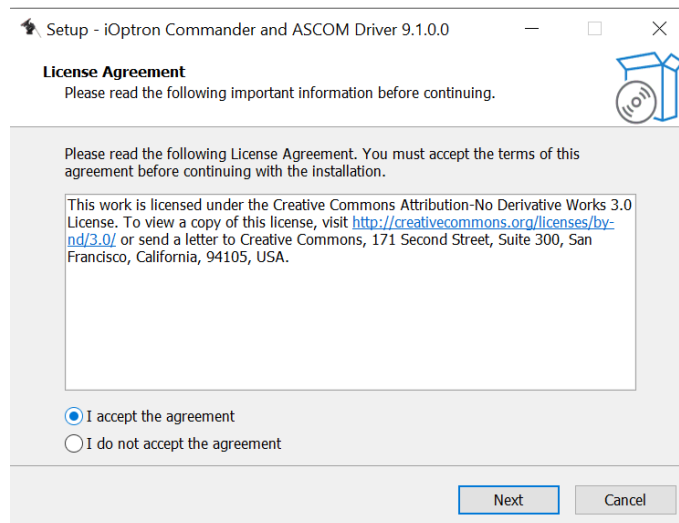

After installation, you should see an iOptron Commander icon like this on your computer desktop.

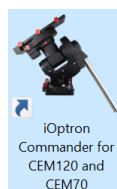

- Latest mount firmware

6.2. Connect HAE69B to a Computer

Plug a DC12V power into DC12V IN on mount base. Connect the USB 2.0 port on the base to a computer USB port via a USB-C cable. Flip the ON/OFF power switch to turn on the mount.



6.3. Use iOptron Commander

6.3.1. Connect the mount via Commander

Click on iOptron Commander icon  on desktop to launch the Commander. An **iOptron Commander Connection Setting** window will open:

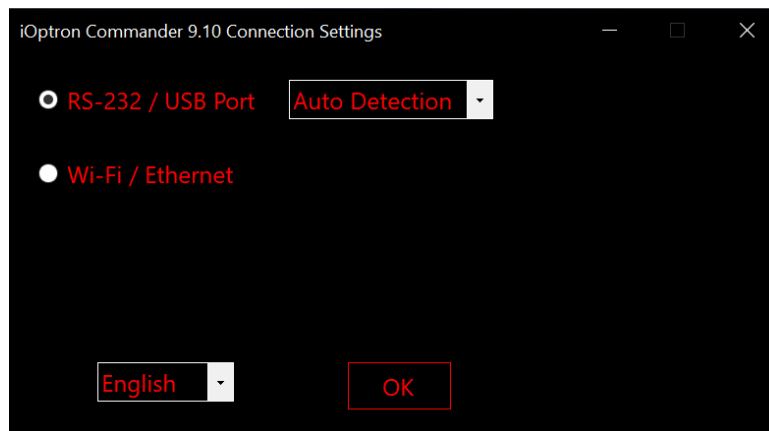

Select “**RS-232/USB Port**” with “**Auto Detection**”, or click on the RS-232/USB Port pull down menu to select a COM port manually. The COM6 is selected as shown below.

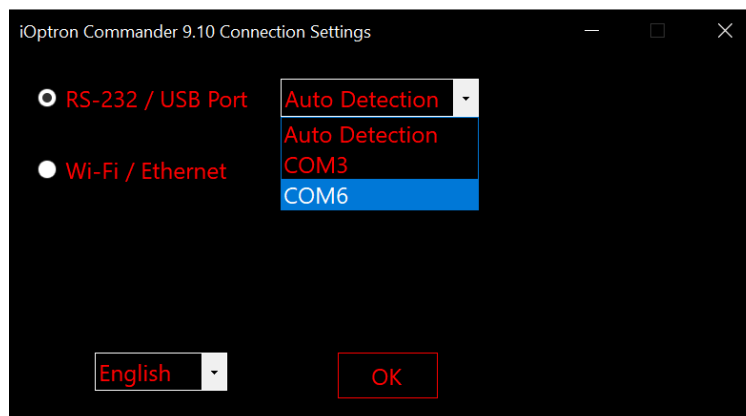

Click **OK** to connect. An iOptron Commander connection panel will display when the computer connected to the mount.

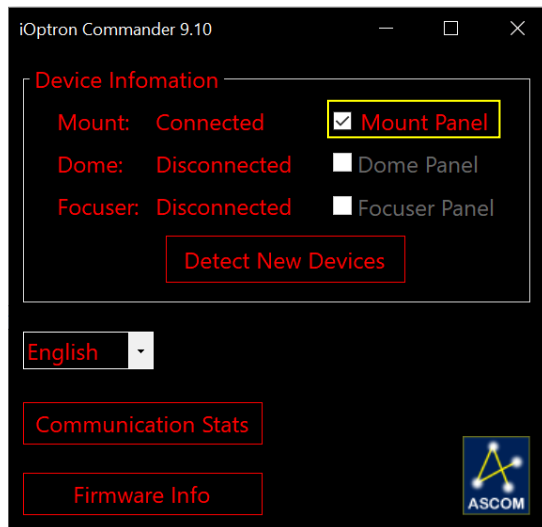

Check the mount panel to bring up the Commander.

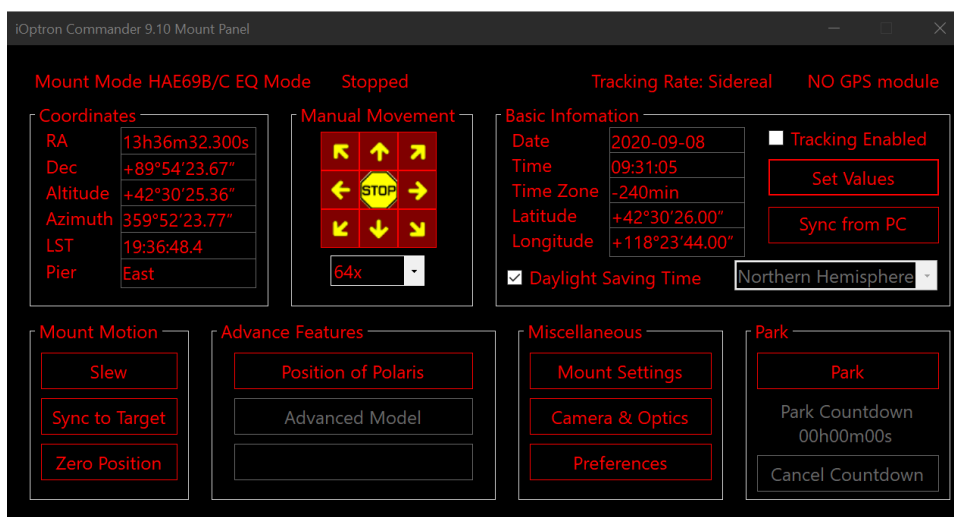

6.3.2. Set up Time and Site

Click on **Sync from PC** to set up the mount time.

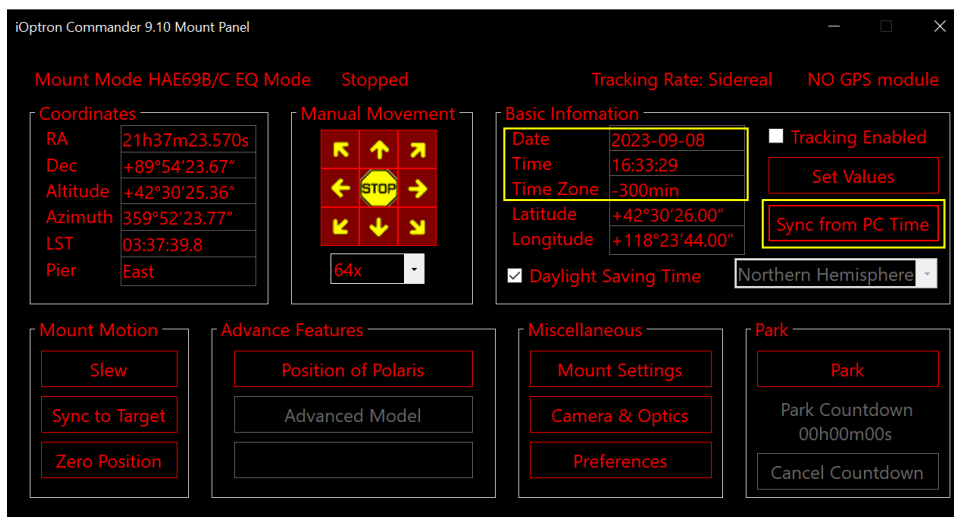

Click on **Set Values** to change GPS info, as well as Date and Time if needed.

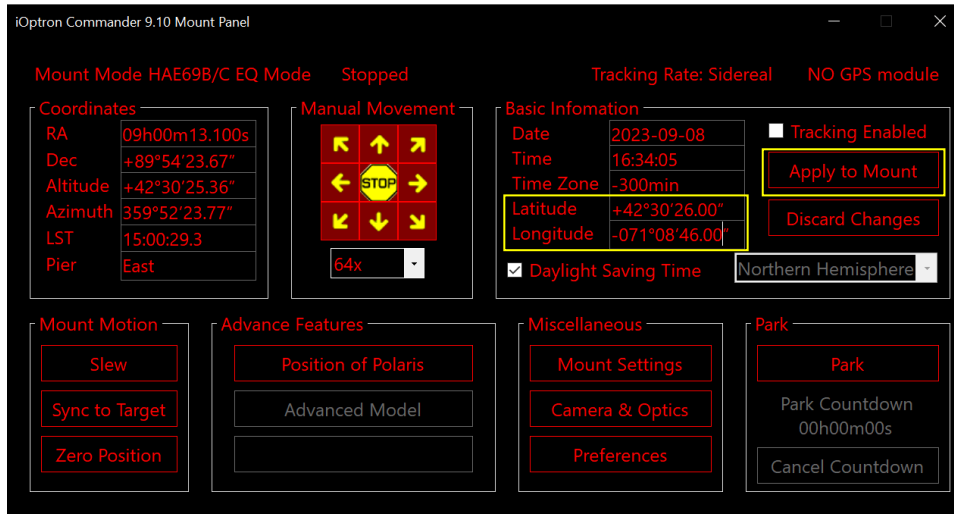
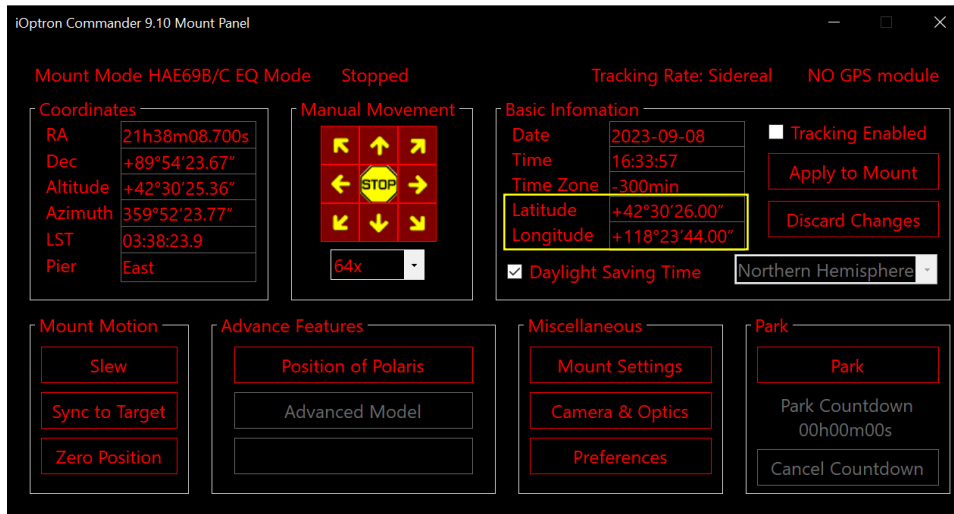

Click on **Apply to Mount** to save the changes.

6.3.3. Set Zero Position

Click on **Zero Position** to bring up **Zero Position** submenu.

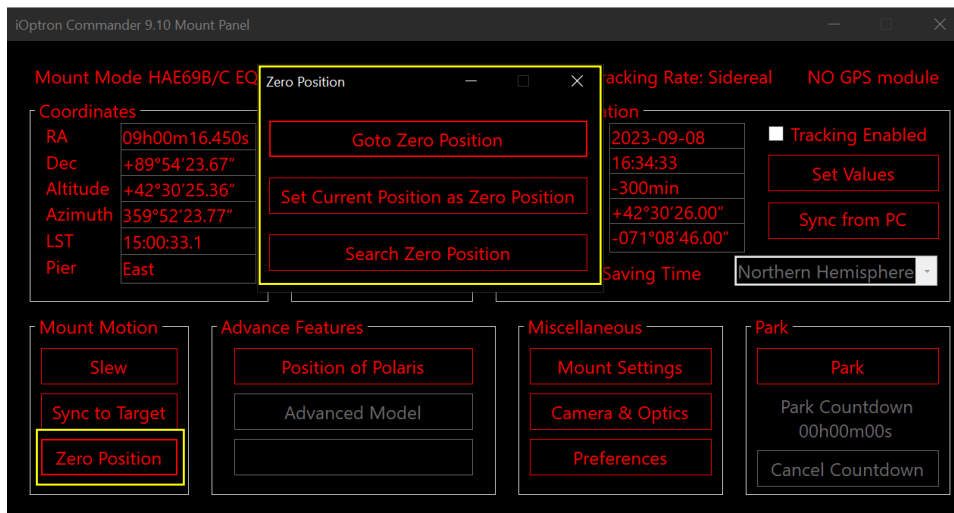

Click on **Goto Zero Position**. The mount will start searching the Zero Position. Check the mount RA and DEC position visually. Click **OK** if any adjustment is needed.

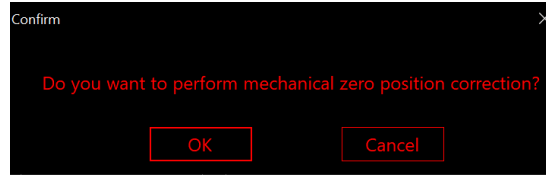

6.3.4. Move the Mount Manually

Click the speed selection pull down menu to choose a speed. Click on an arrow button to move the mount.

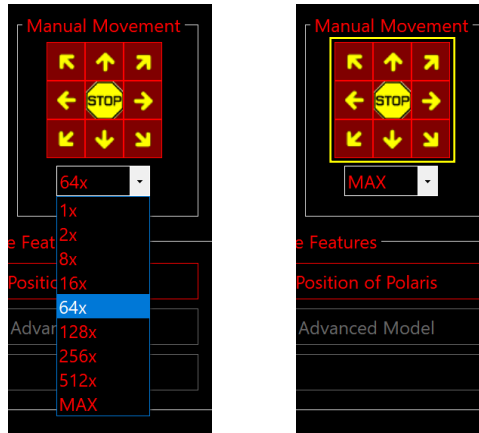

6.3.5. GoTo an Object

Click on Slew button to bring up the Slew submenu.

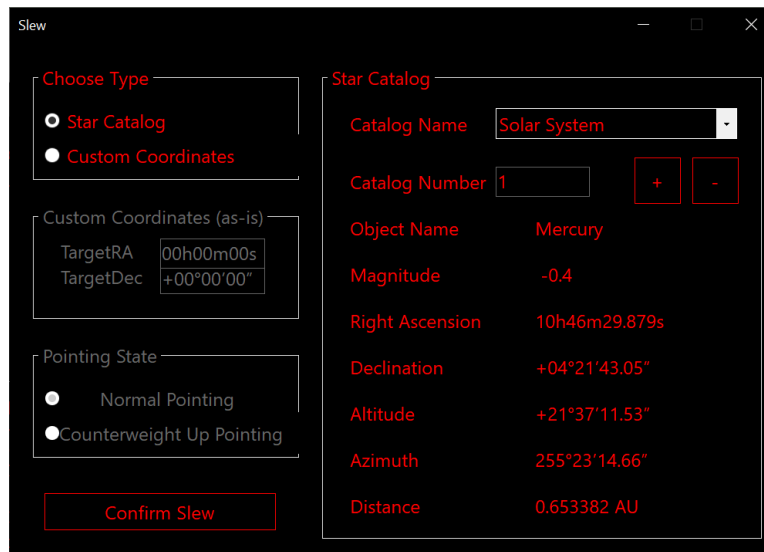
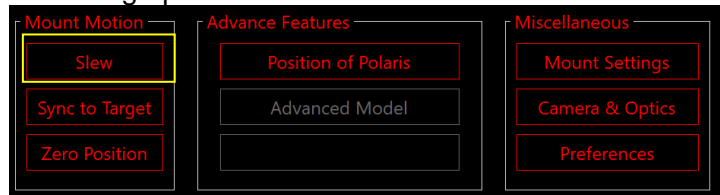

Select an object from Star catalog pull down menu and click on Confirm Slew. After the mount moving to the object, use an arrow key to center the object if it is not centered. Then click on Sync to Target.

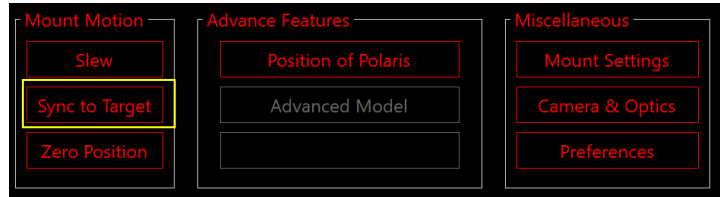

6.3.6. Other Settings

Click on Mount Settings to bring up the submenu

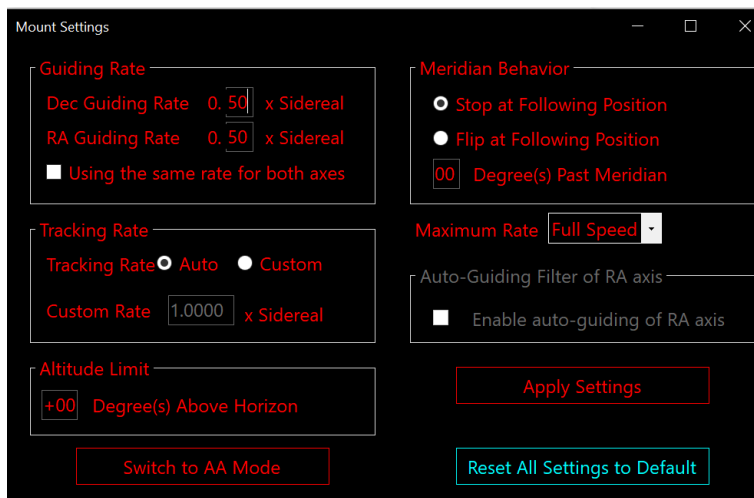
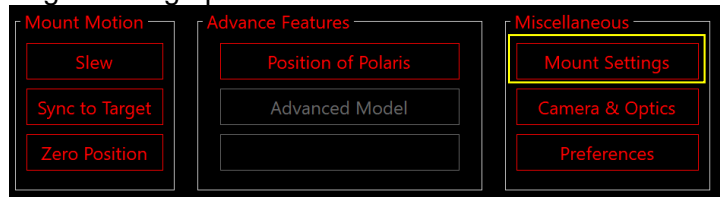

Click on the parameters you would like to change and click on Apply Settings at the end of the process to save the changes.

7. Maintenance and Servicing

7.1. Maintenance

Do not overload the mount. Do not drop the mount as this will damage the mount and / or permanently degrade GOTO performance and tracking accuracy. Use a wet cloth to clean the mount and handset. Do not use solvent.

The real time clock battery in the handset needs be replaced if it can't keep the time after powering off the mount.

If your mount is not to be used for an extended period, dismount the OTAs and counterweight(s). Remove the HC battery as well.

7.2. iOptron Customer Service

If you have any question concerning your mount, please contact the iOptron Customer Service Department. It is strongly suggested to send technical questions to support@ioptron.com for prompt response.

If the mount requires factory servicing or repairing, e-mail to iOptron Customer Service Department first to receive an RMA# before returning the mount to the factory. Please provide details as to the nature of the problem as well as your name, address, e-mail address, purchase info and daytime telephone number. We have found that most problems can be resolved by e-mails or telephone calls. So please contact iOptron first to avoid unnecessarily returning the mount for repair.

7.3. Product End of Life Disposal Instructions



This electronic product is subject to disposal and recycling regulations that vary by country and region. It is your responsibility to recycle your electronic equipment per your local environmental laws and regulations to ensure that it will be recycled in a manner that protects human health and the environment. To find out where you can drop off your waste equipment for recycling, please contact your local waste recycle/disposal service or the product representative.

7.4. Battery Replacement and Disposal Instructions



Battery Disposal- Batteries contain chemicals that, if released, may affect the environment and human health. Batteries should be collected separately for recycling, and recycled at a local hazardous material disposal location adhering to your country and local government regulations. To find out where you can drop off your waste batteries for recycling, please contact your local waste disposal service or the product representative.

Appendix A. Technical Specifications

Model	HAE69B and HAE69B EC
Mount	Strain Wave Gear Altazimuth/Equatorial Mount
RA/DEC gear system	StrainWave
RA reduction ratio	RA 800:1, DEC 800:1
Payload w/o CW*	69 lbs (31kg)
Mount weight	19 lbs (8.6 kg) with dovetail saddle
Payload/Mount weight	3.6
Payload with CW	79 lbs (36 kg)
Structure Material	All metal, CNC machined, Anodized
High precision encoder	Yes (RA, HAE69B EC only)
PEC	Realtime PEC (RPEC) (HAE69B EC only)
Period	270 second
Drive motor	Stepper motor
Latitude adjustment range	0° ~ 90°
Azimuth adjustment range	± 8°
Polar Scope	External iPolar™ electronic polar scope (optional)
Level indicator	Level bubble
Control system	GOTONOVA/Commander/iMate
Handset	Go2Nova® 8411 w/OLED display (optional)
Tracking	Automatic
Speed	1x,2x,8x,16x,64x,128x,256x,512x,MAX(4.5°/sec)
Power consumption	1A(Tracking), 1.6A(GOTO)
AC/DC adapter	AC100V~240V input, DC12V-6A output (included, indoor use only)
Power off brake	Electronic friction brake
Power-down memory	Yes
Built-in computer	Open Source Architecture iMate™ with Wi-Fi, preloaded KStarts/Ekos and iPolarServer
Ports on iMate	1X USB3.0, 2X USB2.0, 3X DC 12V outputs
Communication port	Yes (iMate and USB)
Autoguide port	Yes (ST-4 compatible)
Firmware upgrade	Yes
Dovetail saddle	Vixen/Losmandy dual saddle
Base diameter	152mm
Counterweight shaft	SS Φ20mmX200mm, 3/8-16 thread (optional)
Counterweight	10 lb (4.5kg) (optional)
Tripod	Optional
Operation temperature	-20°C ~ 40°C
Warranty	Two year limited

* Payload calculated with payload center of gravity to the RA rotation axis is 250mm.

Appendix B. Go2Nova[®] 8411 HANDSET MENU STRUCTURE

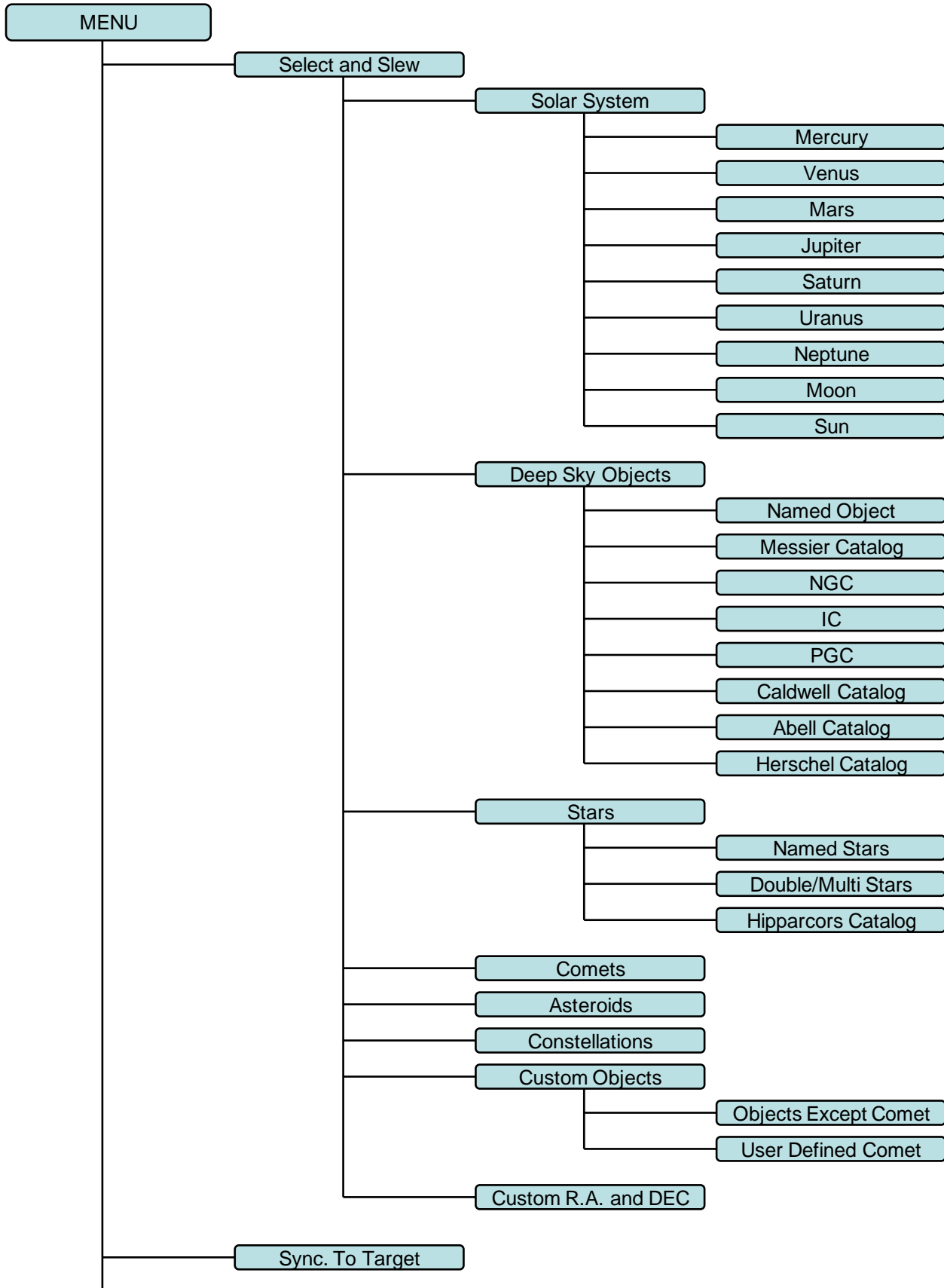

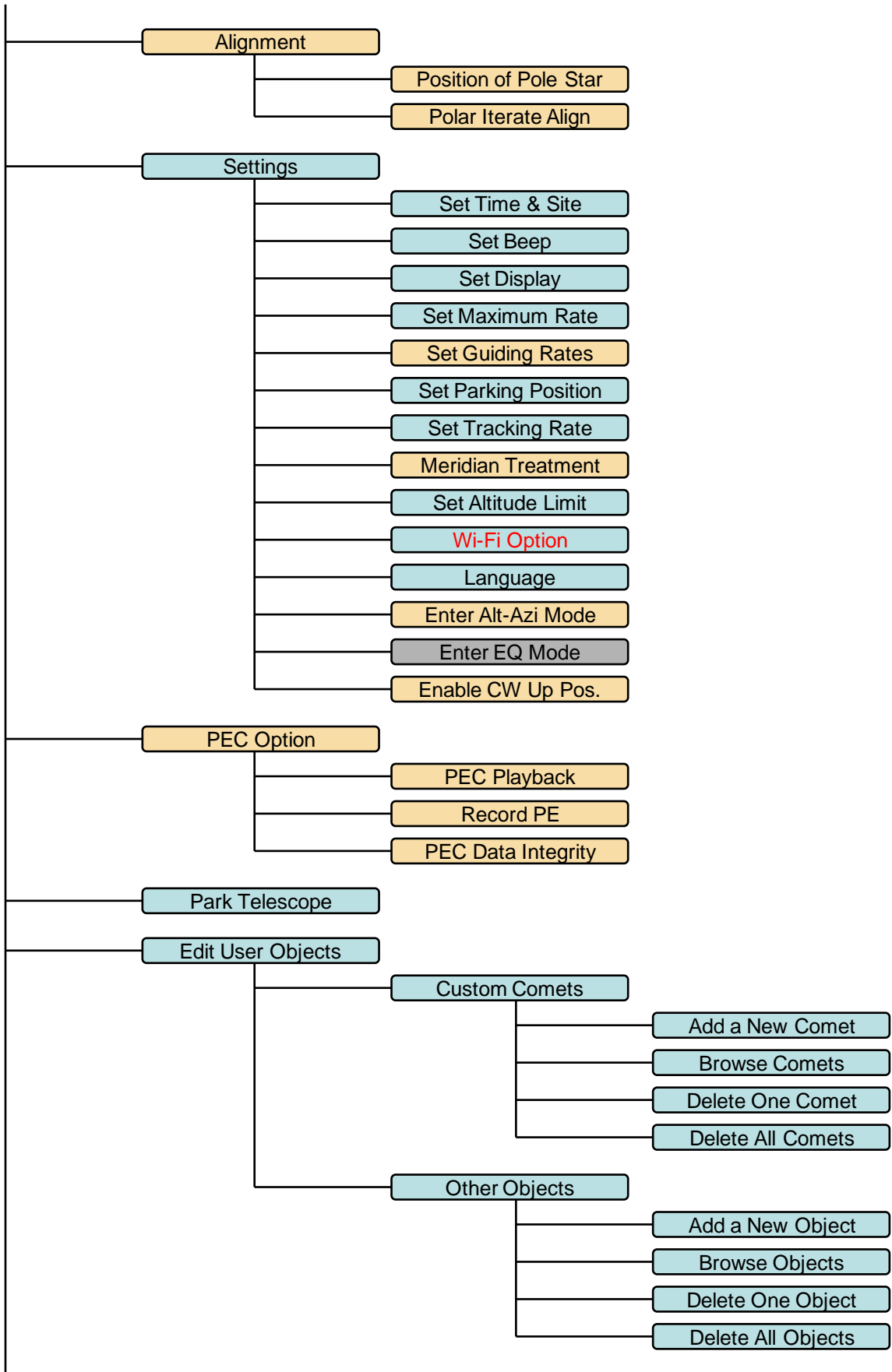

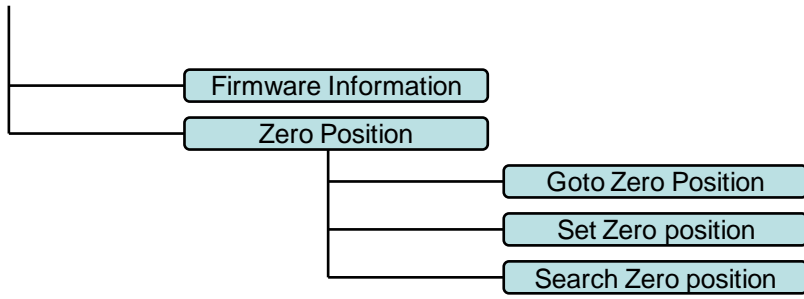

For both EQ and AA

EQ Only

AA Only

Available functions are mount specified.

Appendix C. Go2Nova[®] Star List

Named Deep Sky Object

ID No.	OBJECT	ID No.	OBJECT
1	Andromeda Galaxy	31	Hind's Variable Nebula
2	Barnards Galaxy	32	Hubble's Variable Nebula
3	Beehive Cluster	33	Integral Sign Galaxy
4	Blackeye Galaxy	34	Jewel Box Cluster
5	Blinking Planetary Nebula	35	Keyhole Nebula
6	Blue Flash Nebula	36	Lagoon Nebula
7	Blue Planetary	37	Little Gem
8	Blue Snowball Nebula	38	Little Gem Nebula
9	Box Nebula	39	Little Ghost Nebula
10	Bubble Nebula	40	North American Nebula
11	Bipolar Nebula	41	Omega Nebula
12	Butterfly Cluster	42	Orion Nebula
13	California Nebula	43	Owl Nebula
14	Cat's Eye Nebula	44	Pelican Nebula
15	Cocoon Nebula	45	Phantom Streak Nebula
16	Cone Nebula	46	Pinwheel Galaxy
17	Cork Nebula	47	Pleiades
18	Crab Nebula	48	Ring Nebula
19	Crescent Nebula	49	Ring Tail Galaxy
20	Draco Dwarf	50	Rosette Nebula
21	Duck Nebula	51	Saturn Nebula
22	Dumbbell Nebula	52	Sextans B Dwarf
23	Eagle Nebula	53	Small Magellanic Cloud
24	Eight-Burst Nebula	54	Sombrero Galaxy
25	Eskimo Nebula	55	Spindle Galaxy
26	Flaming Star Nebula	56	Tank Track Nebula
27	Ghost of Jupiter	57	Trifid Nebula
28	Great Cluster	58	Ursa Minor Dwarf
29	Helix Nebula	59	Whirlpool Galaxy
30	Hercules Galaxy Cluster	60	Wild Duck Cluster

Messier Catalog

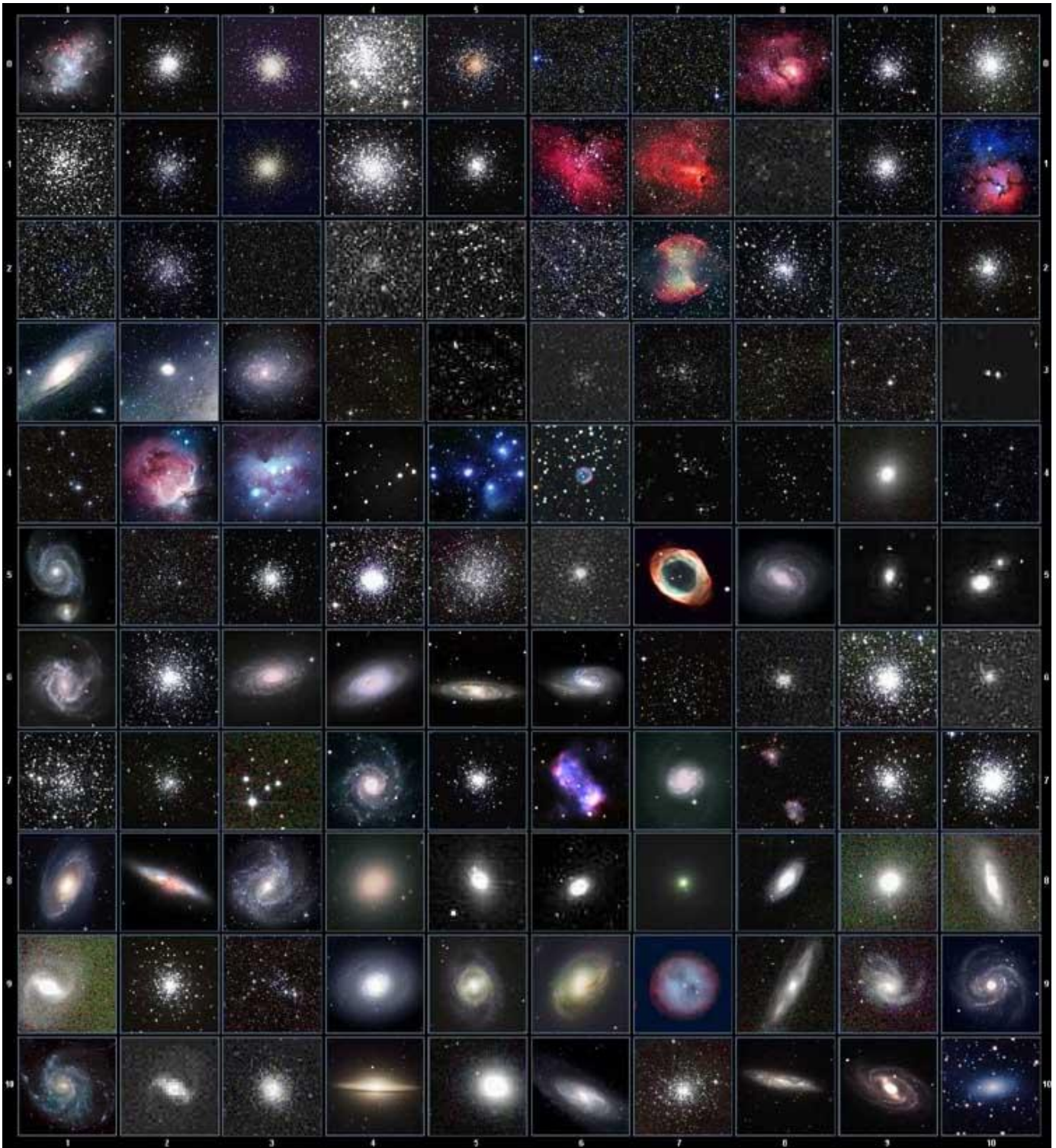

This table is licensed under the [GNU Free Documentation License](#). It uses material from the [Wikipedia article List of Messier objects](#)

Named Star

1	Acamar	50	Alrescha	99	Deneb el Okab	148	Lalande 21185
2	Achernar	51	Alshain	100	Deneb Kaitos	149	Lesath
3	Achird	52	Altair	101	Denebakrab	150	Mahasim
4	Acrab	53	Altairs	102	Denebola	151	Maia
5	Acrux A	54	Alterf	103	Dschubba	152	Marfik
6	Acrux B	55	Aludra	104	Dubhe	153	Marfikent
7	Acubens	56	Alula Australis	105	Edasich	154	Markab
8	Adhafera	57	Alula Borealis	106	El Rehla	155	Markeb
9	Adhara	58	Alya	107	Electra	156	Matar
10	Adid Australis	59	Ancha	108	Elnath	157	Mebсутa
11	Ahadi	60	Ankaa	109	Eltanin	158	Megrez
12	Al Dhanab	61	Antares	110	Enif	159	Meissa
13	Al Dhibain Prior	62	Apollyon	111	Errai	160	Mekbuda
14	Al Kab	63	Arcturus	112	Fomalhaut	161	Menkalinan
15	Al Nair	64	Arkab Prior	113	Furud	162	Menkar
16	Al Nair al Baten	65	Arneb	114	Gacrux	163	Menkent
17	Al Niyat(Sigma)	66	Ascella	115	Gatria	164	Menkib
18	Al Niyat(Tau)	67	Asellus Australis	116	Giausar	165	Merak
19	Albaldah	68	Asellus Borealis	117	Gienah Cori	166	Merope
20	Albali	69	Aspidiske	118	Gienah Cygni	167	Mesartim
21	Albireo	70	Atik	119	Girtab	168	Miaplacidus
22	Alchiba	71	Atlas	120	Gliese 1	169	Mimosa
23	Alcor	72	Atria	121	Gomeisa	170	Mintaka
24	Alcyone	73	Arior	122	Graffias(Zeta)	171	Mira
25	Aldebaran	74	Azha	123	Groombridge 1830	172	Mirach
26	Alderamin	75	Barnard's Star	124	Gruid	173	Mirfak
27	Alfirk	76	Baten Kaitos	125	Grumium	174	Mirzam
28	Algenib	77	Beid	126	Hadar	175	Mizar
29	Algenubi	78	Bellatrix	127	Hamal	176	Mu Velorum
30	Algieba	79	Beta Hydri	128	Han	177	Muhlifain
31	Algiedi Secunda	80	Betelgeuse	129	Hatsya	178	Muphrid
32	Algol	81	Betria	130	Head of Hydrus	179	Muscida
33	Algorab	82	Biham	131	Homam	180	Naos
34	Alhakim	83	Birdun	132	Iritjinga(Cen)	181	Nashira
35	Alhena	84	Canopus	133	Izar	182	Navi
36	Alioth	85	Capella	134	Kakkab Su-gub Gud-Elim	183	Nekkar
37	Alkaid	86	Caph	135	Kapteyn's Star	184	Nihal
38	Alkalurops	87	Castor A	136	Kaus Australis	185	Nunki
39	Alkes	88	Castor B	137	Kaus Borealis	186	Nusakan
40	Almaaz	89	Cebalrai	138	Kaus Media	187	Palida
41	Almach	90	Chara	139	Keid	188	Peacock
42	Alnasi	91	Chertan	140	Kekouan	189	Phact
43	Alnilam	92	Choo	141	Kitalpha	190	Phecda
44	Alnitak	93	Cor Caroli	142	Kochab	191	Pherkad
45	Alpha Muscae	94	Cursa	143	Koo She	192	Polaris
46	Alpha Tucanae	95	Dabih	144	Kornephoros	193	Pollux
47	Alphard	96	Deltotum	145	Kraz	194	Porrima
48	Alphecca	97	Deneb	146	Kurhah	195	Procyon
49	Alpheratz	98	Deneb Algedi	147	Lacaille 9352	196	Propus

197	Proxima Centauri	213	Sadalbari	229	Sulafat	245	Vindemiatrix
198	Rasalas	214	Sadalmelik	230	Syrma	246	Vrischika
199	Rasalgethi	215	Sadalsuud	231	Talitha	247	Wasat
200	Rasalhague	216	Sadr	232	Tania Australis	248	Wazn
201	Rastaban	217	Saiph	233	Tania Borealis	249	Wei
202	Regor	218	Sargas	234	Tarazed	250	Wezen
203	Regulus	219	Scheat	235	Taygeta	251	Yed Posterior
204	Rigel	220	Schedar	236	Tejat Posterior	252	Yed Prior
205	Rigel Kentaurus A	221	Seginus	237	Thuban	253	Zaniah
206	Rigel Kentaurus B	222	Shaula	238	Thusia	254	Zaurak
207	Ruchbah	223	Sheliak	239	Tien Kwan	255	Zavijava
208	Rukbat	224	Sheratan	240	Turais	256	Zeta Persei
209	Rukh	225	Sirius	241	Unukalhai	257	Zosma
210	Rutilicus	226	Skat	242	Vasat-ul-cemre	258	Zubenelgenubi
211	Sabik	227	Spica	243	Vathorz Posterior	259	Zubeneschamali
212	Sadachbia	228	Suhail	244	Vega		

Modern Constellations

No.	Constellation	Abbreviation
1	Andromeda	And
2	Antlia	Ant
3	Apus	Aps
4	Aquarius	Aqr
5	Aquila	Aql
6	Ara	Ara
7	Aries	Ari
8	Auriga	Aur
9	Boötes	Boo
10	Caelum	Cae
11	Camelopardalis	Cam
12	Cancer	Cnc
13	Canes Venatici	CVn
14	Canis Major	CMA
15	Canis Minor	CMi
16	Capricornus	Cap
17	Carina	Car
18	Cassiopeia	Cas
19	Centaurus	Cen
20	Cepheus	Cep
21	Cetus	Cet
22	Chamaeleon	Cha
23	Circinus	Cir
24	Columba	Col
25	Coma Berenices	Com
26	Corona Australis	CrA
27	Corona Borealis	CrB
28	Corvus	Crv
29	Crater	Crt
30	Crux	Cru
31	Cygnus	Cyg
32	Delphinus	Del
33	Dorado	Dor
34	Draco	Dra
35	Equuleus	Equ
36	Eridanus	Eri
37	Fornax	For
38	Gemini	Gem
39	Grus	Gru
40	Hercules	Her
41	Horologium	Hor
42	Hydra	Hya
43	Hydrus	Hyi
44	Indus	Ind

No.	Constellation	Abbreviation
45	Lacerta	Lac
46	Leo	Leo
47	Leo Minor	LMi
48	Lepus	Lep
49	Libra	Lib
50	Lupus	Lup
51	Lynx	Lyn
52	Lyra	Lyr
53	Mensa	Men
54	Microscopium	Mic
55	Monoceros	Mon
56	Musca	Mus
57	Norma	Nor
58	Octans	Oct
59	Ophiuchus	Oph
60	Orion	Ori
61	Pavo	Pav
62	Pegasus	Peg
63	Perseus	Per
64	Phoenix	Phe
65	Pictor	Pic
66	Pisces	Psc
67	Piscis Austrinus	PsA
68	Puppis	Pup
69	Pyxis	Pyx
70	Reticulum	Ret
71	Sagitta	Sge
72	Sagittarius	Sgr
73	Scorpius	Sco
74	Sculptor	Scl
75	Scutum	Sct
76	Serpens	Ser
77	Sextans	Sex
78	Taurus	Tau
79	Telescopium	Tel
80	Triangulum	Tri
81	Triangulum Australe	TrA
82	Tucana	Tuc
83	Ursa Major	UMa
84	Ursa Minor	UMi
85	Vela	Vel
86	Virgo	Vir
87	Volans	Vol
88	Vulpecula	Vul

Double/Multi Stars

No.	HC Item		Constellation	Name	HIP	WDS	SAO
1	Rigel Kentaurus A	Alpha Centauri	Centaurus		71683	14396-6050	252838
2	Rigel	Beta Orionis	Orion		24436	05145-0812	131907
3	Gacrux	Gamma Crucis	Crux		61084	12312-5707	240019
4	Sargas	Theta Scorpii	Scorpius		86228	17373-4300	228201
5	Castor A	Alpha Geminorum	Gemini		36850	07346+3153	60198
6	Mizar	Zeta Ursae Majoris	Ursa Major		65378	13239+5456	28737
7	Almach	Gamma Andromedae	Andromeda		9640	02039+4220	37735
8	Algieba	Gamma Leonis	Leo		50583	10200+1950	81298
9	Aludra	Eta Canis Majoris	Canis Major		35904	07241-2918	173651
10	Iritjinga (Cen)	Gamma Centauri	Centaurus	Muhlifain	61932	12415-4858	223603
11	Zubenelgenubi	Alpha Librae	Libra		72603	14509-1603	158836
12	Alcyone	Eta Tauri	Taurus		17702	03475+2406	76199
13	Cor Caroli	Alpha Canum Venaticorum	Canes Venatici		63125	12560+3819	63257
14	Acamar	Theta Eridani	Eridanus		13847	02583-4018	216113
15	Adhafera	Zeta Leonis	Leo		50335	10167+2325	81265
16	Rasalgethi	Alpha Herculis	Hercules		84345	17146+1423	102680
17	Meissa	Lambda Orionis	Orion		26207	05351+0956	112921
18	Graffias	Beta1 Scorpii	Scorpius		78820	16054-1948	159682
19	Alya	Theta Serpentis	Serpens		92946	18562+0412	124068
20	HIP 48002	Upsilon Carinae	Carina	Vathorz Prior		09471-6504	250695
21	HIP 95947	Beta1 Cygni	Cygnus	Albireo		19307+2758	87301
22	HIP 20894	Theta2 Tauri	Taurus			04287+1552	93957
23	HIP 74395	Zeta Lupi	Lupus			15123-5206	242304
24	HIP 27072	Gamma Leporis	Lupus			05445-2227	170759
25	HIP 26549	Sigma Orionis	Orion			05387-0236	132406
26	HIP 85667	HD 158614	Ophiuchus			17304-0104	141702
27	HIP 74376	Kappa1 Lupi	Lupus			15119-4844	225525
28	HIP 34481	Gamma2 Volantis	Carina			07087-7030	256374
29	HIP 53253	Upsilon Carinae	Carina			10535-5851	238574
30	HIP 99675	Omicron1 Cygni	Cygnus	31 Cyg		20136+4644	49337
31	HIP 63003	Mu1 Crucis	Crux			12546-5711	240366
32	HIP 43103	Iota Cancri	Cancer	48 Cnc		08467+2846	80416
33	HIP 110991	Delta Cephei	Cepheus	27 Cep		22292+5825	34508
34	HIP 20635	Kappa1 Tauri	Taurus	65 Tau		04254+2218	76601
35	HIP 88601	70 Ophiuchi	Orion			18055+0230	123107
36	HIP 2484	Beta1 Tucanae	Horologium			00315-6257	248201
37	HIP 91971	Zeta1 Lyrae	Cygnus	6 Lyr		18448+3736	67321
38	HIP 79374	Nu Scorpii	Scorpius	Jabbah		16120-1928	159764
39	HIP 102532	Gamma2 Delphini	Pegasus	12 Del		20467+1607	106476
40	HIP 52154	Xi Velorum	Vela			10393-5536	238309
41	HIP 37229	HD 61555	Canis Major			07388-2648	174198
42	HIP 30419	Epsilon Monocerotis	Orion	8 Mon		06238+0436	113810
43	HIP 108917	Xi Cephei	Cepheus	Al kurhah		22038+6438	19827
44	HIP 53417	54 Leonis	Leo			10556+2445	81584
45	HIP 65271	J Centauri	Centaurus			13226-6059	252284
46	HIP 67669	3 Centauri	Centaurus			13518-3300	204916
47	HIP 105319	Theta Indi	Indus			21199-5327	246965
48	HIP 80582	Epsilon Normae	Norma			16272-4733	226773
49	HIP 8832	Gamma Arietis	Aries			01535+1918	92680
50	HIP 69483	Kappa Boötis	Boötes	Asellus Tertius		14135+5147	29045
51	HIP 92946	Theta Serpentis	Serpens			18562+0412	124068
52	HIP 86614	Psi1 Draconis	Draco	31 Draconis		17419+7209	8890

No.	HC Item		Constellation	Name	HIP	WDS	SAO
53	HIP 95771	Alpha Vulpeculae	Vulpecula	Anser		19287+2440	87261
54	HIP 30867	Beta Monocerotis	Monoceros			06288-0702	133316
55	HIP 35363	NV Puppis	Puppis			07183-3644	197824
56	HIP 94761	Gliese 752	Aquila	Wolf 1055, Ross 652		19169+0510	
57	HIP 21683	Sigma2 Tauri	Taurus			04393+1555	94054
58	HIP 8497	Chi Ceti	Cetus	53 Cet		01496-1041	148036
59	HIP 26199	HD 36960	Orion			05350-0600	132301
60	HIP 104521	Gamma Equulei	Equuleus	5 Equ		21103+1008	126593
61	HIP 116389	Iota Phoenicis	Phoenix			23351-4237	231675
62	HIP 17797	HD 24071	Eridanus			03486-3737	194550
63	HIP 21036	83 Tauri	Taurus			04306+1343	93979
64	HIP 107310	Mu1 Cygni	Cygnus	78 Cyg		21441+2845	89940
65	HIP 72659	Xi Boötis	Boötes	37 Boo		14514+1906	101250
66	HIP 21029	HD 28527	Taurus			04306+1612	93975
67	HIP 42726	HY Velorum	Vela			08424-5307	236205
68	HIP 18255	32 Eridani	Eridanus			03543-0257	130806
69	HIP 9153	Lambda Arietis	Aries			01580+2336	75051
70	HIP 88267	95 Herculis	Hercules			18015+2136	85648
71	HIP 85829	Nu2 Draconis	Draco	25 Dra		17322+5511	30450
72	HIP 43937	V376 Carinae	Carina	b1 Carinae		08570-5914	236436
73	HIP 71762	Pi2 Boötis	Boötes	29 Boo		14407+1625	101139
74	HIP 80047	Delta1 Apodis	Apus			16203-7842	257380
75	HIP 58484	Epsilon Chamaeleontis	Chamaeleon			11596-7813	256894
76	HIP 25142	23 Orionis	Orion			05228+0333	112697
77	HIP 54204	Chi1 Hydrae	Hydra			11053-2718	179514
78	HIP 76669	Zeta Coronae Borealis	Corona Borealis	7 CrB		15394+3638	64833
79	HIP 99770	b3 Cygni	Cygnus	29 Cyg		20145+3648	69678
80	HIP 101027	Rho Capricorni	Capricornus	11 Cap		20289-1749	163614
81	HIP 74911	Nu Lupi	Lupus			15185-4753	225638
82	HIP 35210	HD 56577	Canis Major			07166-2319	173349
83	HIP 26235	Theta2 Orionis	Orion	43 Ori		05354-0525	132321
84	HIP 40321	OS Puppis	Puppis			08140-3619	198969
85	HIP 70327	HD 126129	Boötes			14234+0827	120426
86	HIP 26221	Theta1 Orionis	Orion	Trapezium		05353-0523	132314
87	HIP 80473	Rho Ophiuchi	Ophiuchus	5 Oph		16256-2327	184381
88	HIP 78105	Xi1 Lupi	Lupus			15569-3358	207144
89	HIP 79043	Kappa Herculis	Hercules	7 Her		16081+1703	101951
90	HIP 61418	24 Comae Berenices	Coma Berenices			12351+1823	100160
91	HIP 91919	Epsilon Lyrae	Lyra	4 Lyr		18443+3940	67309
92	HIP 41639	HD 72127	Vela			08295-4443	219996
93	HIP 104214	61 Cygni	Cygnus			21069+3845	70919
94	HIP 23734	11 Camelopardalis	Camelopardalis			05061+5858	25001
95	HIP 60189	Zeta Corvi	Corvus	5 Crv		12206-2213	180700
96	HIP 66821	Q Centauri	Centaurus			13417-5434	241076
97	HIP 14043	HD 18537	Perseus			03009+5221	23763
98	HIP 5737	Zeta Piscium	Pisces	86 Psc		01137+0735	109739
99	HIP 84626	Omicron Ophiuchi	Ophiuchus	39 Oph		17180-2417	185238
100	HIP 60904	17 Comae Berenices	Coma Berenices			12289+2555	82330
101	HIP 58684	67 Ursae Majoris	Ursa Major			12021+4303	44002
102	HIP 5131	Psi1 Piscium	Pisces	74 Psc		01057+2128	74482
103	HIP 115126	94 Aquarii	Aquarius			23191-1328	165625
104	HIP 62572	HD 112028	Camelopardalis			12492+8325	2102

No.	HC Item		Constellation	Name	HIP	WDS	SAO
105	HIP 40167	Zeta1 Cancri	Cancer	Tegmen		08122+1739	97645
106	HIP 40817	Kappa Volantis	Volans			08198-7131	256497
107	HIP 81292	17 Draconis	Draco			16362+5255	30013
108	HIP 80197	Nu1 Coronae Borealis	Corona Borealis			16224+3348	65257
109	HIP 88060	HD 163756	Sagittarius			17591-3015	209553
110	HIP 42637	Eta Chamaeleontis	Chamaeleon			08413-7858	256543
111	HIP 21039	81 Tauri	Taurus			04306+1542	93978
112	HIP 100965	75 Draconis	Draco			20282+8125	3408
113	HIP 25768	HD 36553	Pictor			05302-4705	217368
114	HIP 93717	15 Aquilae	Aquila			19050-0402	142996
115	HIP 79980	HD 148836	Scorpius			16195-3054	207558
116	HIP 12086	15 Trianguli	Triangulum			02358+3441	55687
117	HIP 90968	Kappa2 Coronae Australe	Corona Australis			18334-3844	210295
118	HIP 22531	Iota Pictoris	Pictor			04509-5328	233709
119	HIP 34065	HD 53705	Puppis			07040-4337	218421
120	HIP 79607	Sigma Coronae Borealis	Corona Borealis			16147+3352	65165
121	HIP 109786	41 Aquarii	Aquarius			22143-2104	190986
122	HIP 56280	17 Crateris	Hydra			11323-2916	179968
123	HIP 51561	HD 91355	Vela			10320-4504	222126
124	HIP 107930	HD 208095	Cepheus			21520+5548	33819
125	HIP 97966	57 Aquilae	Aquila			19546-0814	143898
126	HIP 117218	107 Aquarii	Aquarius.			23460-1841	165867
127	HIP 82676	HD 152234	Scorpius			16540-4148	227377
128	HIP 111546	8 Lacertae	Lacerta			22359+3938	72509
129	HIP 29151	HD 42111	Orion			06090+0230	113507
130	HIP 107253	79 Cygni	Cygnus			21434+3817	71643
131	HIP 88136	41 Draconis	Draco			18002+8000	8996
132	HIP 81702	HD 150136	Ara			16413-4846	227049
133	HIP 97423	HD 186984	Sagittarius			19480-1342	162998
134	HIP 30444	HD 45145	Columba			06240-3642	196774
135	HIP 66400	HD 118349	Hydra			13368-2630	181790
136	HIP 17579	21 Tauri	Taurus	Asterope		03459+2433	76159
137	HIP 35785	19 Lyncis	Lynx			07229+5517	26312
138	HIP 81641	37 Herculis	Hercules			16406+0413	121776
139	HIP 7751	p Eridani	Eridanus			01398-5612	232490
140	HIP 21148	1 Camelopardalis	Camelopardalis			04320+5355	24672
141	HIP 9021	56 Andromedae	Andromeda			01562+3715	55107
142	HIP 97816	HD 187420	Telescopium			19526-5458	246311
143	HIP 88818	100 Herculis	Hercules			18078+2606	85753
144	HIP 36817	HD 60584	Puppis			07343-2328	174019
145	HIP 25695	HD 35943	Taurus			05293+2509	77200
146	HIP 98819	15 Sagittae	Sagitta			20041+1704	105635
147	HIP 61910	VV Corvi	Corvus			12413-1301	157447
148	HIP 111643	Sigma2 Gruis	Grus			22370-4035	231217
149	HIP 80399	HD 147722	Scorpius			16247-2942	184368
150	HIP 83478	HD 154228	Hercules			17037+1336	102564
151	HIP 101123	Omicron Capricorni	Capricornus			20299-1835	163626
152	HIP 28271	59 Orionis	Orion			05584+0150	113315
153	HIP 64246	17 Canum Venaticorum	Canes Venatici			13101+3830	63380
154	HIP 96895	16 Cygni	Cygnus			19418+5032	31898
155	HIP 35564	HD 57852	Carina			07204-5219	235110
156	HIP 37843	2 Puppis	Puppis			07455-1441	153363

No.	HC Item		Constellation	Name	HIP	WDS	SAO
157	HIP 28790	HD 41742	Puppis			06047-4505	217706
158	HIP 4675	HD 5788	Andromeda			01001+4443	36832
159	HIP 31676	8 Lyncis	Lynx			06377+6129	13897
160	HIP 10176	59 Andromedae	Andromeda			02109+3902	55330
161	HIP 25950	HD 36408	Taurus			05322+1703	94630
162	HIP 117931	AL Sculptoris	Sculptor			23553-3155	214860
163	HIP 81914	HD 150591	Scorpius			16439-4107	227123
164	HIP 21242	m Persei	Perseus			04334+4304	39604
165	HIP 86831	61 Ophiuchi	Ophiuchus			17446+0235	122690
166	HIP 115272	HD 220003	Grus			23208-5018	247838
167	HIP 46657	Zeta1 Antliae	Antlia			09308-3153	200444
168	HIP 41404	Phi2 Cancri	Cancer			08268+2656	80188
169	HIP 29388	41 Aurigae	Auriga			06116+4843	40925
170	HIP 49321	HD 87344	Hydra			10040-1806	155704
171	HIP 84054	63 Herculis	Hercules			17111+2414	84896
172	HIP 39035	HD 66005	Puppis			07592-4959	219249
173	HIP 25303	Theta Pictoris	Pictor			05248-5219	233965
174	HIP 52520	HD 93344	Carina			10443-7052	256750
175	HIP 95398	2 Sagittae	Sagitta			19244+1656	104797
176	UCAC4 277-135548						
177	HIP 32609	HD 48766	Lynx			06482+5542	25963
178	HIP 101765	48 Cygni	Cygnus			20375+3134	70287
179	HIP 24825	YZ Leporis	Lepus			05193-1831	150335
180	HIP 31158	21 Geminorum	Gemini			06323+1747	95795
181	HIP 3885	65 Piscium	Pisces			00499+2743	74295
182	HIP 93371	HD 176270	Australis			19011-3704	210816
183	HIP 36345	HD 59499	Puppis			07289-3151	198038
184	HIP 108364	HD 208947	Cepheus			21572+6609	19760
185	HIP 50939	HD 90125	Sextans			10242+0222	118278
186	HIP 76603	HD 139461	Libra			15387-0847	140672
187	HIP 32269	HD 49219	Carina			06442-5442	234683
188	HIP 42516	39 Cancri	Cancer			08401+2000	80333
189	HIP 62807	32 Comae Berenices	Coma Berenices			12522+1704	100309
190	UCAC4 226-128246						
191	HIP 94913	24 Aquilae	Aquila			19188+0020	124492
192	HIP 94336	HD 179958	Cygnus			19121+4951	48193
193	HIP 107299	HD 206429	Indus			21440-5720	247151
194	HIP 59984	HD 106976	Virgo			12182-0357	138704
195	HIP 16411	HD 21743	Taurus			03313+2734	75970
196	HIP 23287	HD 32040	Orion			05006+0337	112305
197	HIP 105637	HD 203857	Cygnus			21238+3721	71280
198	HIP 108925	HD 209744	Cepheus			22039+5949	34016
199	HIP 103814	HD 200011	Microscopium			21022-4300	230492
200	HIP 58112	65 Ursae Majoris	Ursa Major			11551+4629	43945
201	HIP 109354	V402 Lacertae	Lacerta			22093+4451	51698
202	HIP 43822	17 Hydrae	Hydra			08555-0758	136409
203	HIP 21986	55 Eridani	Eridanus			04436-0848	131442
204	HIP 17470	HD 23245	Taurus			03446+2754	76122
205	HIP 35960	V368 Puppis	Puppis			07248-3717	197974
206	HIP 42936	HD75086	Carina			08451-5843	236241
207	HIP 19272	SZ Camelopardalis	Camelopardalis			04078+6220	13031
208	HIP 76143	HD 138488	Libra			15332-2429	183565

Appendix D. Firmware Upgrade

The firmware of the HAE69B mount and 8411 handset firmware can be upgraded by the customer. The mount firmware upgrade is via the USB-C port on mount base and 8411 firmware is via the USB-C port on the handset.

Please check iOptron's website, www.iOptron.com, under the product page or Support Directory, for detailed information.

Appendix E. Computer Control an HAE Mount

The HAE69B has an onboard computer that can be controlled by a SmartPhone, a Tablet or a computer.

To use your own computer or a Pi based astronomical control box, please use the USB2.0 port (USB-C connector) on the base.

iOptron Commander/ASCOM driver (for Windows) is located on iOptron website, under the product page or Support Directory.

IOPTRON TWO YEAR TELESCOPE, MOUNT, AND CONTROLLER WARRANTY

A. iOptron warrants your telescope, mount, or controller to be free from defects in materials and workmanship for two years. iOptron will repair or replace such product or part which, upon inspection by iOptron, is found to be defective in materials or workmanship. As a condition to the obligation of iOptron to repair or replace such product, the product must be returned to iOptron together with proof-of-purchase satisfactory to iOptron.

B. The Proper Return Merchant Authorization Number must be obtained from iOptron in advance of return. Contact iOptron at support@ioptron.com to receive the RMA number to be displayed on the outside of your shipping container.

All returns must be accompanied by a written statement stating the name, address, and daytime telephone number of the owner, together with a brief description of any claimed defects. Parts or product for which replacement is made shall become the property of iOptron.

The customer shall be responsible for all costs of transportation and insurance, both to and from the factory of iOptron, and shall be required to prepay such costs.

iOptron shall use reasonable efforts to repair or replace any telescope, mount, or controller covered by this warranty within thirty days of receipt. In the event repair or replacement shall require more than thirty days, iOptron shall notify the customer accordingly. iOptron reserves the right to replace any product which has been discontinued from its product line with a new product of comparable value and function.

This warranty shall be void and of no force or effect in the event a covered product has been modified in design or function, or subjected to abuse, misuse, mishandling or unauthorized repair. Further, product malfunction or deterioration due to normal wear is not covered by this warranty.

IOPTRON DISCLAIMS ANY WARRANTIES, EXPRESS OR IMPLIED, WHETHER OF MERCHANTABILITY OF FITNESS FOR A PARTICULAR USE, EXCEPT AS EXPRESSLY SET FORTH HERE. THE SOLE OBLIGATION OF IOPTRON UNDER THIS LIMITED WARRANTY SHALL BE TO REPAIR OR REPLACE THE COVERED PRODUCT, IN ACCORDANCE WITH THE TERMS SET FORTH HERE. IOPTRON EXPRESSLY DISCLAIMS ANY LOST PROFITS, GENERAL, SPECIAL, INDIRECT OR CONSEQUENTIAL DAMAGES WHICH MAY RESULT FROM BREACH OF ANY WARRANTY, OR ARISING OUT OF THE USE OR INABILITY TO USE ANY IOPTRON PRODUCT. ANY WARRANTIES WHICH ARE IMPLIED AND WHICH CANNOT BE DISCLAIMED SHALL BE LIMITED IN DURATION TO A TERM OF TWO YEARS FROM THE DATE OF ORIGINAL RETAIL PURCHASE.

Some states do not allow the exclusion or limitation of incidental or consequential damages or limitation on how long an implied warranty lasts, so the above limitations and exclusions may not apply to you.

This warranty gives you specific legal rights, and you may also have other rights which vary from state to state.

iOptron reserves the right to modify or discontinue, without prior notice to you, any model or style telescope.

If warranty problems arise, or if you need assistance in using your telescope, mount, or controller contact:

iOptron Corporation
Customer Service Department
6E Gill Street
Woburn, MA 01801
www.ioptron.com
support@ioptron.com

NOTE: This warranty is valid to U.S.A. and Canadian customers who have purchased this product from an authorized iOptron dealer in the U.S.A. or Canada or directly from iOptron. Warranty outside the U.S.A. and Canada is valid only to customers who purchased from an iOptron Distributor or Authorized iOptron Dealer in the specific country. Please contact them for any warranty.