

WARRANTY REGISTRATION FORM

We sincerely thank you for your purchase and wish you years of pleasure using it!

Tele Vue Warranty Summary

Eyepieces, Barlows, Powermates, & Paracorr have a "Lifetime Limited" warranty, telescopes & accessories are warranted for 5 years. Electronic parts are warranted for 1 year. Warranty is against defects in material or workmanship. No other warranty is expressed or implied. No returns without prior authorization.

Lifetime Limited Warranty details online: <http://bit.ly/TVOPTLIFE>

5-Year/1-Year Warranty details online: <http://bit.ly/TVOPTLIMITED>

Subscribe to our Blog for the latest Tele Vue news: <https://bit.ly/TeleVueBlog>

Keep For Your Records

Dealer: _____ City/State/Country: _____

Date (day/month/yr): ____/____/____ **10.0 Ethos (ETH-10.0)**

Tele Vue®
32 Elkay Drive
Chester, NY 10918-3001
U.S.A.

Please fill out, cut out, and mail form below within 2-weeks of product purchase. **Please include copy of sales receipt that has your name, the dealer name, and product name.**

Cut out mailing address at left, tape to envelope, insert form & sales receipt in envelope and apply sufficient postage to envelope.

10.0 Ethos (ETH-10.0)

Name Last _____ First _____

Street Address _____

City _____ State/Province _____

Postal Code _____ Country _____

Email*: _____

Phone: _____

Astro Club: _____

How did you learn about this product?

- Dealer Friend Tele Vue Blog
 CloudyNights.com TeleVue.com
 Social Media/Magazine/Other(s):

What made you decide to buy this and your comments after using the product?

Purchase Information

Dealer: _____

City/State/Country: _____

Date (day/month/yr): ____/____/____

Ethos 6, 8, 10, & 13mm 100° Eyepieces

Thank you for purchasing this Ethos eyepiece. We wish you years of exciting viewing with ETHOS, and we welcome comments on your personal experiences.

ETHOS 100° apparent field models fits both 2" and 1 1/4" focusers or diagonals.

Note: the in-travel may prevent focusing in some refractors when using the Tele Vue 60° Everbrite diagonal, which has an unusually long optical path.

Since it is designed as a 1 1/4" eyepiece, there is NO optical benefit by using a 2" holder. The 2" barrel is included just for convenience, but it is also threaded to accept our EBX-2120 2" extension tube, which allows the use of 48mm filters.

WARNING

Do not unscrew the chrome barrel on the 10-, 13-, or 17mm. The lenses will fall out, voiding the warranty.

Focus Position with 10- & 13mm

These are parfocal with each other. Typically, in 2" mode, you will focus "out" about 3/8" further than a 26mm Nagler Type 5, and in a 1 1/4" mode you'll focus "in" about 1/2" inch further than a 25mm Plössl.

Focus Position with 6- & 8mm

These are parfocal with each other. Typically, in 2" mode, you will focus "out" about 3/4" further than a 26mm Nagler Type 5, and in 1 1/4" mode, if you use Tele Vue's "high-hat" 2"-1 1/4" adapter, it will be parfocal with Tele Vue's Plössls, Type 6 Naglers, Nagler Zooms, and 1 1/4" Panoptics.

For 1 1/4" holders

- 1) Back off the lock screw in the 2" barrel section of the eyepiece so it can be fully inserted into the holder.
- 2) If the holder has a lock screw, rotate the eyepiece so that the screw slips into the slot in the 2" section of the eyepiece barrel. Your holder lock screw clamps to the 1 1/4" barrel of the eyepiece, while the eyepiece lock screw clamps (if desired) to the outside of your holder for maximum safety.
- 3) If your holder doesn't have a lock screw, be sure to clamp the eyepiece lock screw onto the outside of the holder. Please note that this eyepiece is heavy, and can fall out of holders with a "slip fit" unless the lock screw is used!

For 2" holders

- 1) Remove the eyepiece lock screw (Don't lose it!)
- 2) Use the lock screw on your 2" holder, being careful not to let it slip into the slot in the 2" barrel of the eyepiece.
- 3) The eyepiece will not "bottom" on Tele Vue 2" diagonals. Be careful if using diagonals by other manufacturers.

Paracorr Coma Corrector

For Newtonians/Dobsonians, we recommend our Paracorr coma corrector to eliminate the mirror coma in f/5.5 or faster scopes. This permits the same kind of full field sharpness routinely seen in Tele Vue's NP-Series refractors. See your Paracorr instruction sheet for proper setting.

Note: when using a 1 1/4" filter in ETHOS, be careful not to accidentally set the Paracorr's tunable top to its lowest setting, as the bottom of the filter might contact the Paracorr's upper lens. It's best to thread a 2" filter onto the front of the Paracorr, or add our EBX-2120 2" extension tube to the 2" barrel of ETHOS, for general use.

Barlows & Powermate

For higher magnifications with a 100° field, use Tele Vue Barlows and Powermates. When using ETHOS in 2" Powermates, use its 2" barrel.

Note: As with the Paracorr, do not use a 1 1/4" filter when using a 2X Powermate, as it will contact the upper lens in the 2X Powermate. Again, the best solution is to use 2" filters in front of the Powermate.



32 Elkay Dr., Chester, New York 10918 (845) 469-4551. televue.com



@televueoptics

V08/15/20

Ethos / Ethos-SX Eyepiece Specifications

Dimensions, Weights, & Compatibility

Prod Code	Focal Length (mm)	Barrel (in)	App. Field (°)	Eye Relief (mm)	Field Stop (mm)	Eyepiece Dimensions (in.)*						Weight (lb / oz)	Use with Bino Vue?
						A	B	C	D	E	F		
ETH-21.0	21	2"	100	15	36.2	4.3		1.62	2.95		-0.38	2.25/36.0	
ETH-17.0	17	2"	100	15	29.6	4.5		1.4	2.44		-0.39	1.55/24.8	
ETH-13.0	13	2" & 1 1/4"	100	15	22.3	4	1.6	1.1	2.44	1.1	0.27	1.30/20.8	Y
ETH-10.0	10	2" & 1 1/4"	100	15	17.7	3.8	1.6	1.1	2.3	1.1	0.27	1.10/17.6	Y
ETH-08.0	8	2" & 1 1/4"	100	15	13.9	3.3	1.7	0.94	2.1	1.2	0.7	0.95/15.2	Y
ETH-06.0	6	2" & 1 1/4"	100	15	10.4	3.5	1.5	0.94	2.1	1.1	0.7	0.97/15.5	Y
ETH-04.7	4.7	2" & 1 1/4"	110	15	8.94	5.4	0.9		2.2		0.25	1.30/20.8	Y
ETH-03.7	3.7	2" & 1 1/4"	110	15	7.04	5	1.1		2.2		0.25	1.10/17.6	Y

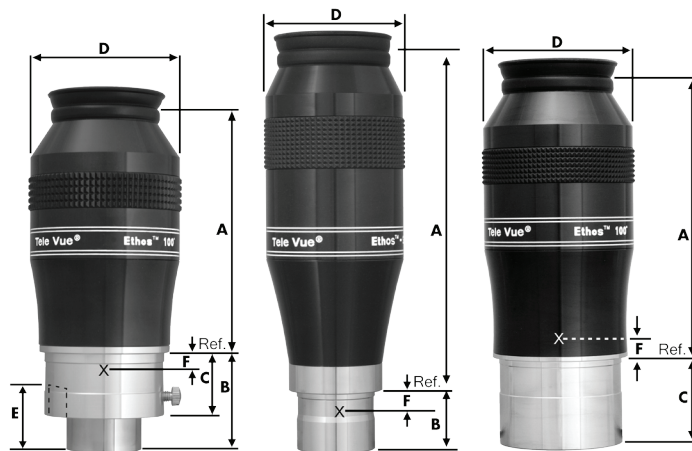

*Eyepiece Dimensions Key

A: Length of barrel above reference surface

B: Length below reference surface

C: Length of 2" barrel

D: Diameter of black barrel

E: Depth of 1/4" barrel

F: Approximate location of field stop

(negative number is above reference surface)

Ref.: Reference surface is location of barrel seat

Tele Vue Scope Magnification, True Field, & Exit Pupil

Focal Length	TV-60	TV-76	NP101is	TV-85	NP127is
21 Ethos	17.1x, 5.76°, 3.5mm	22.9x, 4.32°, 3.3mm	25.7x, 3.84°, 3.9mm	28.6x, 3.46°, 3.0mm	31.4x, 3.14°, 4.0mm
17 Ethos	21.2x, 4.71°, 2.8mm	28.2x, 3.53°, 2.7mm	31.8x, 3.14°, 3.2mm	35.3x, 2.83°, 2.4mm	38.8x, 2.57°, 3.3mm
13 Ethos	27.7x, 3.55°, 2.2mm	36.9x, 2.66°, 2.1mm	41.5x, 2.37°, 2.4mm	46.2x, 2.13°, 1.8mm	50.8x, 1.94°, 2.5mm
10 Ethos	36.0x, 2.82°, 1.7mm	48.0x, 2.11°, 1.6mm	54.0x, 1.88°, 1.9mm	60.0x, 1.69°, 1.4mm	66.0x, 1.54°, 1.9mm
8 Ethos	45.0x, 2.21°, 1.3mm	60.0x, 1.66°, 1.3mm	67.5x, 1.47°, 1.5mm	75.0x, 1.33°, 1.1mm	82.5x, 1.21°, 1.5mm
6 Ethos	60.0x, 1.66°, 1.0mm	80.0x, 1.24°, 1.0mm	90.0x, 1.10°, 1.1mm	100.0x, 0.99°, 0.9mm	110x, 0.90°, 1.2mm
4.7 Ethos SX	76.6x, 1.42°, 0.8mm	102.1x, 1.07°, 0.7mm	114.9x, 0.95°, 0.9mm	127.7x, 0.85°, 0.7mm	140.4x, 0.78°, 0.9mm
3.7 Ethos SX	97.3x, 1.12°, 0.6mm	129.7x, 0.84°, 0.6mm	145.9x, 0.75°, 0.7mm	162.2x, 0.67°, 0.5mm	178.4x, 0.61°, 0.7mm

SFA-0001

This Eyepiece Accepts FONEMATE

If you need a convenient way to take still, video, or timelapse images through an eyepiece, use our FoneMate™ smartphone adapter. It securely clamps to compatible Tele Vue eyepieces. Smartphones as big as the Galaxy Note 4 can be fitted to the FoneMate™.

Enter bit.ly/TVOPTFM in browser URL bar for more info.



EBX-2120

2" EYEPIECE BARREL EXTENDER

Some of our eyepieces have dual 2" / 1 1/4" barrels which make it impossible to use 2" filters due to the 1 1/4" barrel extending below the 2" barrel. The 2" Eyepiece Barrel Extender adds 1.2-inches to the 2" barrel to provide a mounting location for 2" (48mm) eyepiece filters. It also increases backfocus distance and can also help parfocalize eyepiece sets.

Enter bit.ly/TVOPEBX in browser URL bar for more info.



This Eyepiece Accepts BANDMATE™ Filters

Adding Bandmate filters to your eyepiece make nebulae "pop-out" in the field. Bandmate does this by passing select wavelengths of light and blocking other to darken the sky and increase contrast. Several filters are available for 2" and 1 1/4" barrel eyepieces.

- Bandmate Nebustar is a unique narrowband filter design specifically for Tele Vue as a general-purpose nebula filter for scopes of any size. Unlike other ultra-high contrast (UHC) designs, Nebustar blocks red wavelengths normally passed by typical UHC filters. The design eliminates star bloat to produce sharper, more natural looking stars along with enhanced nebulosity.
- Bandmate OIII filter enhances planetary nebulae and supernovae remnants.
- Bandmate Hβ brings out the hydrogen-beta emission lines found in hydrogen emitting nebulae.

Enter bit.ly/TVOPBM2 in browser URL bar for more info.



VIP-2010

VISUAL-IMAGING PARACORR TYPE-2

Newtonian/Dobsonian telescopes can benefit from using a Tele Vue Paracorr (Parabola Corrector) to eliminate coma in the image. Coma is the effect that makes off-center stars appear like little comets (it becomes more apparent as stars move closer to the edge of the field). While a Newtonian/Dobsonian telescope will benefit from the use of Paracorr, those faster than $f/5.0$ will see the greatest results. Stars at the edge of the field will improve so dramatically, that when using top-notch Tele Vue eyepieces an object will be equally sharp anywhere in the field. It also prevents faint stars from disappearing at the edge of the eyepiece field. This is not only aesthetically pleasing, but it also greatly reduces the need to constantly nudge the scope to keep the object centered in the "sweet spot." Just insert Paracorr into your 2" focuser like a 2" Barlow (it has a 1.5% [1.15x] magnification factor) and add Tele Vue eyepieces to suit your needs. It's a recipe for perfection when combined with Tele Vue eyepieces.

The Paracorr Type-2 allows an $f/3$ parabolic mirror to perform like an $f/12$ without it. This permits development of a new generation of larger ladderless Dobs, with bigger, sharper fields than ever before. Indeed, it's already been successfully applied by Mike Lockwood to his 20" $f/3$ and 14.5" $f/2.55$!

This model Paracorr is dual function: the tunable top permits positioning all Tele Vue eyepieces for optimum performance (see eyepiece position chart on the other side), and the optical assembly can be removed for use in an imaging system with DSLR or CCD cameras along with Tele Vue Imaging System accessories.



Enter bit.ly/TVOPTPC in browser URL bar for more info.

Choosing Your Eyepieces

by Al Nagler
CEO, Tele Vue Optics, Inc

MAGNIFICATION

Eyepieces determine your telescope's magnification.

$$\text{Magnification} = \text{telescope focal length} \div \text{eyepiece focal length}$$

TRUE FIELD OF VIEW

Eyepieces also determine the true field you see in the sky. To calculate the true field of view that you will see (in degrees):

$$\text{True field of view} = (\text{eyepiece field stop diameter} \div \text{telescope focal length}) \times 57.3$$

THE FIELD STOP AND APPARENT FIELD OF VIEW

The field stop is the metal ring inside the eyepiece barrel that limits the field size. It's projected by the eyepiece so that it appears as a circle out in space when you look through the eyepiece. The angular diameter of this circle is called the apparent field of view (AFOV) and is a fixed property for each eyepiece design. For example, Plössl and Nagler Zoom eyepieces have an AFOV of 50°, Panoptics have 68°, Delos have 72°, Naglers have 82°, Ethos have 100° and the Ethos-SX eyepiece has 110°.

LOW-TO-MEDIUM POWER VIEWING

For low-power viewing of large objects, or to use your telescope as a low-power finder, use an eyepiece that delivers close to the maximum possible true field of view (note that for 1.25" eyepieces, the maximum field stop diameter is 27mm; for 2" eyepieces, it's 46mm). Then add eyepieces covering uniform increments in smaller field stops. For example, if your widest field eyepiece has a 40mm diameter field stop and you choose a decreasing increment diameter factor of 2 (which results in a 4x decrease in area size), you'll end up with eyepieces having field stop diameters of approximately 40mm, 20mm and 10mm. To further fill in with incremental steps, add eyepieces with approximate field stop diameters of 28mm and 14mm. Of course, avoid duplicating focal lengths. For example, if you use a 31mm Nagler (with a 42mm field stop diameter), you would not need a 32mm Plössl (with a 27mm field stop diameter).

In general, for each field stop size, choosing eyepieces with shorter focal lengths and larger apparent fields of view will allow you to see more detail and fainter stars. In addition, you'll have a smaller exit pupil to better match your eyesight.

EYEGASSES AND EYE RELIEF

If you do not need eyeglasses to correct astigmatism, don't use them when observing. If you wear glasses to correct astigmatism, make sure they're multi-coated, and try to choose eyepieces that have at least 15mm to 20mm of eye relief, to minimize any field reduction (vignetting). However, you will find that with small exit pupils such as 1mm or less, you probably will not need eyeglasses, and can therefore use eyepieces with less eye relief. You can use DIOPTRX instead of eyeglasses for best performance, with Tele Vue eyepieces that accept this accessory.

EXIT PUPIL

The exit pupil is the image of the objective that is formed by the eyepiece. It's where you place your eye to see the full field of view.

$$\text{Exit pupil} = \text{eyepiece focal length} \div \text{telescope } f\#\$$

For reflecting telescopes, it's best to avoid exit pupils larger than 7mm or smaller than 0.5mm. Refracting telescopes have no upper limits on exit pupil sizes.

IMAGE AMPLIFIERS (Barlows and Powermates)

You can also choose a long focal length eyepiece with comfortable eye relief and use image amplifying lenses to increase power. Tele Vue makes Barlows and Powermates (an improvement to the Barlow-type design) in magnification factors of 2x, 2.5x, 3x, 4x and 5x.

PARACORR Type-2 (Parabola Corrector)

If you have a Newtonian or Dobsonian reflector that's $f/5.0$ or faster, you should seriously consider using the Paracorr to eliminate coma, so your full field eyepiece sharpness is not compromised. Paracorr also acts like a 1.15x image amplifier, so, for example, a 1000mm $f/4.5$ scope becomes an 1150mm $f/5.2$ scope. Adjust your eyepiece focal length choices accordingly. Paracorr Type-2 is for scopes as fast as $f/3.0$.

HIGH-POWER VIEWING

Once you've selected an eyepiece set based on field stop sizes, calculate the magnifications produced with your scope. For planetary or double star observing, you'll want an eyepiece in at least the 150x range. For determining maximum power, a good rule of thumb is to use no more than 60x per inch of aperture for scopes with apertures up to 6". Higher magnifications may still be pleasing but will not likely reveal any additional detail. Realistically, the atmosphere will usually limit your planetary observing to a maximum magnification of about 300x, no matter how large your telescope aperture.

Basically, you'll be choosing low and medium power eyepieces by field stop increments to "frame" the subject, and high power eyepieces by magnification increments (based on your scope's aperture), to reach the optimum contrast and resolution for viewing planets and double stars.

Check out www.televue.com for the following related articles: "Choosing Your Telescope's Magnification", "Eyepieces for Small Dobs" and "Determining When To Use Eyeglasses".

For more individual advice on specific applications, you can always call Tele Vue at 845-469-4551

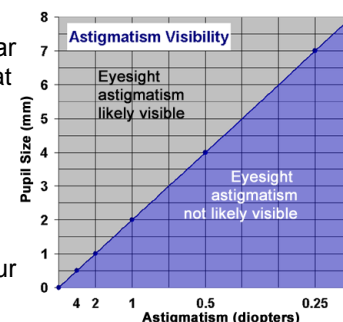

TELE VUE EYEPIECE SPECIFICATIONS

Tele Vue recommends choosing low and medium power eyepieces in ratios of field stop diameters. For example, factors of 1.4 or 2.0. When choosing higher power eyepieces, use ratios of magnification.

Focal Length (mm)	Type	Product Code	Apparent Field (deg)	Field Stop Dia. (mm)	Eye Relief (mm)	Dioptx Ready	Pupil size in mm for various f/ratio telescopes				
							f/4.5	f/5.2	f/7	f/10	f/14
2" Eyepieces for Wide True Fields											
55	Plössl	EPL-55.0	50	46.0	38	Y	12.2	10.6	7.9	5.5	3.9
41	Panoptic	EPO-41.0	68	46.0	27	Y	9.1	7.9	5.9	4.1	2.9
31	Nagler 5	EN5-31.0	82	42.0	19	Y	6.9	6.0	4.4	3.1	2.2
35	Panoptic	EPO-35.0	68	38.7	24	Y	7.8	6.7	5.0	3.5	2.5
21	Ethos	ETH-21.0	100	36.2	15	Y	4.7	4.0	3.0	2.1	1.5
22	Nagler 4	EN4-22.0	82	31.1	19	Y	4.9	4.2	3.1	2.2	1.6
27	Panoptic	EPO-27.0	68	30.5	19	Y	6.0	5.2	3.9	2.7	1.9
17	Ethos	ETH-17.0	100	29.6	15	Y	3.8	3.3	2.4	1.7	1.2
17	Nagler 4	EN4-17.0	82	24.3	17	Y	3.8	3.3	2.4	1.7	1.2
1 1/4" Eyepieces for Wide True Fields											
40	Plössl	EPL-40.0	43	27.0	28	Y	8.9	7.7	5.7	4.0	2.9
32	Plössl	EPL-32.0	50	27.0	22	Y	7.1	6.2	4.6	3.2	2.3
24	Panoptic	EPO-24.0	68	27.0	15	Y*	5.3	4.6	3.4	2.4	1.7
13	Ethos	ETH-13.0	100	22.3	15	Y	2.9	2.5	1.9	1.3	0.9
16	Nagler 5	EN5-16.0	82	22.1	10	N	3.6	3.1	2.3	1.6	1.1
19	Panoptic	EPO-19.0	68	21.3	13	Y*	4.2	3.7	2.7	1.9	1.4
25	Plössl	EAP-25.0	50	21.2	17	N	5.6	4.8	3.6	2.5	1.8
17.3	Delos	EDL-17.3	72	21.2	20	Y	3.8	3.3	2.5	1.7	1.2
18.2	DeLite	EDE-18.2	62	19.1	20	Y	4.0	3.5	2.6	1.8	1.3
10	Ethos	ETH-10.0	100	17.7	15	Y	2.2	1.9	1.4	1.0	0.7
13	Nagler 6	EN6-13.0	82	17.6	12	Y*	2.9	2.5	1.9	1.3	0.9
14	Delos	EDL-14.0	72	17.3	20	Y	3.1	2.7	2.0	1.4	1.0
20	Plössl	EAP-20.0	50	17.1	14	N	4.4	3.8	2.9	2.0	1.4
11	Apollo	EAL-11.0	85	16.2	18	Y	2.4	2.1	1.6	1.1	0.8
15	DeLite	EDE-15.0	62	16.0	20	Y	3.3	2.9	2.1	1.5	1.1
1 1/4" Eyepieces for Medium Powers											
12	Delos	EDL-12.0	72	15.0	20	Y	2.7	2.3	1.7	1.2	0.9
13	DeLite	EDE-13.0	62	13.8	20	Y	2.9	2.5	1.9	1.3	0.9
10	Delos	EDL-10.0	72	12.7	20	Y	2.2	1.9	1.4	1.0	0.7
15	Plössl	EAP-15.0	50	12.6	10	N	3.3	2.9	2.1	1.5	1.1
9	Nagler 6	EN6-09.0	82	12.4	12	Y*	2.0	1.7	1.3	0.9	0.6
11	DeLite	EDE-11.0	62	11.7	20	Y	2.4	2.1	1.6	1.1	0.8
9	DeLite	EDE-09.0	62	9.6	20	Y	2.0	1.7	1.3	0.9	0.6
11	Plössl	EAP-11.0	50	9.1	8	N	2.4	2.1	1.6	1.1	0.8
1 1/4" Eyepieces for Higher Powers											
8	Ethos	ETH-08.0	100	13.9	15	Y	1.8	1.5	1.1	0.8	0.6
6	Ethos	ETH-06.0	100	10.4	15	Y	1.3	1.2	0.9	0.6	0.4
8	Delos	EDL-08.0	72	9.9	20	Y	1.8	1.5	1.1	0.8	0.6
7	Nagler 6	EN6-07.0	82	9.7	12	Y*	1.6	1.3	1.0	0.7	0.5
4.7	Ethos SX	ETH-04.7	110	8.9	15	Y	1.0	0.9	0.7	0.5	0.3
6	Delos	EDL-06.0	72	7.6	20	Y	1.3	1.2	0.9	0.6	0.4
7	DeLite	EDE-07.0	62	7.5	20	Y	1.6	1.3	1.0	0.7	0.5
3.7	Ethos SX	ETH-03.7	110	7.0	15	Y	0.8	0.7	0.5	0.4	0.3
5	Nagler 6	EN6-05.0	82	7.0	12	Y*	1.1	1.0	0.7	0.5	0.4
8	Plössl	EAP-08.0	50	6.5	6	N	1.8	1.5	1.1	0.8	0.6
4.5	Delos	EDL-04.5	72	5.6	20	Y	1.0	0.9	0.6	0.5	0.3
5	DeLite	EDE-05.0	62	5.3	20	Y	1.1	1.0	0.7	0.5	0.4
3.5	Nagler 6	EN6-03.5	82	4.8	12	Y*	0.8	0.7	0.5	0.4	0.3
3.5	Delos	EDL-03.5	72	4.4	20	Y	0.8	0.7	0.5	0.4	0.3
4	DeLite	EDE-04.0	62	4.3	20	Y	0.9	0.8	0.6	0.4	0.3
3	DeLite	EDE-03.0	62	3.2	20	Y	0.7	0.6	0.4	0.3	0.2
1 1/4" Zoom Eyepieces for Medium and Higher Powers											
6-3	Nagler Zoom	ENZ-0306	50	5.1-2.6	10	N	1.3-0.7	1.2-0.6	0.9-0.4	0.6-0.3	0.4-0.2

NOTE: True Field in degrees = (Field Stop dia./Telescope Focal Length) X 57.3°

*Indicates additional Dioptx Adapter required

As of January 2012, all Tele Vue eyepieces have a limited lifetime warranty.



32 Elkay Dr., Chester, New York, 10918 (845) 469-4551 televue.com