

Wireless Smart Camera ASI2600MC Air User Manual



Thank you for purchasing the ZWO ASI camera! Please read this manual carefully before using this product. The copyright and modification rights of this manual and other related materials belong to Suzhou ZWO Co., Ltd.

Contents

Foreword.....	1
Tips for Reading this Manual	2
1. Product Overview.....	5
2. Notice for Use	11
3. Getting to Know the Camera.....	13
3.1. External View.....	13
3.2. Specifications.....	16
3.3. Product Related Certification	19
3.4. Quantum Efficiency and Read Noise	20
3.5. Analog to Digital Converter (ADC)	22
3.6. Cooling System.....	23
3.7. Anti Dew	24
3.8. Power Consumption	25
3.9. Built-in UV-IR Cut Filter.....	25
3.10. DDR Buffer	26
3.11. Antenna	27
4. What's in the Box?	28
5. Structural Dimension Diagram	29
6. Connection Methods	30
6.1. Data Cable Connection.....	30
6.2. Power Supply Connection.....	31
6.3. Network Connection	33
6.4. Mount Connection via Cables	34
6.5. Mount Connection via Network	38
6.6. Telescope Connection	38
6.7. Lens Connection.....	39
7. Astrophotography with ASIAIR App.....	40
7.1. Interface Overview.....	40
7.1.1. Home.....	40
7.1.2. Community	41
7.1.3. Nearby	42
7.1.4. Me.....	43
7.2. Basic Configuration.....	44
7.2.1. Gear Profile	44
7.2.2. Wireless Smart Camera.....	46
7.2.3. Main Camera	48
7.2.4. Guiding	50
7.2.5. Mount.....	52
7.2.6. Filter Wheel	54
7.2.7. EAF.....	56
7.2.8. Storage	57

7.2.9. About	59
7.3. Imaging Guide	60
7.3.1. Telescope Focusing.....	60
7.3.2. Polar Alignment	62
7.3.3. GoTo.....	67
7.3.4. Preview and Composition	69
7.3.5. Start Guiding.....	70
7.3.6. Live Stack	74
7.3.7. Autorun	75
7.3.8. Plan Mode	76
7.3.9. Others.....	77
8. Astrophotography with ASIStudio	84
8.1. Download and Install ASIStudio.....	84
8.2. Connect the Camera and Capture Images	85
8.3. Additional Astrophotography Software.....	87
9. Others	91
9.1. Firmware Update	91
9.2. Wi-Fi Reset	91
10. Servicing & Warranty	92
11. Contact Us	92

Foreword

Thank you for buying the ZWO wireless smart camera! This camera is a highly integrated smart Wi-Fi device that integrates an imaging sensor, a guiding sensor and a smart astrophotography controller. Independently developed by ZWO, this wireless smart camera series opens a new chapter in astrophotography with its advanced product concept and highly integrated product design.

Before you use this camera, please take some time to read this manual. You may need a few hands-on exercises to familiarize yourself with the use of this camera. This manual provides detailed reference information for each step in use and detailed description of the relevant functions, so as to ensure your use of a simple and pleasant experience.

By means of text description and legend, this manual reminds the user of possible improper operation. Be sure to follow the instructions before actually using it. Any equipment damage and personal injury caused by improper operation shall be borne by the user himself.

Tips for Reading this Manual

Search for keywords

You can use the search function to search for keywords in this PDF document. For example, in Adobe Reader, Windows users can search for keywords using CTRL + F and MAC users can search for keywords using Command + F.

Click the table of contents to jump

You can see the content structure of this document through the table of contents, click on the title to jump to the corresponding page.

Print the document

You may also print this document if you prefer reading print instead of digital text.

Usage advice

ZWO provides the owners of wireless smart cameras with instructional videos and documentation. Since the manual is subject to change in the future, for up-to-date instructions on how to use this camera, you may also refer to the Quick Guide of this product available at

<https://www.zwoastro.com/guides-and-manuals/>

Get the tutorial video

You can scan the QR code by mobile phone to obtain and watch the tutorial video of this product.



Download ZWO ASI AIR App

Scan the QR code for download addresses. iOS users can search "ASI AIR" in the App Store. Android users can search "ASI AIR" in Google Store or directly download the APK file on the ZWO website.

#Mobile devices refer to smart devices (such as phones and tablets) that support iOS or Android operating systems and have internet connectivity.

The ASI AIR App requires Android 8.0 and above, or iOS 12 and above.



Minimum and recommended system configuration

For the best experience, we recommend you run the ASI AIR App on devices above the recommended configuration.

	Android	iOS	MacOS
Minimum requirement	Android 8 and above, RAM > 4GB	iOS 12 and above	Mac devices with Apple Silicon
Recommended configuration	Android 12 and above, RAM > 6GB	iOS 15 and above	Mac devices with Apple Silicon

Disclaimer

This product is not a toy. Do not allow children to touch this product or its parts or cables. Please be careful when operating in the presence of children.

For astrophotography enthusiasts who are just getting started, this product requires a period of learning and some basic knowledge of astronomy. Do read the entire manual and familiarize yourself with the functions of the product before operating it. Failure to operate the product properly may result in product damage and property damage.

For more service terms, please refer to the Service Agreement in the App. ZWO does not assume any losses caused by users not using the product in accordance with this manual.

Subject to laws and regulations, ZWO reserves the final right of interpretation of this document. ZWO reserves the right to update, revise or terminate this document without prior notice.

1. Product Overview

The wireless smart camera case is made of high-quality aviation aluminum and machined by CNC. After surface anodizing and sanding, it not only protects the case well, but also has a comfortable feel. The size of the entire camera is similar to other ZWO deep space cameras. The interfaces are standardized, easy to install and easy to use.

The wireless smart camera is highly integrated with an imaging sensor, a guiding sensor and a smart astrophotography controller into one camera body. It also integrates eMMC storage with large storage space. It simplifies installation steps and avoids messy cable tangles, offering a stable and durable connection between multiple devices so that users can focus on and take pictures more efficiently.

The camera comes with an external enhanced dual-band antenna, supporting 2.4G and 5G frequency bands, and can be used stably and smoothly within 20 meters*.

*20 meters is the statistical average of multiple tests of the 2.4G frequency band in an open area. And 2.4G has a longer transmission distance than 5G and a slightly slower transmission speed.











The camera supports the power supply and control of multiple hardware such as mount and electric focuser. Through the intelligent App, various imaging modes can be realized. A good software interactive experience can be achieved, and one-click image-processing can also be carried out so that users can get a high-quality image with ease.

Relying on ZWO's multiple patented technologies, the stability of the system and the accuracy of imaging are guaranteed, and the App supports OTA upgrades. The professional and mature technical R&D

team continuously enriches product functions and continuously improves user experience.

Main Sensor



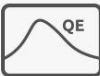
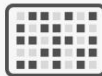



The main sensor IMX571 features an APS-C format and 26MP total pixels. The size is 23.5mm in width and 15.7mm in height, and the diagonal is 28.3mm. The 3.76um x 3.76um small pixel size accommodates an impressive full depth of 50ke. With the new hardware technology, it is even extended to 73ke*. Besides these features, it also has great characteristics such as very low read noise and zero amp glow.

 Sensor IMX571	 APS-C 23.5×15.7mm	 Resolution 6248×4176	 ADC 16bit
 Read noise 0.9e-4.2e	 Cooling Tempe 30°C-35°C	 eMMC 256GB	 Wi-Fi 5 2.4Ghz/5Ghz
 FPS 10.8(1920×1080)	 Full well 50Ke	 QE 80%	 Pixel Size 3.76μm

*Note: The full well capacity of ASI2600MC Air is 50Ke by default. At gain -25, the full well capacity can be extended to 73Ke.

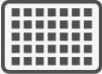
Guide Sensor

The SC2210 sensor taken from the ASI220MM Mini camera features very high sensitivity. The QE peak value reaches 92% at 500nm. The read noise is as low as 0.6e. As the new generation of guide sensor, it has achieved great results in guiding, and proven by hundreds of astrophotographers.

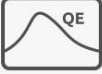
 Sensor SC2210	 1/1.8" 7.68×4.32mm	 Resolution 1920×1080	 ADC 12bit
 Read noise 0.6e	 FPS 8.5 (1920×1080)	 QE 92%	

Three-in-one design

Thanks to the compact design, the ASI2600MC Air only needs one USB cable for control. It reduces potential cabling issues and improves setup speeds. You don't need a separate OAG, guide camera and ASIAIR. The camera supports automatic guiding, multi-target imaging and fast image processing.

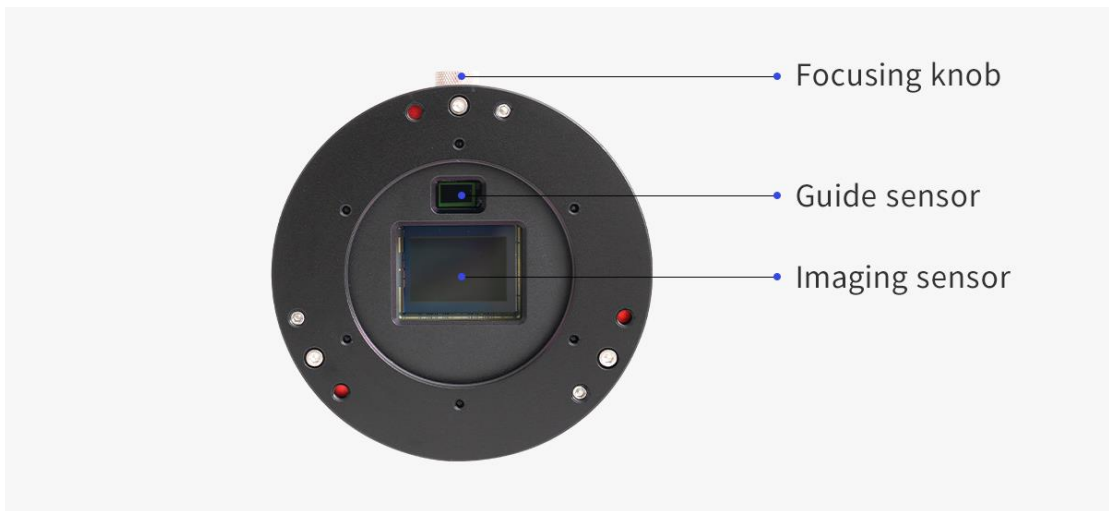

Tilt adjustment from rear (Optional)

The 3 points from the rear make tilt adjustment much easier without the trouble of removing the tilt plate from the camera.



STARVIS technology

ASI2600MC Air's main sensor based on Sony STARVIS technology. Sony's back-illuminated CMOS image sensor improves sensitivity and noise reduction – the key factors to enhancing image quality.

The word "STARVIS" is displayed in a bold, white, sans-serif font, centered within a black rectangular background.

No amp-glow

Traditional CMOS sensors produce a weak infrared light source during operation quite often seen in the corner of uncalibrated images. It is the tell-tale sign of amp glow. As the ASI2600MC Air uses zero-amp glow circuitry, you won't have to worry about amp glow even when using high gain, long exposure imaging.

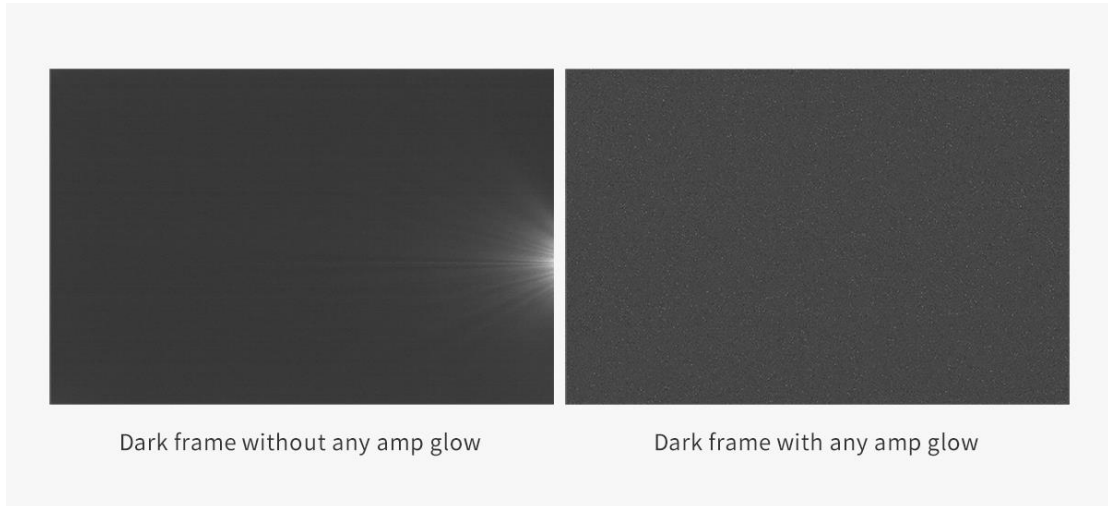

Native 16bit ADC

This 16bit ADC is not a CCD 16bit ADC. It can really achieve a dynamic range output of 14stops, which will significantly improve the image sharpness and contrast, and also create smoother and more natural color transitions.

Resolution	Video mode
1920 x 1080	10.8fps
1280 x 960	14.2fps
1280 x 720	18.2fps
640 x 480	23.8fps
480 x 360	32.8fps
320 x 240	36.4fps

ASI2600MC Air can reach 10fps in RAW16 high-speed mode, which is faster and more stable.

2. Notice for Use

Before using the product, please carefully read the following guidelines:

1. Cameras with cooling functions require a DC12V@3A~10A power adapter (connector specification is D5.5x2.1mm, positive inside, negative outside). Additionally, 11V~14V lithium batteries can also power the camera. Using any power sources outside of this range may cause irreversible damage to the camera.

2. Only one power port can be used as the power input resource. It is prohibited from accessing multiple power inputs.

3. Ensure that the wireless smart camera operates in a well-ventilated environment.

4. Ensure that the connection cables between the wireless smart camera and other devices are not tangled. Pay particular attention to the communication cable and power cable connected to the equatorial mount.

5. Use the camera only in favorable weather conditions (not during rain, snow, heavy fog, lightning, strong winds, or extreme weather). Using or storing the camera outside of the specified conditions may cause damage.

Storage Temperature	-20°C ~ 60°C
Operating Temperature	-20°C ~ 50°C
Operating Humidity	20% ~ 90%
Storage Humidity	30% ~ 70%

6. Before the image is completely exported to a USB drive or transferred from the camera to a computer, do not disconnect the USB drive or Type-C cable to avoid data loss or damage to the storage device.

ZWO is not responsible for any data stored in the product and will not provide compensation for such data.

7. During the activation of the wireless smart camera, do not put the ASIAIR App in the background or close it, and do not cut off the power supply to the camera.

8. Online authorization is only required for your first use of the camera. It needs an Internet connection so make sure the network at your place works well.

9. If the wireless smart camera operates for an extended period in extremely high temperatures, the device's temperature may rise to uncomfortable levels. Avoid touching the device immediately after cutting off the power.

10. Do not use corrosive solutions to clean the camera to prevent damage.

11. Avoid exposing the camera to direct sunlight for prolonged periods to prevent surface discoloration.

12. Do not use the device for long periods under under-voltage conditions.

3. Getting to Know the Camera

3.1. External View

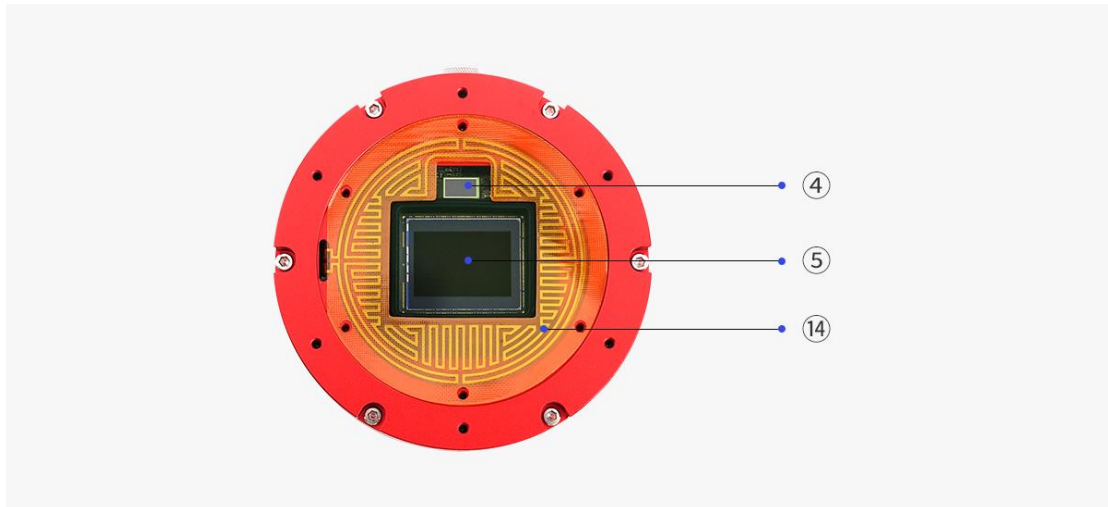

No.	Name	Specification	Quantity	Note
1	Heat sink		1	
2	Focusing knob		1	For focusing the guiding sensor
3	Sensor tilt plate	M54x0.75 threads, 5mm thickness	1	Removable
4	Guiding sensor	SC2210_BW	1	

5	Main Sensor	SONY IMX571	1	
6	Protective window	D60x2mm	1	UV/IR CUT coating for OSC camera, AR coating for mono camera
7	Power status indicator		1	The red light is always on when the power supply is normal. The red light is off when the power supply is abnormal. Turning on/off the indicator is supported on the App
8	DC IN/OUT	Power input/output port, D5.5x2.1mm, DC12V@3A~10A (positive inside, negative outside). 11V~14V lithium batterie is also supported	3	Only one DC port can be used as power input
9	Ultra-quiet magnetic levitation fan		1	
10	USB 2.0 port	Can be used to connect EAF and EFW	4	
11	RESET button		1	When Wi-Fi is abnormal, you can reset Wi-Fi. To do this, press and hold the RESET button for 5 seconds, and release it after the voice broadcast says "WiFi reset successful, waiting for connection". The hotspot, password, and Network bridge data will be reset successfully.

12	Wi-Fi antenna port		1	For installing the Wi-Fi antenna
13	Type-C port		1	Can be used to transfer image data to PC
14	Dew-heater (inbuilt)		1	Avoid dew issues

3.2. Specifications

Product Name	Wireless Smart Camera
Model	ASI2600MC Air
Dimensions	Camera body: Ø90mm, 98mm height Antenna: 94mm long
Weight	770g
Operating Temperature	-20°C~50°C
Storage Temperature	-20°C~60°C
Operating Humidity	20% ~ 90%
Storage Humidity	30% ~ 70%
RAM	2GB DDR4
Storage Space	eMMC 256GB
Wireless Network	IEEE 802.11a/b/g/n/ac, 2.4Ghz-5Ghz, Effective transmission distance: 20m
DC Power	12V@3A-10A input. All three DC ports can be used both as input and output. You can use any one among them as power input, meanwhile the other two can only be used as DC output.
HUB	USB 2.0 - HUB *4
OS	Windows/Linux(Aplaca)
Adapter Ring	M54x0.75
Back Focus	12.5mm or 17.5mm
Power Mode	DC12V-3A
Max Power Dissipation	27.6W

Main sensor and guide sensor:

	Main Camera	Guide Camera
Characteristic		







Sensor	SONY IMX571	SC2210_BW
Color	Color	Mono
Sensor Size	APS-C	Type 1/1.8
Pixel Size	3.76 μ m	4 μ m
Shutter	Rolling shutter	Rolling shutter
Image Resolution	26MP 6248x4176	2.07MP 1920x1080
Spectrum Range	400nm-1000nm	300nm-1000nm
Read Noise	0.84-4.2e (1.4e@10db gain)	0.6-3.2 e(1e@10.6db gain)
Peak Quantum Efficiency	80%	500nm 92%
Full Well Capacity	73Ke*	8.78Ke
Diagonal	28.3mm	8.81mm
Max Frame Rate	36.4fps (320x240)	8.5fps (1920 x 1080)
SNR	14.08stops	11.4stops
Dynamic Range	14bit	11.43bit
Data/Control		
ADC	16bit	12bit
Bin ADC	\	\
HSpeed ADC	12bit	\
Acquisition Mode	Continuous operation, software triggered	Continuous operation, software triggered
Analog Gain	-25dB - 460dB	0dB-350dB
Digital Gain	461dB-820dB (Limited to 700dB)	351dB-600dB
Unity Gain	\	68
HCG Gain	100	106
Exposure Time	32 μ s-2000s	32 μ s~10s

Exposure Control	Auto/Manual	Auto/Manual
Data Format	RAW8、RAW16、RGB24、Mono8、Mono16	RAW8、RAW16、Mono8、Mono16
White Balance	Auto/manual	Auto/manual
Output Format	Raw	Raw
Software Bin	Bin2 Bin3 Bin4	Bin1 Bin2
Offset(recommended)	50	\
Function		
Delta-T	30°C-35°C (tested at the environment temperature of 30°C)	\
Power of Heating Tube	2.88W	\

*Note: The full well capacity of ASI2600MC Air is 50Ke by default. At gain -25, the full well capacity can be extended to 73Ke.

3.3. Product Related Certification

The product meets the following certification requirements:

Certificate	Token
CE	
RCM	
Rohs	
WEEE	
FCC ID: 2A7R3-ASICamera Air	
IC: 28392-ASICamera Air	
MIC(TELEC): 211-240612	

3. 4. Quantum Efficiency and Read Noise

Quantum efficiency (QE) - Main sensor

The QE peak value of ASI2600MC Air's main sensor is estimated to be about 80%.

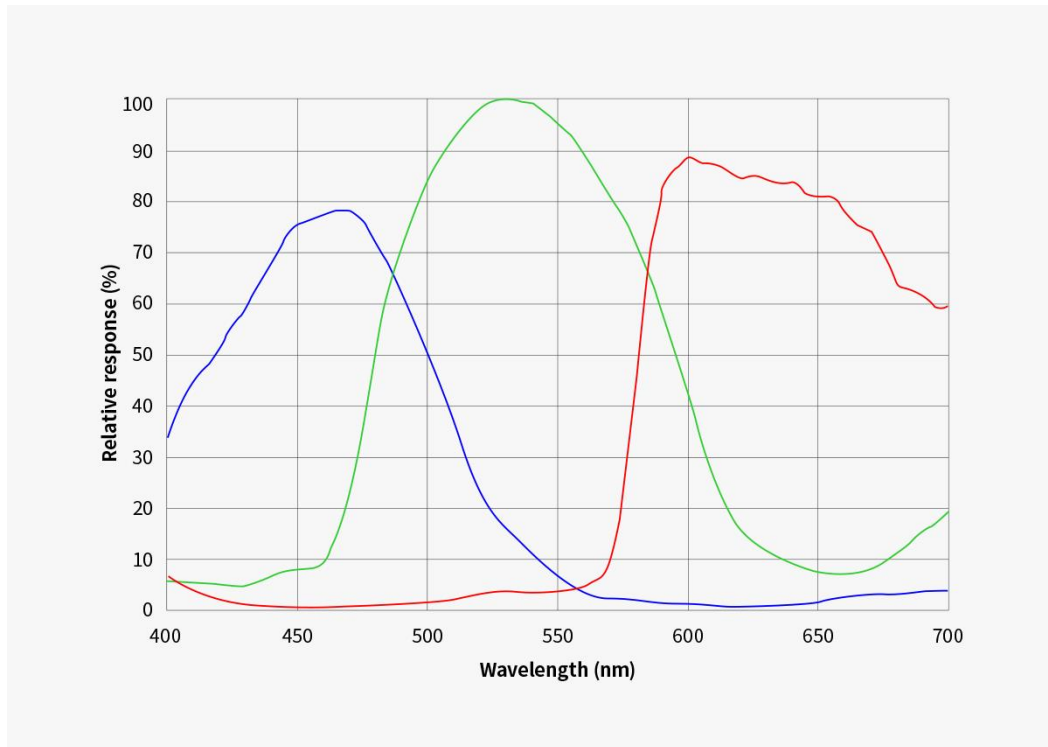

Quantum efficiency (QE) - Guide sensor

The QE peak value of ASI2600MC Air's guide sensor is estimated to be about 92%.

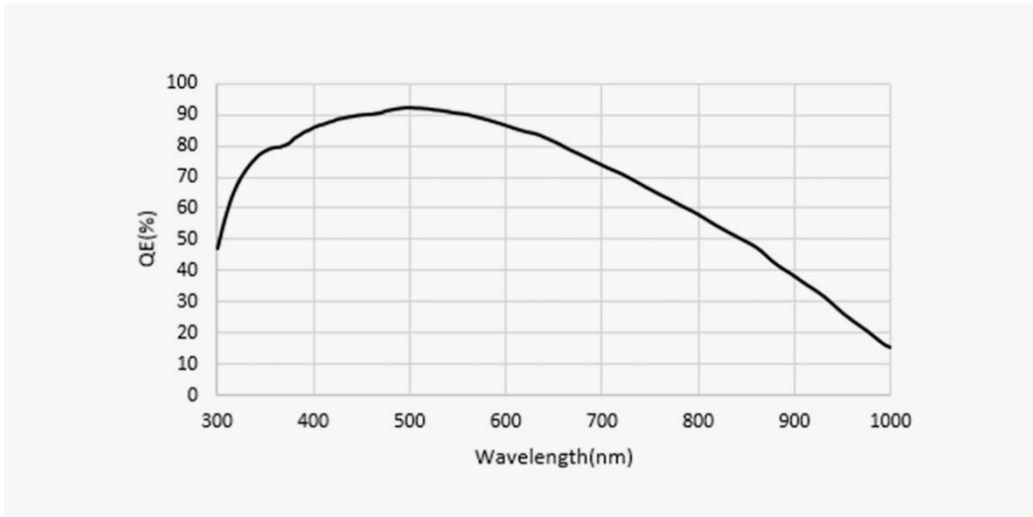

Read noise

Extended full well mode: ASI2600MC Air's full well capacity can be extended to 73Ke, which is 1.46 times the IMX571 sensor with a basic full well capacity of 50ke.

(Pixels will get saturated, causing the image to be overexposed, when the full well capacity is over 73Ke.)

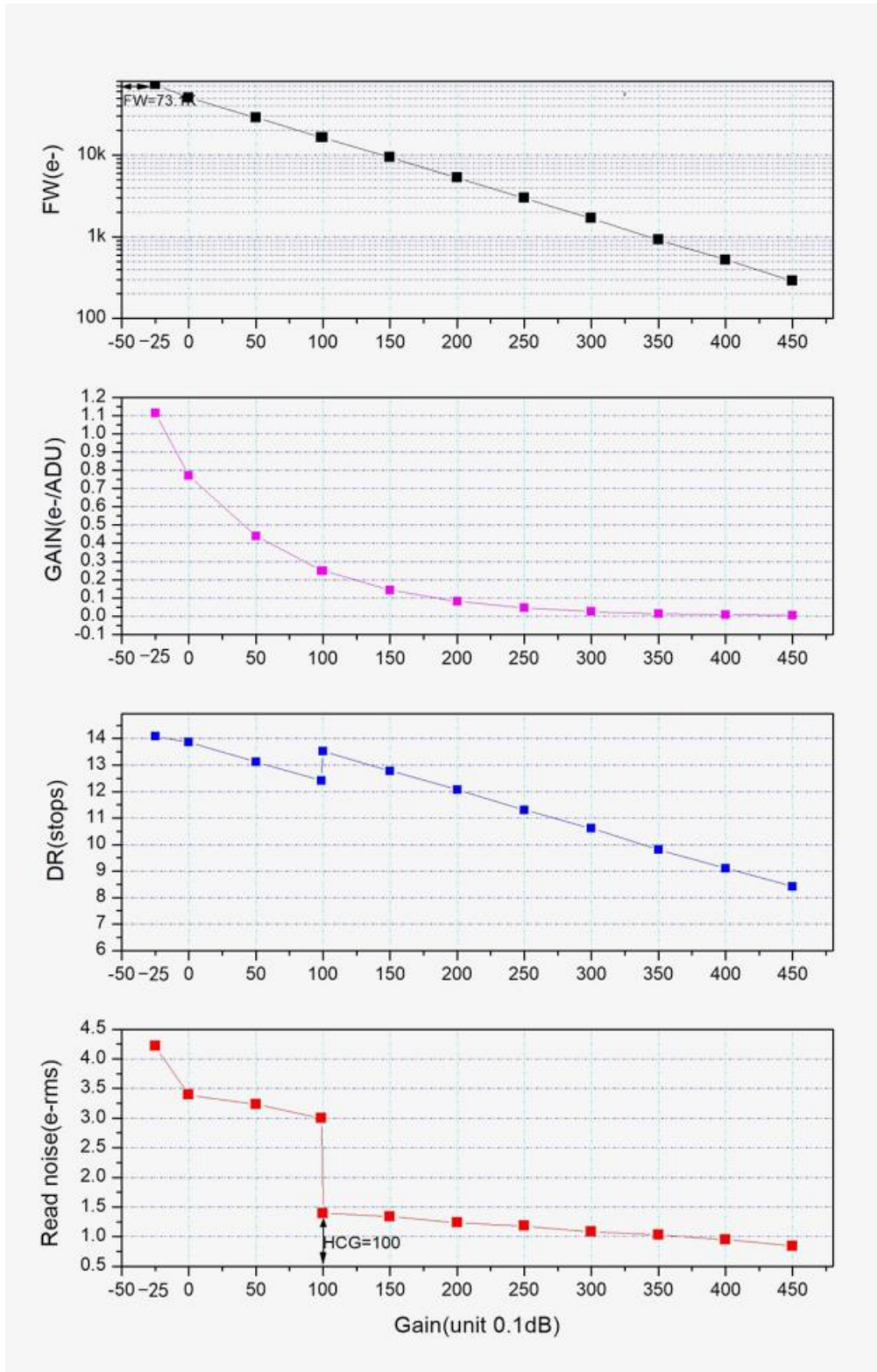

3.5. Analog to Digital Converter (ADC)

ASI2600MC Air has a built-in 16bit ADC. It supports the custom ROI partial readout mode, resulting in a faster frame rate at the smaller ROI

resolutions.

Below are the maximum speeds of ASI2600MC Air running at different USB transmission modes in 16bit mode:

ASI2600MC Air Frame Rate			
Frame rate (IMX571)		Frame rate (SC2210)	
Resolution	RAW8	Resolution	RAW8
1920 × 1080	10.8fps	1920 × 1080	8.5fps
1280 × 960	14.2fps	1280 × 960	8.5fps
1280 × 720	18.2fps	1280 × 720	8.5fps
640 × 480	23.8fps	640 × 480	8.5fps
480 × 360	32.8fps	480 × 360	8.5ps
320 × 240	36.4fps		

3. 6. Cooling System

Two-stage TEC Cooling

Thanks to the two-stage TEC cooling, ASI2600MC Air can lower the CMOS sensor temperature to 30~35°C below ambient temperature (tested based on an ambient temperature of 30°C), which can greatly reduce dark current generation and sensor noise even during extended exposure times.

*As the ambient temperature falls, the Delta T would decrease.

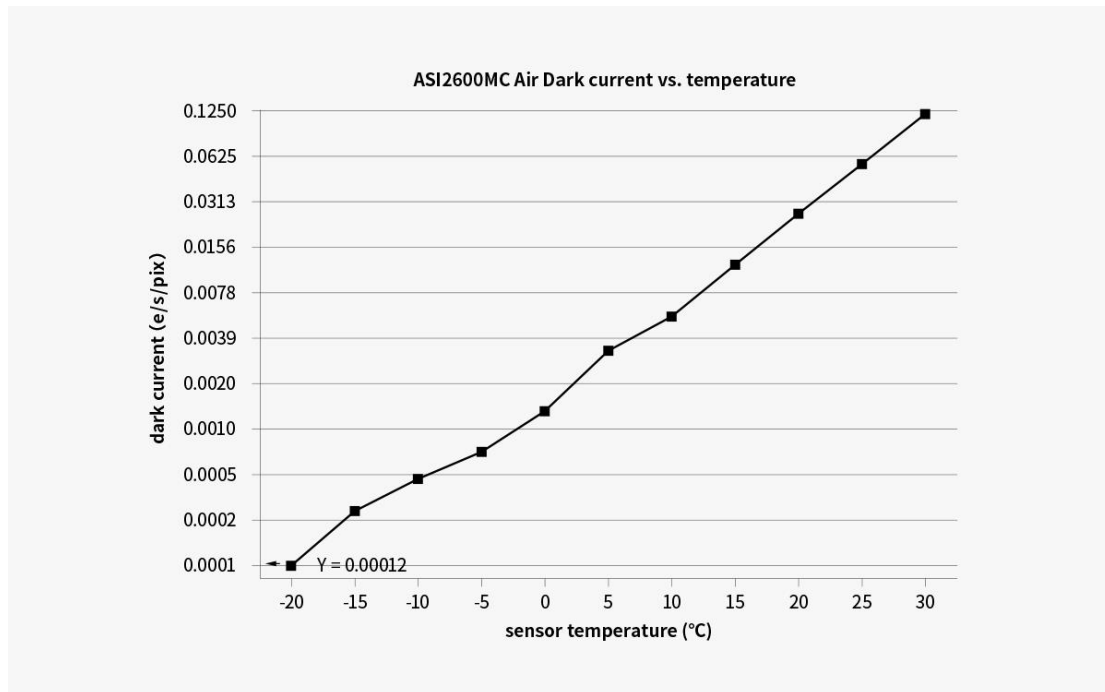

3.7. Anti Dew

Anti dew heater

ASI2600MC Air comes with a polyimide heater that completely fits the protective window to avoid dew problems. Its power consumption is around 2.88W. You can turn this feature off in software if you want to save some power.

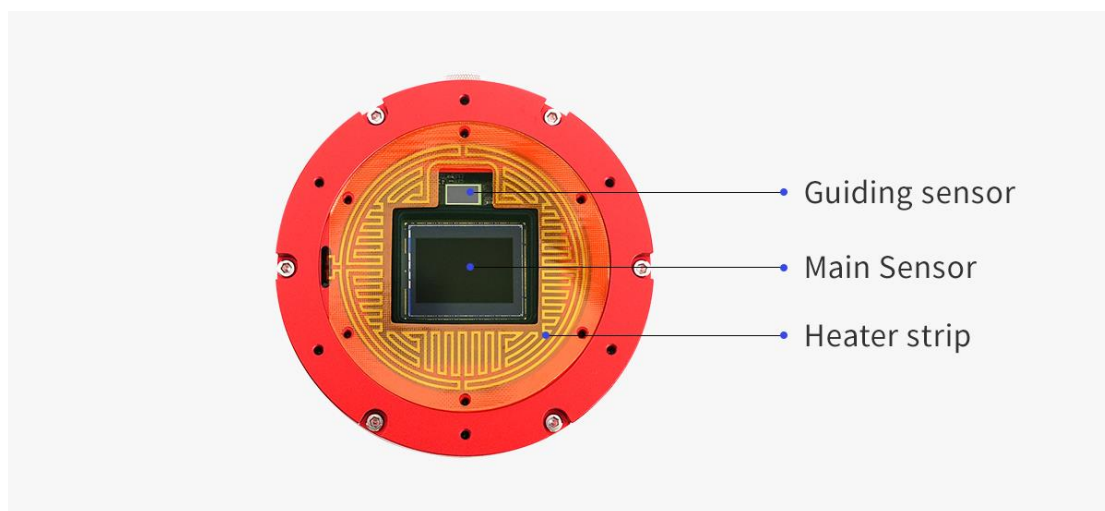

3.8. Power Consumption

All ASI cameras have low power consumption. ASI2600MC Air is no exception. Cameras with cooling functions require a DC12V@3A~10A power adapter (connector specification is D5.5x2.1mm, positive inside, negative outside). Additionally, 11V~14V lithium batteries can also power the camera. Using any power sources outside of this range may cause irreversible damage to the camera.

Below is the power consumption of ASI2600MC Air:

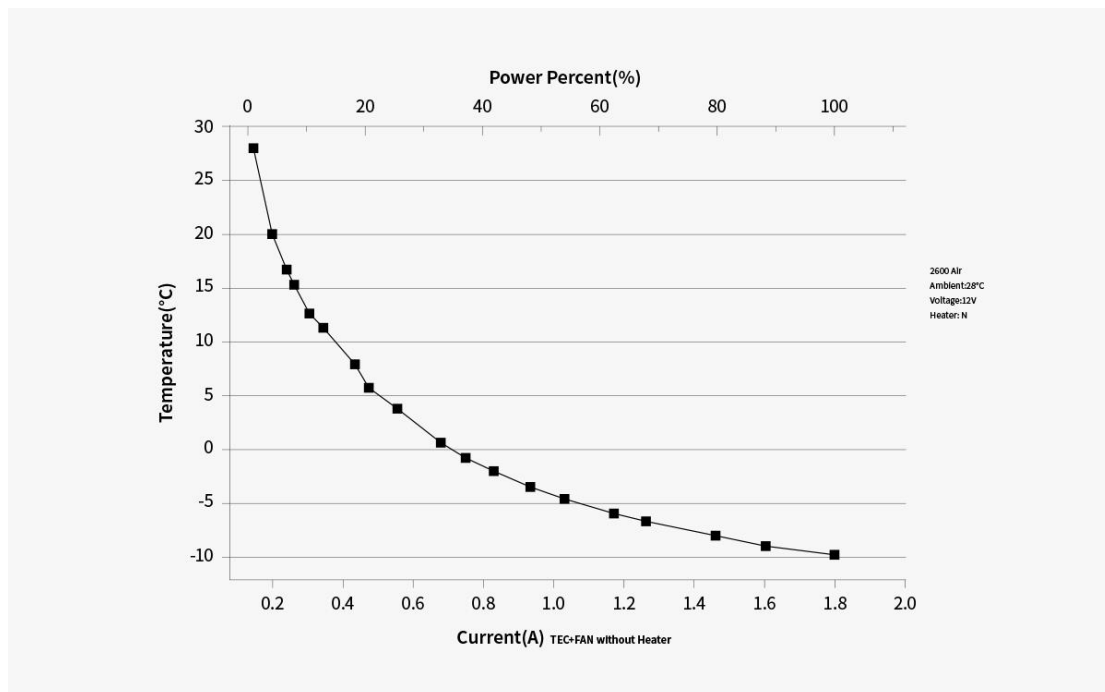

3.9. Built-in UV-IR Cut Filter

The ASI2600MC Air camera is equipped with a UV-IR Cut filter (infrared cutoff filter) in front of the sensor, which serves as a protective window. This filter safeguards the sensor from external damage while effectively reducing infrared light interference, thereby improving image quality.

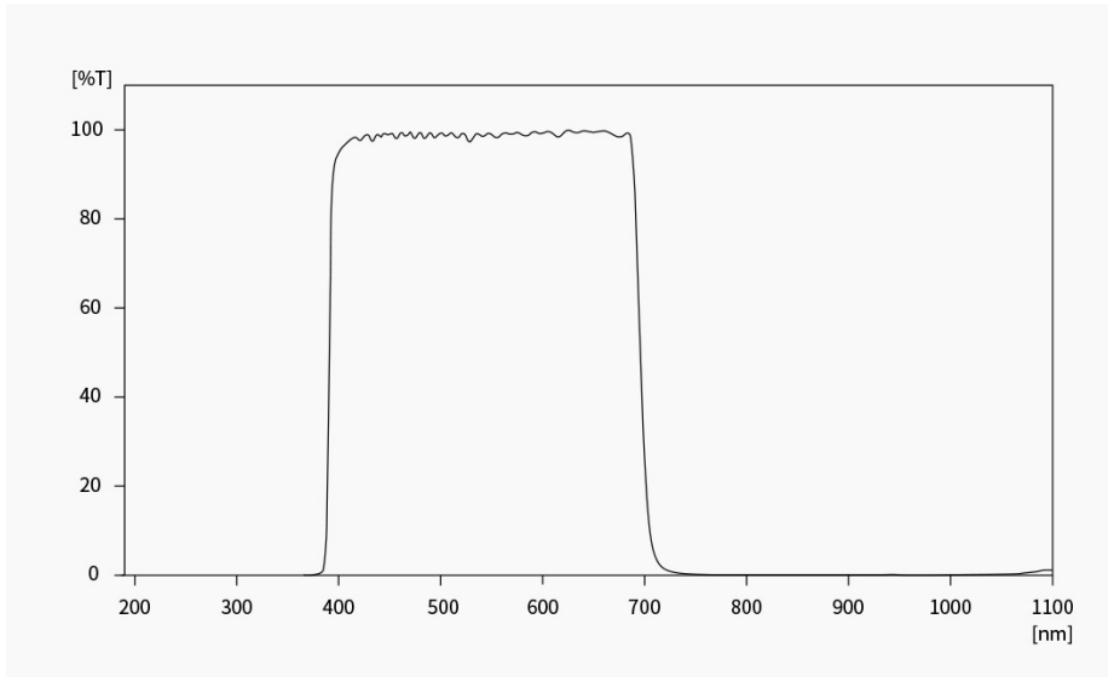

3. 10. DDR Buffer

ASI2600MC Air is integrated with a 2GB DDR4 buffer that ensures the stability and security of data transmission, and effectively avoids the frame dropping issue during long exposure.

3. 11. Antenna

The Wi-Fi antenna of the smart telescope is disassembled in the package. Before you use the camera, you need to install the antenna manually by simply fixing it to the antenna port.



4. What's in the Box?

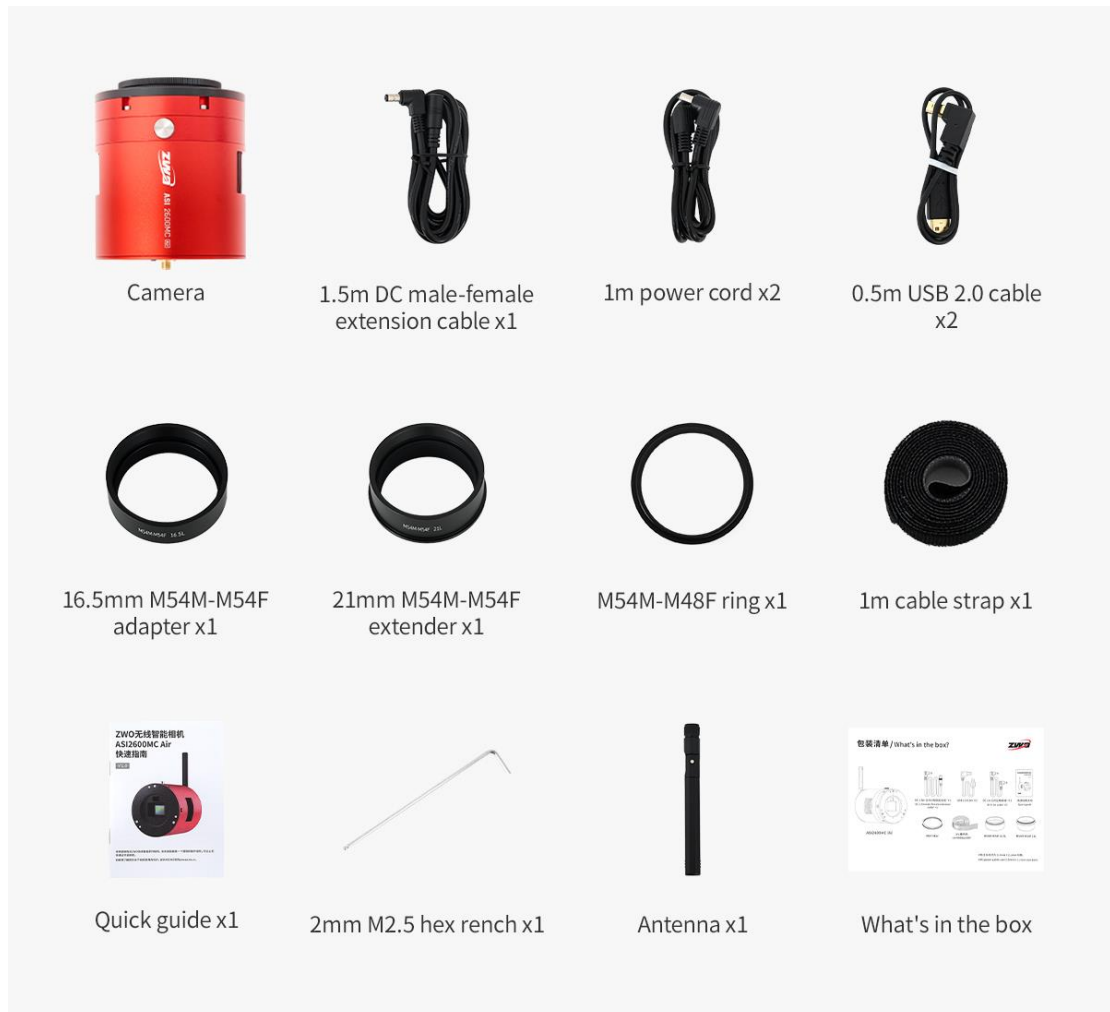

5. Structural Dimension Diagram

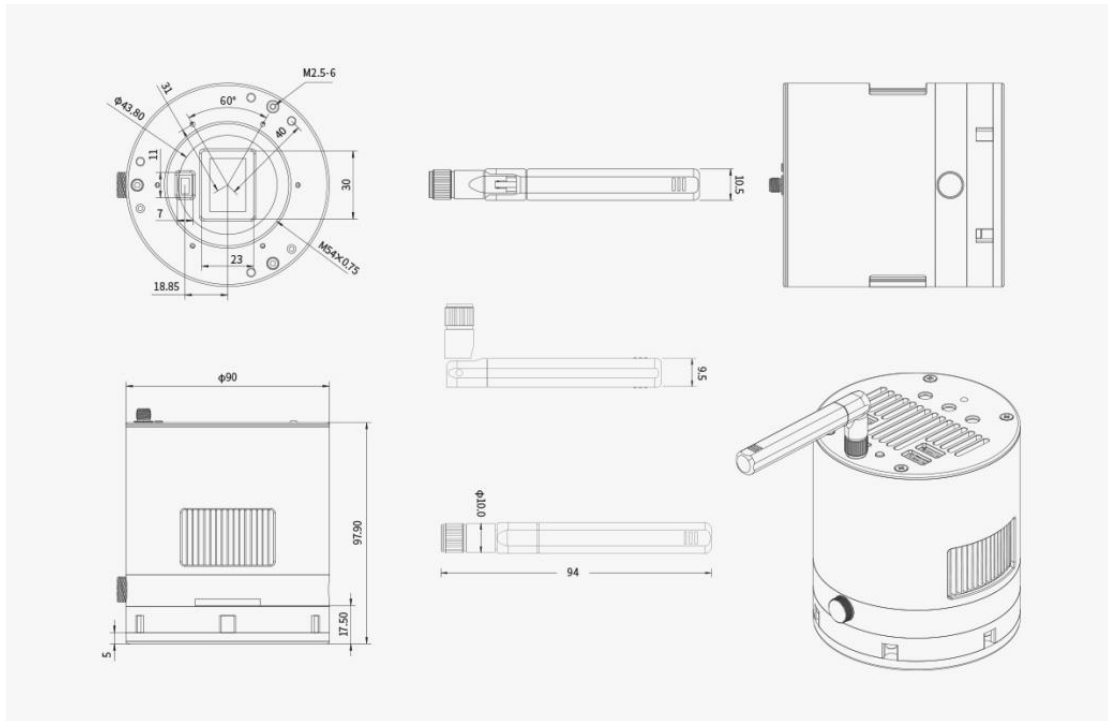

6. Connection Methods

This chapter aims to guide the user on how to connect the wireless smart camera to other devices.

6.1. Data Cable Connection

The wireless smart telescope has multiple USB 2.0 ports to allow you to connect different devices, such as mount, EAF, EFW, etc.

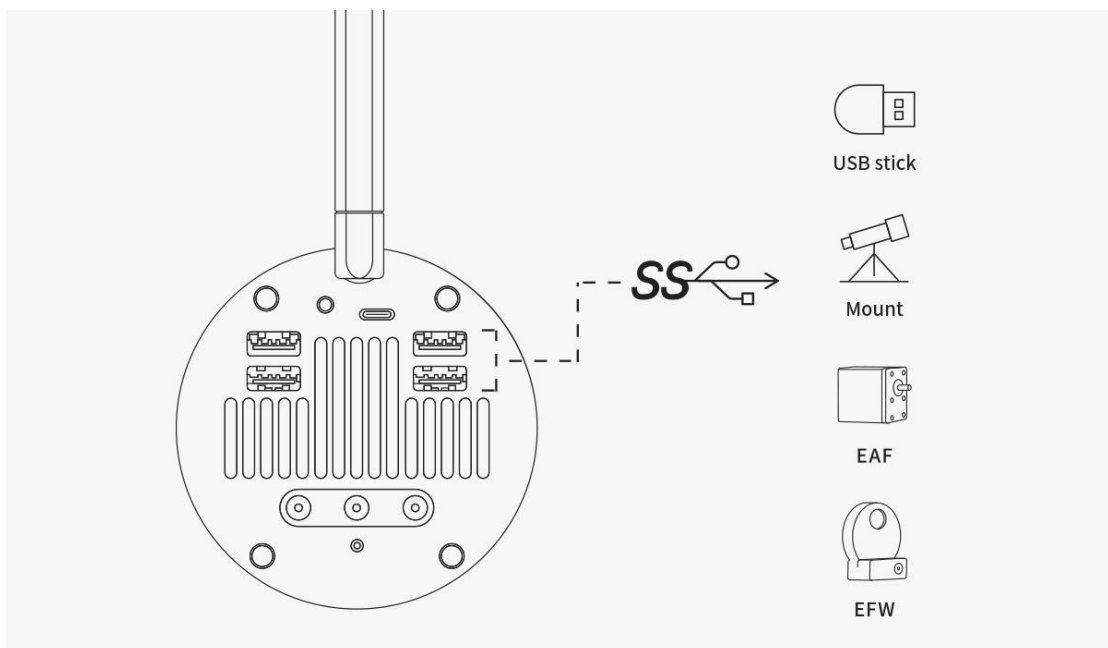

Pay attention to the length of the USB cables to prevent them from tangling during the mount head's rotation.

After you complete the current imaging session, to process the image data, you can use an external USB drive to export the images in the ASIAIR App, or connect the camera to your computer via the USB Type-C port of the camera, and then directly access the data stored in the eMMC memory of the camera.

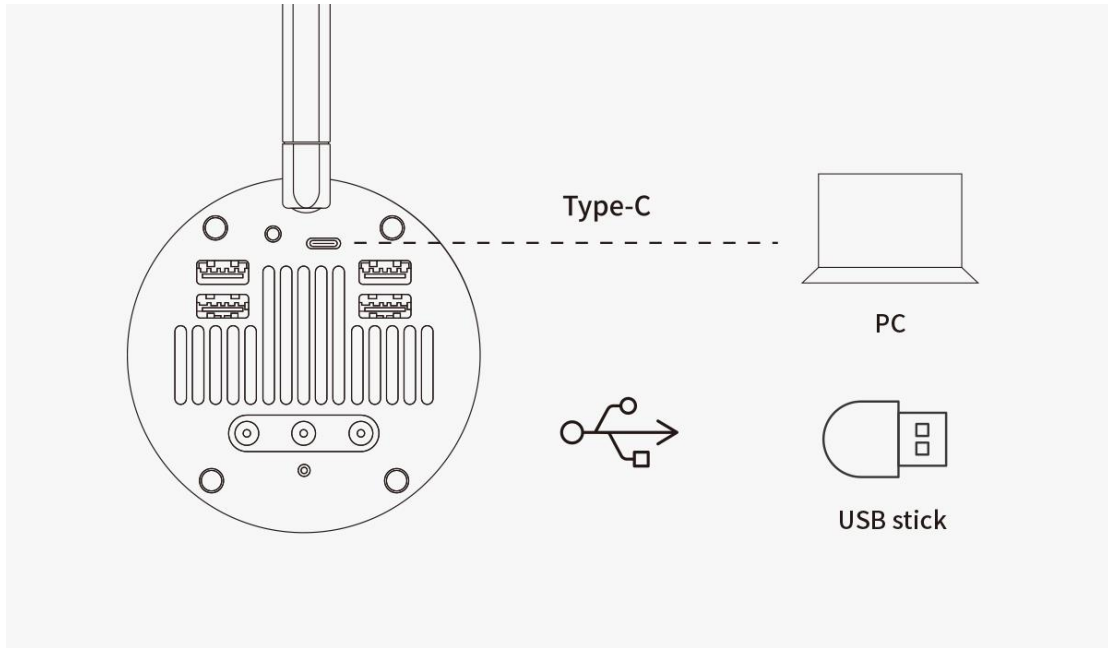

6.2. Power Supply Connection

Use a 12V@5A power adapter to connect the wireless smart camera to a power outlet, or power it with a battery. When powered on correctly, the POWER indicator will light up red.

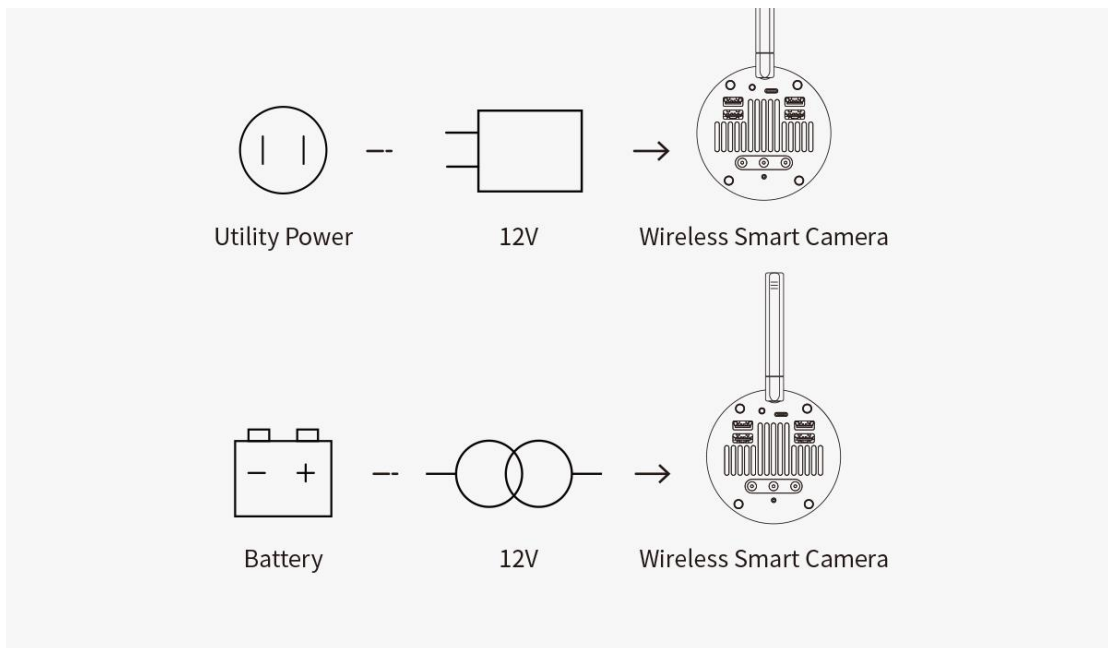

The camera has multiple DC power ports. You can choose any one

as the power input port, while the remaining DC interfaces can be used as power output ports, powering devices such as the dew heater strap or mount.

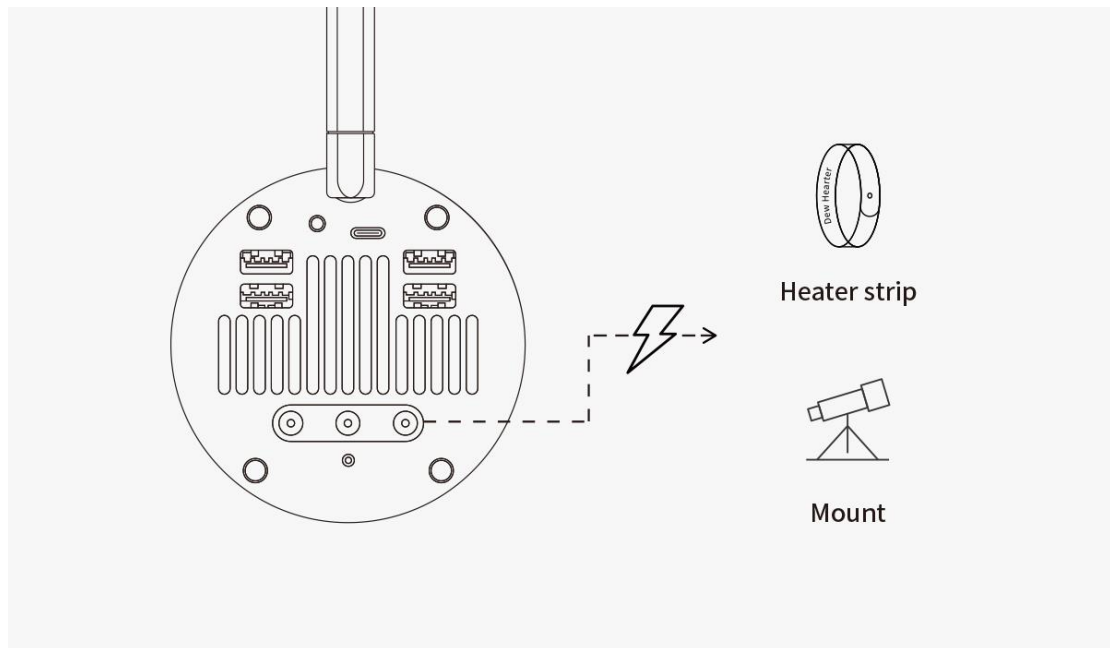

Pay attention to the length of the cables to prevent them from tangling during the mount head's rotation.

6. 3. Network Connection

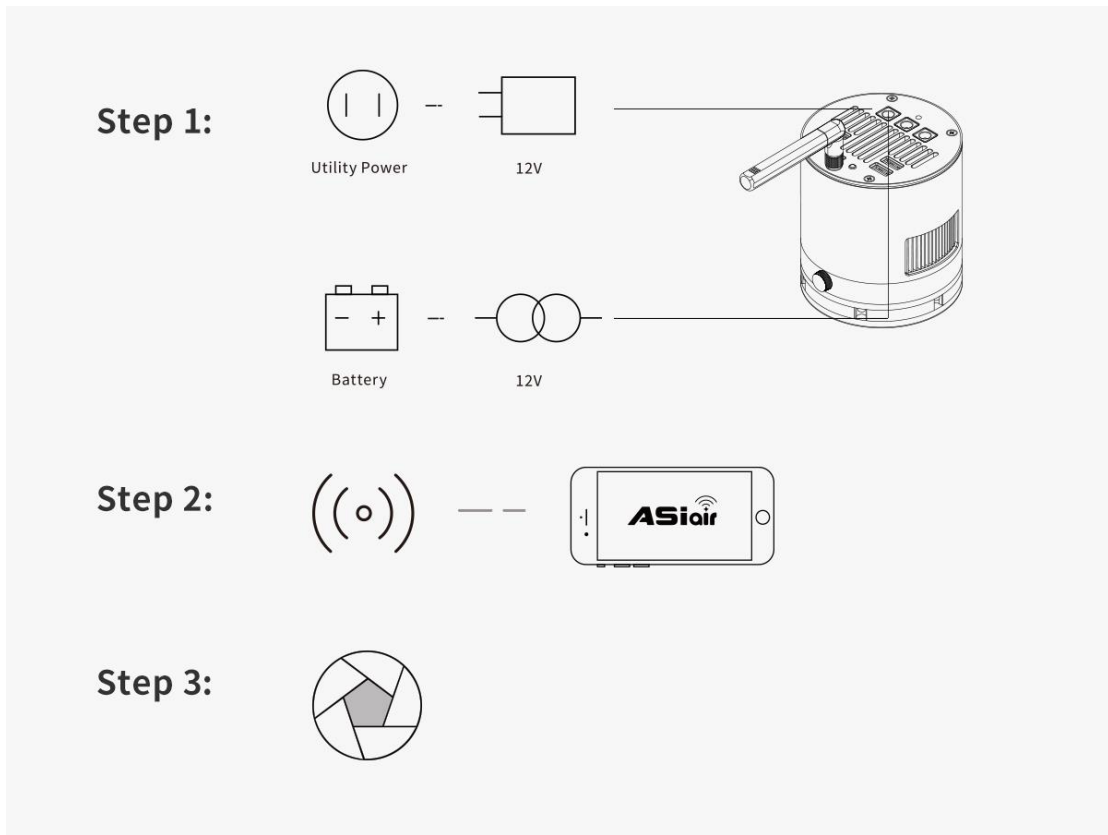

Power the wireless camera with utility power or a portable power source.

Connect your mobile device to the camera's Wi-Fi network. The Wi-Fi name is typically the camera model followed by "AIR_" and the serial number. Enter the initial password: 12345678.

Once the Wi-Fi connection is successful, open the ASI AIR App and follow the prompts to complete device activation (only needed for the first connection).

#For iPad and Tablets (Wi-Fi only models):

These devices cannot access the Internet while connected to the camera's Wi-Fi, so you will need to switch networks twice during the

activation process:

① After entering the App activation page, switch the device network to the Internet, return to the App, and tap "Get authorization code online" as prompted.

② Once the App indicates "Authorization code obtained successfully", switch the device network back to the camera's Wi-Fi, return to the App, and tap "Activate" to complete the process.

The built-in Wi-Fi hotspot of the wireless smart camera theoretically covers a range of up to 20 meters in an unobstructed environment.

6. 4. Mount Connection via Cables

1.RS-232 - USB Conversion



Most equatorial mounts come with a dedicated control system, commonly known as a "hand controller." Examples include ARGO VAVIS, GTOCP series, StarGo, NexStar series, SynScan V3/V4 series, Pulsar2 GoTo, Go2Nova series, Gemini series, AutoStar series, AudioStar series, PMC-8 (requires manual switch to serial mode), and popular DIY options like Electronic FS-2.

To connect these mounts, an RS232-USB cable is used. Alternatively, you can choose an integrated FTDI cable for simpler wiring. For SynScan V5, a USB Type B – Type A printer cable is required. If the connection fails

in the App, please ensure the baud rate is set correctly.

2.Direct USB connection to mount's HC port



With continuous optimizations by mount manufacturers, some equatorial mounts now have the control system built into the mount itself, exposing a direct connection port on the mount body. This simplifies wiring even further. You can connect the mount to the wireless smart camera using a USB Type B – Type A printer cable.

Note: Check the specific documentation of your mount to ensure its compatibility.

3.EQMod: Using EQDir Cable

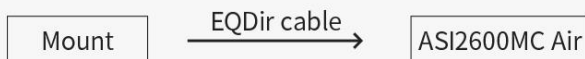

For EQ series mounts, besides using the hand controller, you may also consider a simpler and more stable connection method - Directly connect the mount's HC port (or AUX port) to the wireless smart camera's USB port with an EQDir cable. In the App, select [EQMod Mount] or [EQMod with SkySafari] to proceed.

Mounts with EQMod:

EQ3-2

NEQ3

HEQ3

SkyView Pro EQ

EQ4

EQ5

HEQ5

EQ6

EQ6 Pro

NEQ6

EQ6-R PRO

AZ-EQ5GT

AZ-EQ6GT

EQ8

EQM-35 Pro

AZ-GTi*

M-Uno Fast Reverse Single Fork Arm EQ

Linear Fast Reverse EQ

Vixen GPDX / Vixen SP fitted with Sysncan Upgrade kit (EQ5)

CEM26、GEM28、CEM40、GEM45、HEQ5 PRO、AVX、CGEM II、
CGX、RST-135、RST-135E、EM31、Crux 170HD、Crux 140HD、Mark
III

AM5

HEM27

The default baud rate for EQMod connections is 9600. However,
specific models have different requirements:

- AZEQ5 and EQ6-R PRO: Baud rate is 115200.

- AZ-GTi: Baud rate is 11880 and uses the UDP protocol.

6. 5. Mount Connection via Network

Wi-Fi Connection



With the rise of wireless technology, some manufacturers have started integrating Wi-Fi modules into their mounts or offering external Wi-Fi accessories. Examples include the SynScan Wi-Fi module of the AZ-GTi, as well as the StarFi Wi-Fi Adapter, SkyPortal Wi-Fi Module, StarGo Wi-Fi mode, and PMC-8 Wi-Fi mode.

The principle behind these Wi-Fi connection methods is largely similar. However, since there is no unified standard for Wi-Fi connections yet, detailed instructions for connecting the wireless smart camera to these mounts can be found on the ZWO website. Please refer to the help documentation on using the ASI AIR with the aforementioned mounts.

6. 6. Telescope Connection

Connect the wireless smart camera to the telescope through suitable adapters. You may need to meet the requirements of a 55mm back focus distance.



6.7. Lens Connection

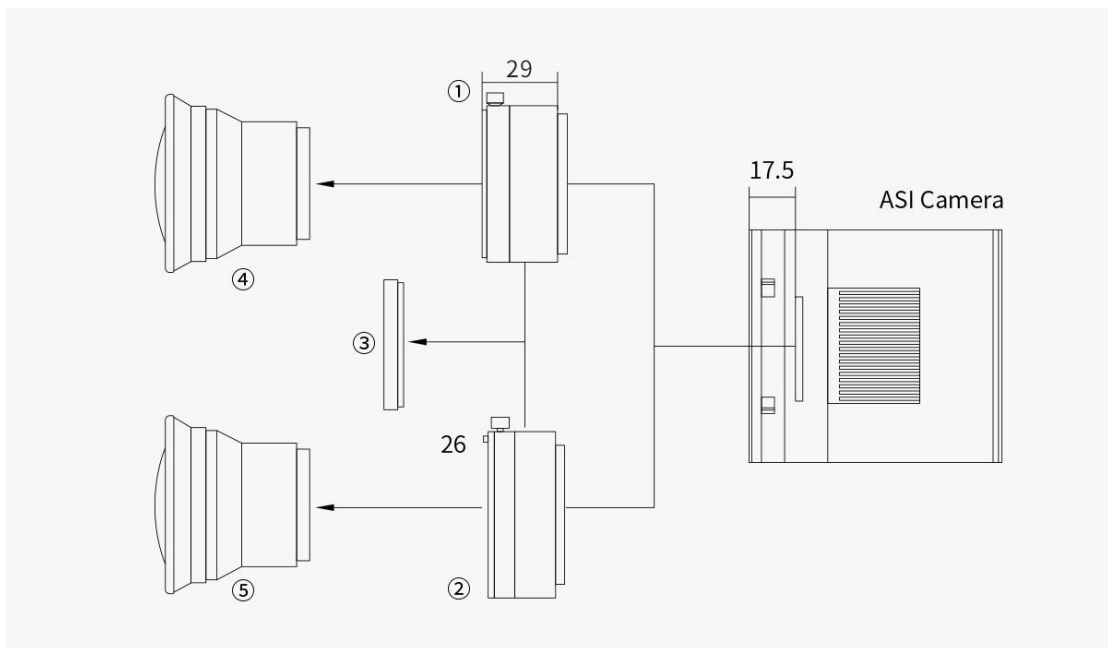

- ① Nikon-T2 adapter
- ② EOS-T2 adapter
- ③ 2" filter (optional)
- ④ Nikon lens
- ⑤ Canon lens

7. Astrophotography with ASIAIR App

This chapter mainly introduces the main functions and usage guide of the ASIAIR App, the mobile supporting the wireless smart camera. Note this workflow is the main way that ZWO officially recommends.

7.1. Interface Overview

7.1.1. Home

Run the ASIAIR App. Hit "ASIAIR" in the bottom icon bar. By hitting "Enter Device", you shall start your imaging project.



7.1.2. Community

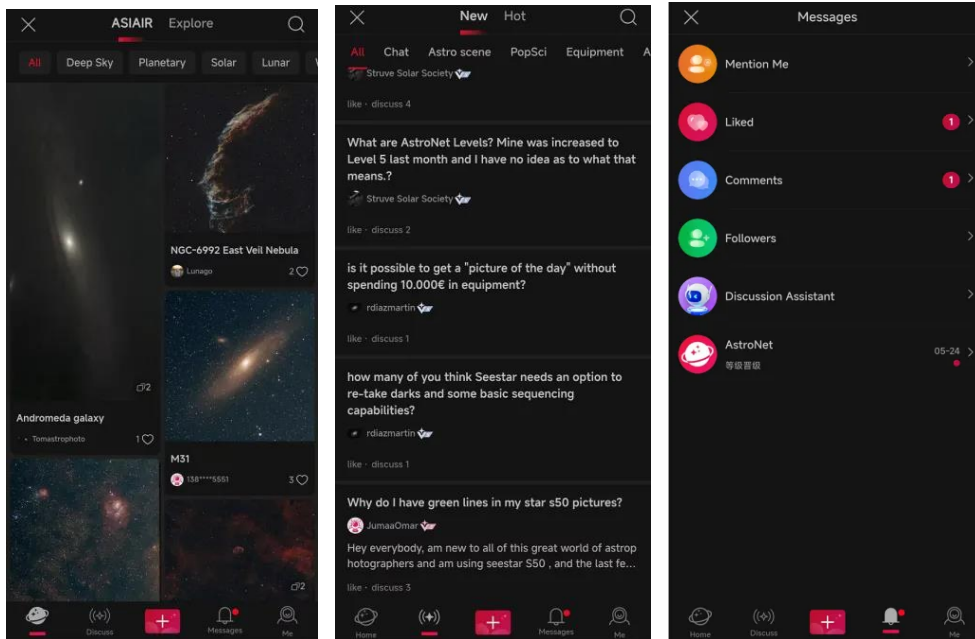

Home: This page showcases a variety of rich photography works, including deep-sky objects, planets, and star fields. The images are presented in a waterfall flow layout, allowing users to browse through numerous photos seamlessly.

Discuss: This page serves as a space where users can ask questions and share their views. Users can see posts from other users, creating an interactive community environment.

Messages: This page allows users to view their social messages on the platform.

7.1.3. Nearby



On the "Nearby" page, you can find nearby stargazing sites and stargazers around you, and also check the light pollution map.

7.1.4. Me

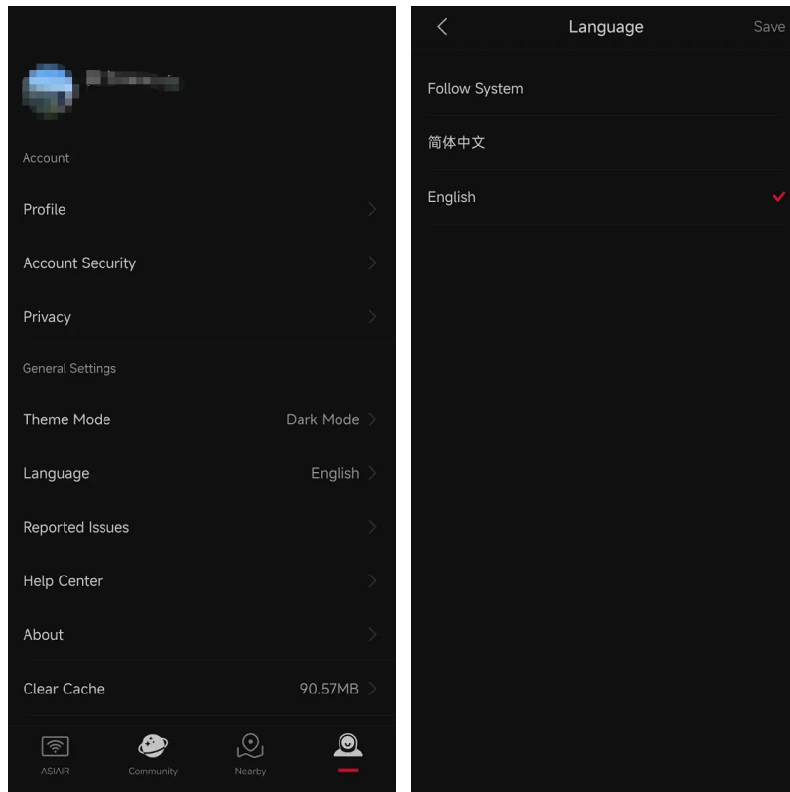

On the "Me" page, you can publish and view your own photography works.

Tap the setting icon to do some basic setting adjustment work. For example, the "Language" option will allow you to change the display language of the App.

7.2. Basic Configuration

7.2.1. Gear Profile

< ASI AIR iPhone Network: 2600AIR_8384195f Connected SN: 8384195F App: 2.2(40.20)

Phone Info

Date/Time 2024-06-06 10:12

Latitude N 31° 15' 49"

Longitude E 120° 42' 55"

Setting Tips

1 Enter 0 if Main Scope Focal Length (FL) is unknown, ASI AIR will auto fill in after plate solve

2 Enter correct FL when using Guide Scope

Mount ZWO AM5/AM3

Main/Guide Scope FL 800 mm 800 mm

Main Camera ASI2600MC Air

Guide Camera ASI220MM Air

Other Devices No EFW No EAF

ENTER

Complete the "Network Connection" setup, then set your gear information here. Once configured, click "Enter" to access the App's main operation page.

Please ensure the latitude and longitude in the "Location Information" match the current geographical coordinates of your wireless smart camera device. If the automatically obtained information is incorrect, you can also manually set it.

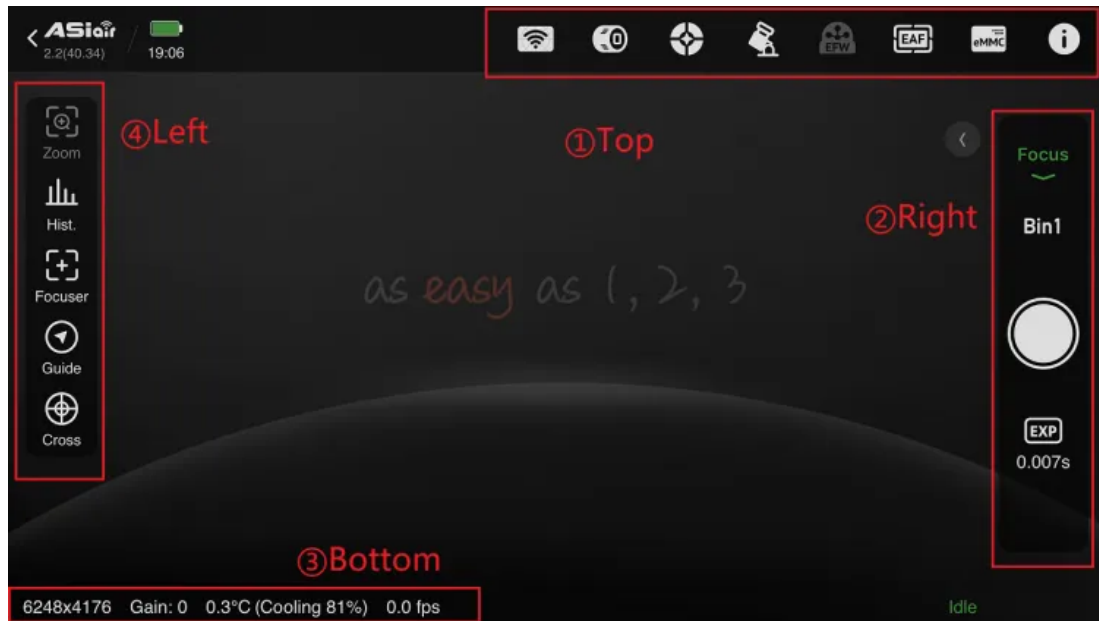

① Top Menu Bar

Tap on any icon to pull up the corresponding settings page. From left to right, the icons represent settings for the Wi-Fi, main camera, guiding, mount, EFW, EAF, eMMC storage, and more information. Icons will be "lit" if the corresponding device is connected and turned on; otherwise, they will be grayed out.

② Right Side

Switch between main functions. Tap "Preview" to switch between focus adjustment, polar alignment, plan, multi-target, live stack, and video mode.

③ Bottom – Information Bar

Displays the working status of the wireless smart camera, including resolution, gain, temperature, cooling power, and other camera information.

④ Left Side

This area shows available tools for the current mode, including histogram, focusing, guiding, plate solving, crosshair, annotation, and star detection. Tap an icon to use or close the corresponding tool.

7.2.2. Wireless Smart Camera

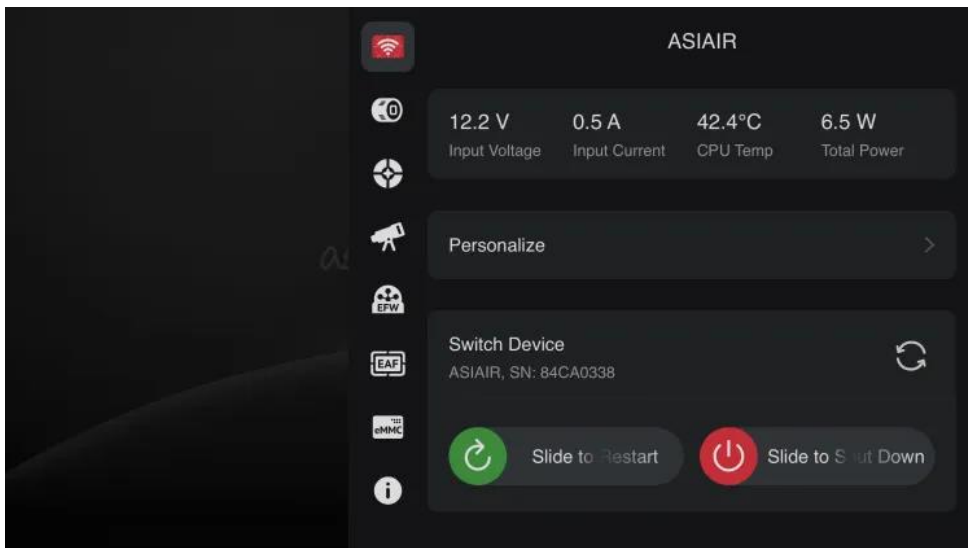
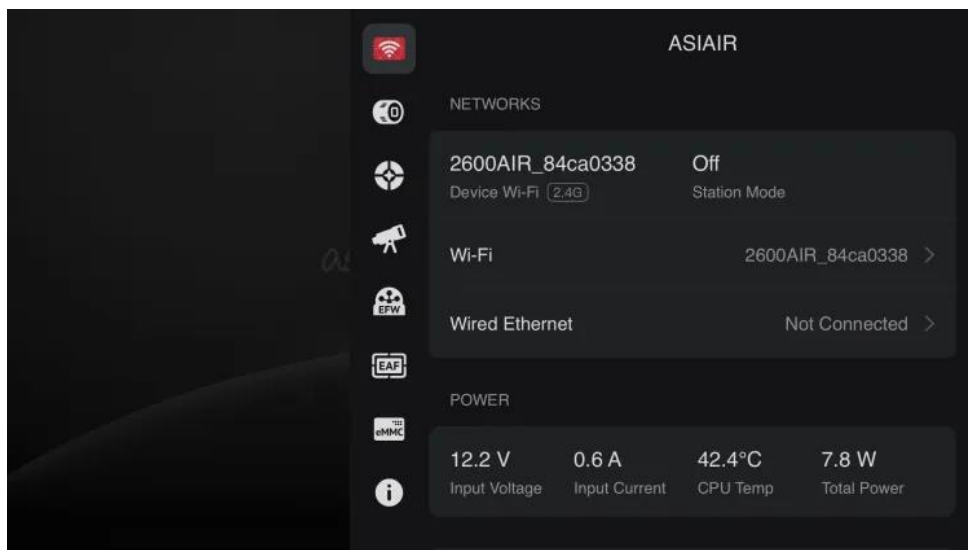

This page contains most of the basic settings related to the wireless smart camera:

Network: Customize the wireless hotspot name and password for the smart camera, switch between 2.4GHz and 5GHz Wi-Fi hotspot bands, and configure Wi-Fi station mode.

Power Monitoring: Real-time display of input voltage, input current, current CPU working temperature, total power, and other information.

Personalize: Adjust voice volume, temperature unit, and other preferences.

Switch Device: Displays the name and SN number of the wireless smart camera. Once the station mode configuration is complete, you can switch between multiple devices within the home LAN.

Restart/Shutdown: For safety considerations, a soft shutdown operation is provided. You can choose the "Slide to Restart" or "Slide to Shut Down" function. Restart will also exit the app. Please wait patiently for 5-10 seconds before disconnecting the device from the power supply.

Wi-Fi Station Mode: After configuring according to the App's prompts, you can connect the ASIAIR device to the home LAN. By doing that, you are now able to control your gear and photograph targets anywhere in your home, breaking the distance limitation of AP connection! Also, you will still have access to the network on your phone or other mobile devices while ASIAIR doing astrophotography for you.

7.2.3. Main Camera

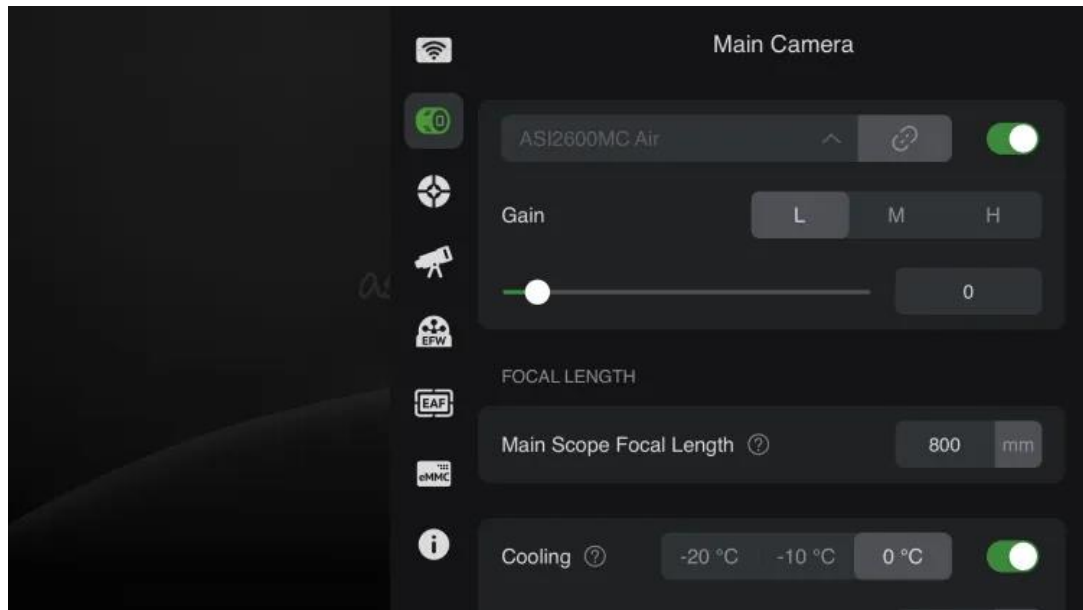

Select the main camera and turn it on. When switching cameras, please turn the switch off first, then turn it on after switching cameras.

Then set gain and fill in the focal length of your telescope.

Gain: It is the camera's amplification of the signal. Generally, the medium gain is selected. If you find that the image in the camera is not bright enough, you can consider increasing the gain level or manually dragging the progress bar to get a larger gain.

If the camera cooling function is used, the cooling function will be turned on by default after opening the App, and the target cooling temperature can be set.

In addition, this camera also has a glass window heating and defogging function.

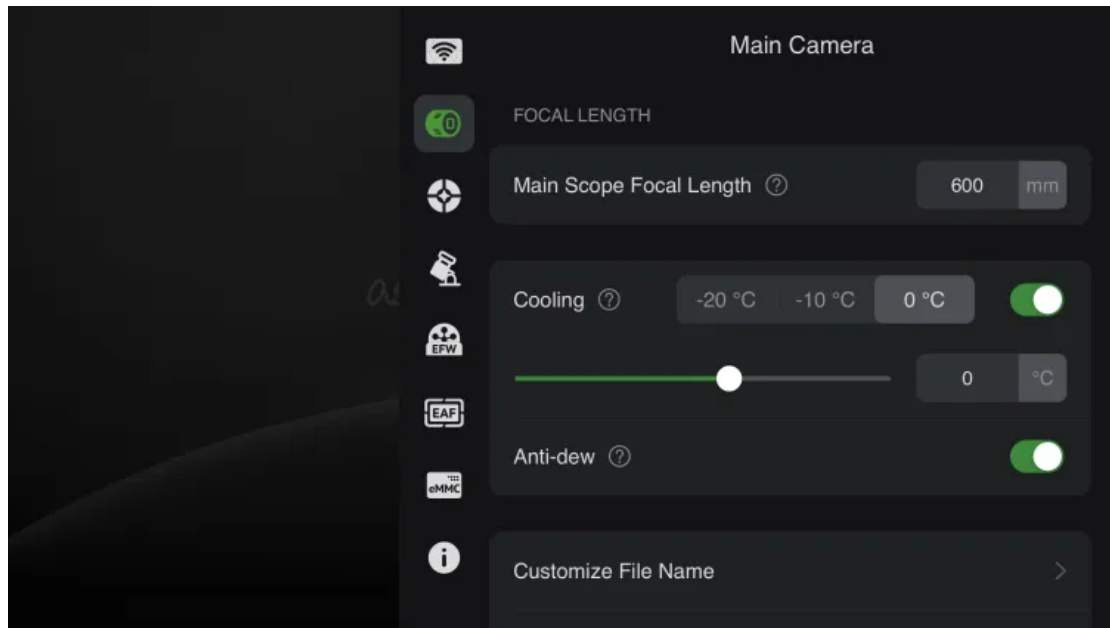

Customize File Name: You can customize the file name of the images you captured. The addible options include camera model, gain, temperature, etc.

Advanced Settings: Advanced settings include automatic white balance, Mono Bin, continuous preview, automatic cooling after connecting to the camera, etc.

7.2.4. Guiding

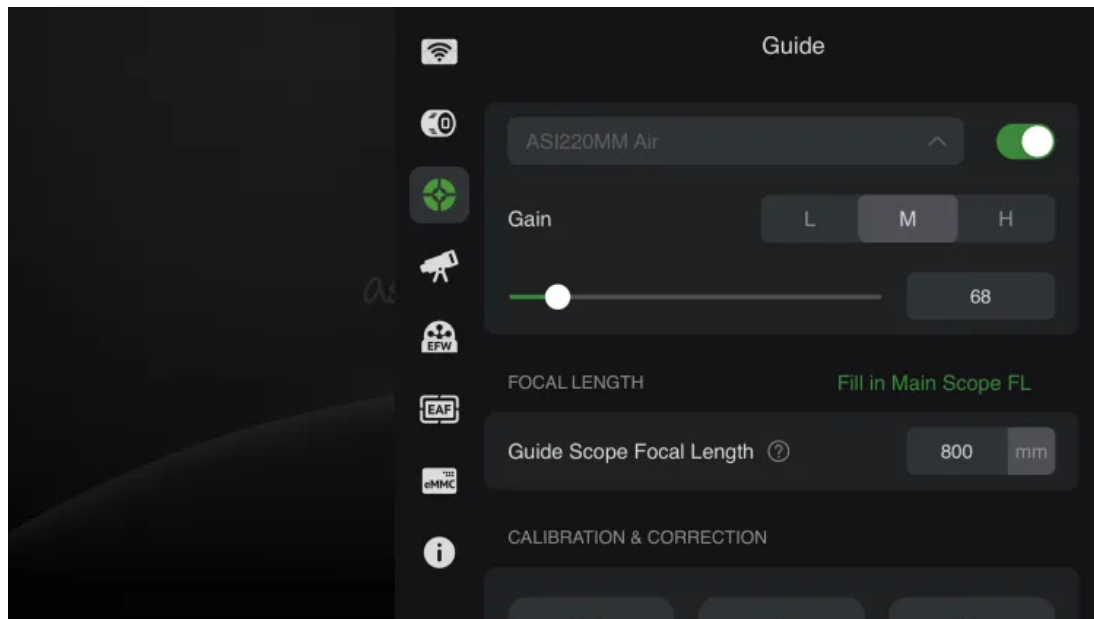

Select and turn on the guide camera here. It is recommended to select "High" for gain. In wireless smart camera products, please be sure to fill in the focal length of the guide camera accurately.

Gain: It is the camera's amplification of the signal. Generally, the guide camera needs to obtain enough bright stars in a relatively short time, so it is recommended to choose "High" here. If you find that the stars in the guide camera are not bright enough or too few in number, you can consider manually set a larger gain.

Focal Length: In the wireless smart camera, the focal length of the guide camera is the focal length of the main camera. You can also click "Fill in Main Scope FL" to complete the automatic filling.

#Warm reminder: before starting astrophotography at night, please adjust the guide camera to infinity focus. You can adjust it during the day with the help of extremely distant landscape objects.

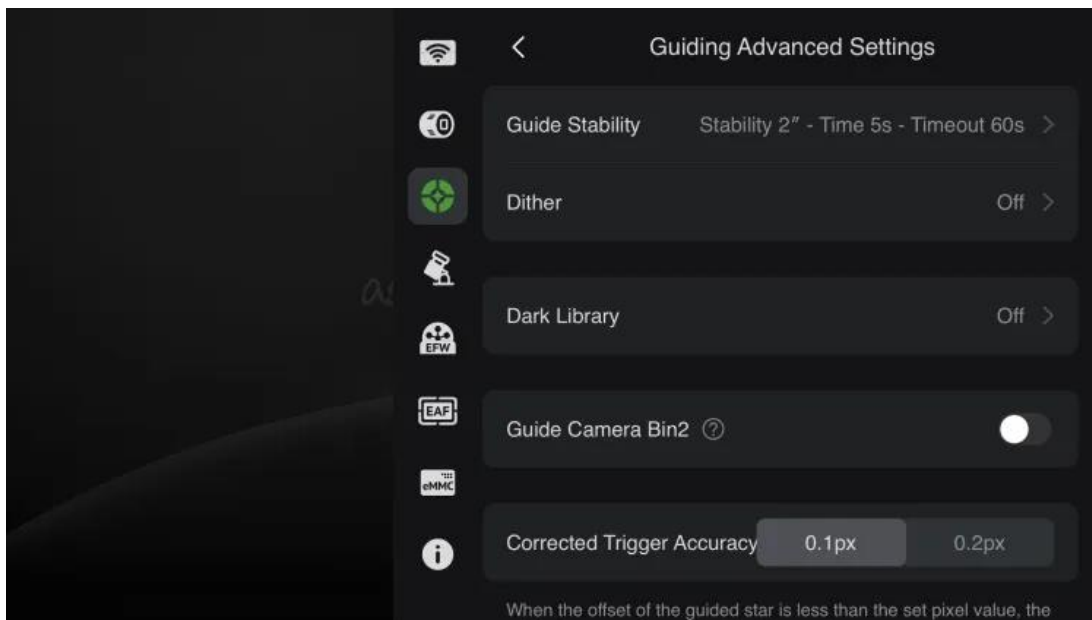
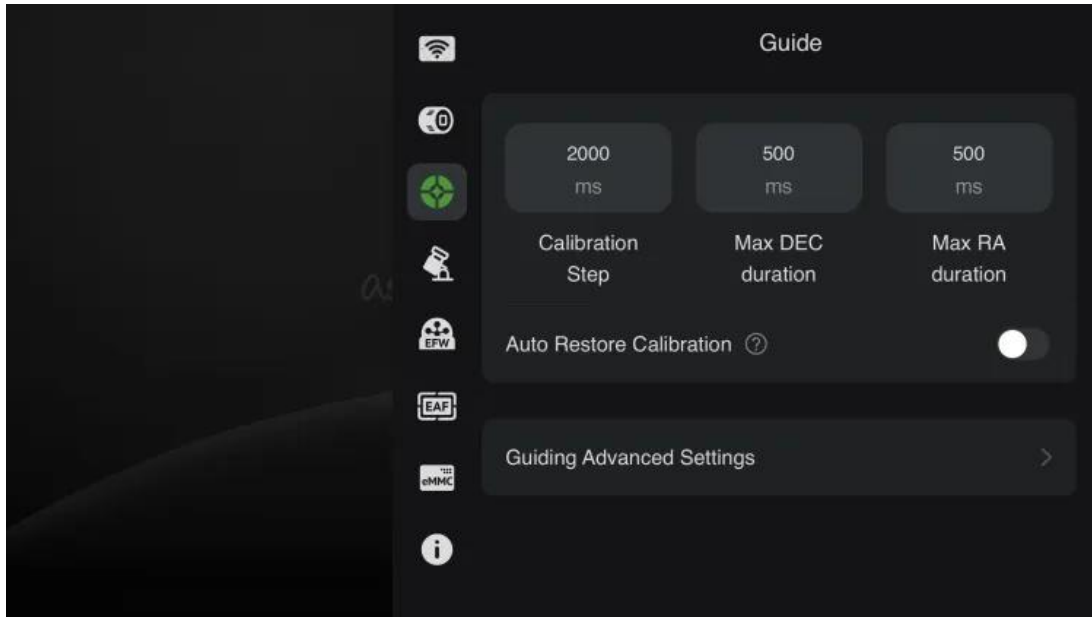

Calibration settings:

Calibration Step: It is a parameter related to guide calibration. Keep the default value of 2000 milliseconds.

Max DEC duration: It is recommended to keep the default value or adjust it to less than the exposure time of the guide camera.

Max RA duration: It is recommended to keep the default value or adjust it to less than the exposure time of the guide camera.

Auto Restore Calibration: If your gear has not been moved or disassembled since your last imaging session, you can consider choosing this option.

Guiding:

Guide camera Bin2: This function is generally not used. It can be turned on when the star is not visible.

"Guiding Stability" and "Dither" are generally used at the default values. You can turn on dither according to your needs. If you are just starting to use ASIAIR, it is recommended to keep it off.

Darks Library: You can use this function to calibrate guiding images with dark frames. Generally, the performance of current guiding cameras is strong enough, so it can be ignored under normal circumstances.

7.2.5. Mount

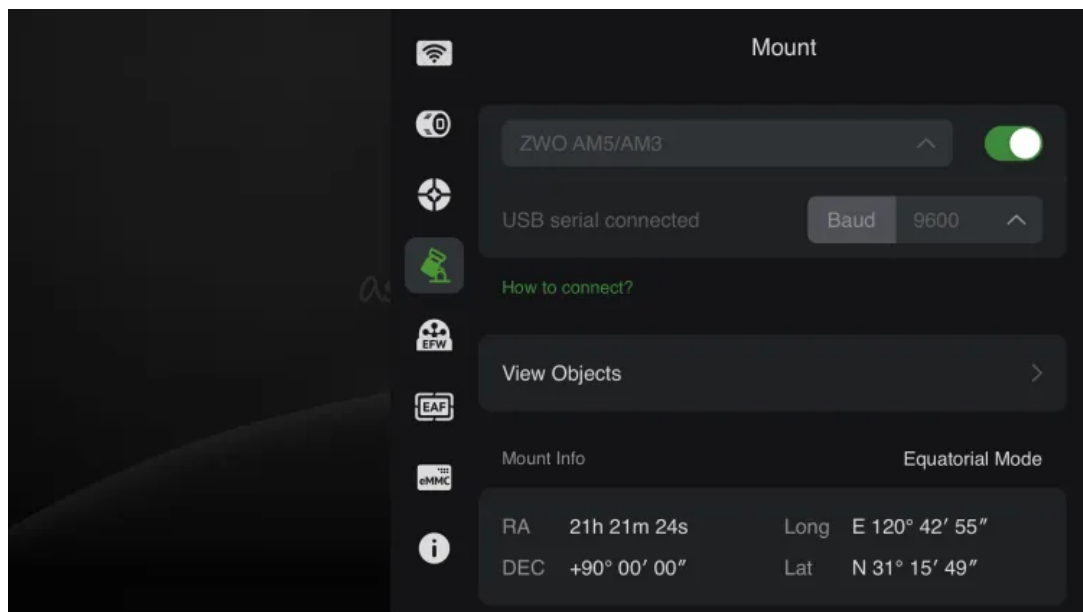

Select the corresponding mount model or connection method and toggle the switch to connect. For specific mount connection methods, refer to the "Connection Methods" section in this document.

Mount Info: This records the mount's location, time information, and the current pointing position (usually defaults to the mount's home position). You can use your phone's built-in GPS to determine your location, which is reflected under "Mount Info" as "Location Info" to set your mount's correct position.

If the mount's geographical location and time information are inaccurate, you can synchronize the phone's GPS data with the mount. Tap "Sync to Mount" to transfer the location information from your phone to the mount. Similarly, the time zone and time information under "Mount Information" are also obtained from your phone.

If the Right Ascension (RA) and Declination (Dec) display as 00° 00'00", try restarting the mount and reconnecting.

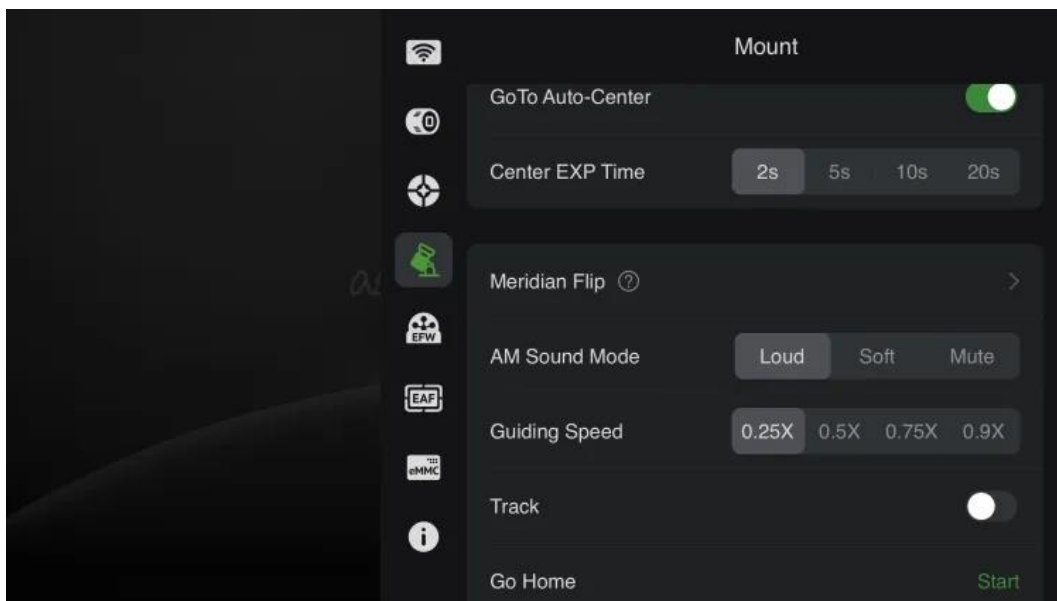

GoTo Auto-Center: It is recommended to enable this function.

Center EXP Time: The default is 2 seconds.

Meridian Flip: You can start with the default settings or make some adjustments according to your preferences.

Guiding Speed: Some mounts allow this setting. Guiding rate refers

to the speed multiplier for the mount's correction movements during guiding, with a default of 0.5X.

Tracking: It is recommended to keep tracking enabled when starting to capture images.

Tracking Speed: This is the rate at which the mount tracks celestial objects, with the default being sidereal rate.

Go Home: This function returns the mount to its initial home position. We recommend performing a home position operation at the beginning of each session and before shutting down the setup after completing your imaging session.

7.2.6. Filter Wheel

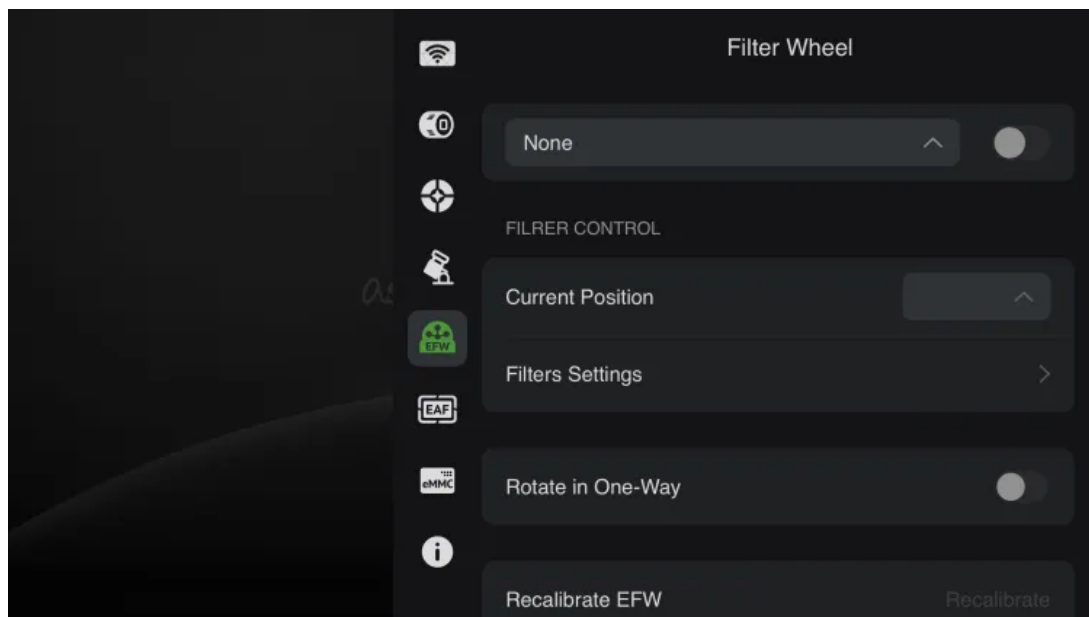

After connecting the filter wheel, you can configure it as follows. For color cameras, the filter wheel is an optional device.

Current Position: Manually select different numbers for filters. The filter wheel will rotate to the corresponding filter position during your imaging session.

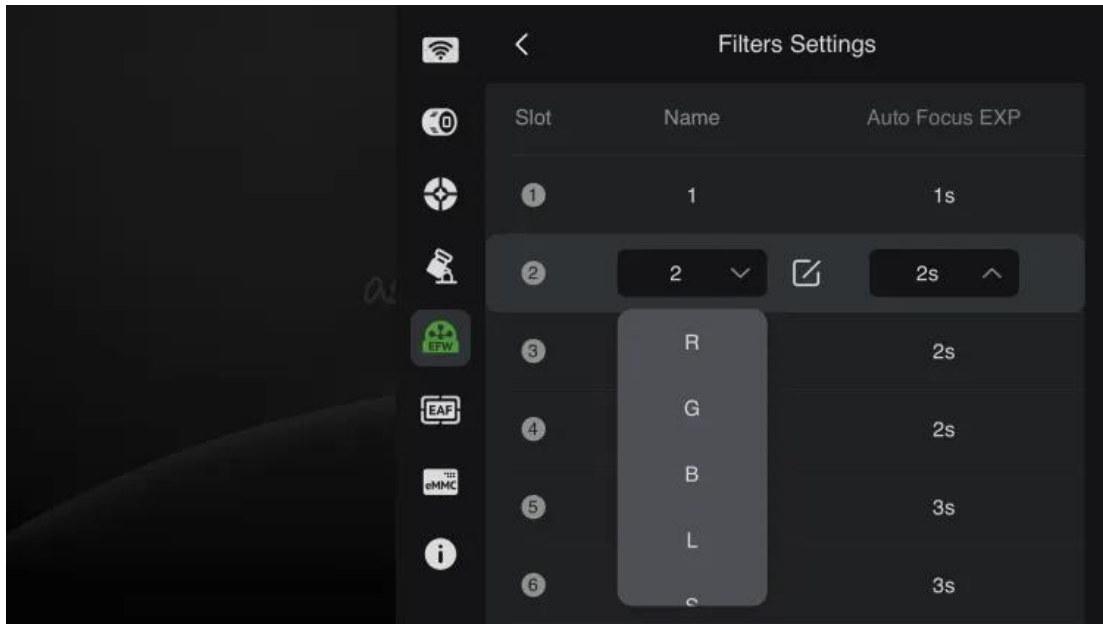

Filters: Set the name and autofocus exposure time for each filter position. You can choose names based on the filters you use or customize them.

Rotate in One-way: When this feature is enabled, the filter wheel can only rotate clockwise to switch filters.

Recalibrate EFW: If the filter wheel positions are not accurate, click "Realibration" to reset the filter wheel's positions.

7.2.7. EAF

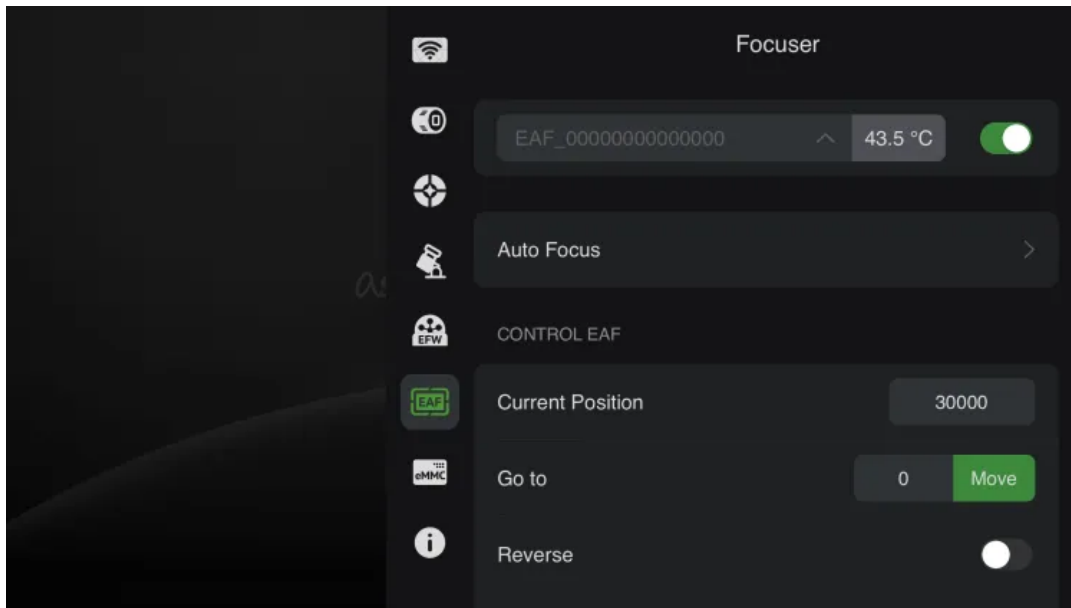

Once you have connected the EAF, simply tap to connect and proceed with various parameter settings. For detailed settings, please refer to the ZWO EAF manual.

Current Position: Displays the current focus position of the EAF. You can redefine the current position by entering a new value in the input box.

Go To: Controls the EAF to move to a specified position. Enter the target position in the input box on the right and tap "Go To" to initiate.

Reverse: Changes the EAF movement direction to the opposite direction.

Beep: Provides an audible alert when the movement is complete or if it fails. One beep indicates completion, and two beeps indicate failure.

*It is recommended to enable the beep function.

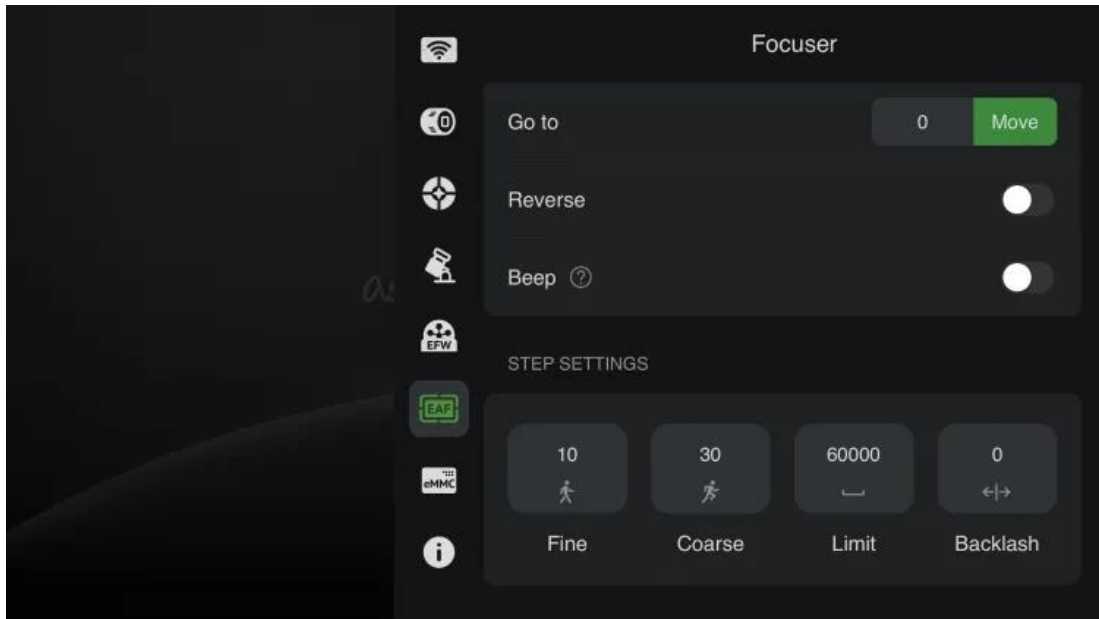

Step Settings: Configure the step count for fine-tuning and coarse adjustments. The travel limit refers to the maximum travel position that the EAF can move to.

Backlash: Set the number of additional steps to move when the EAF changes direction to compensate for backlash.

7.2.8. Storage

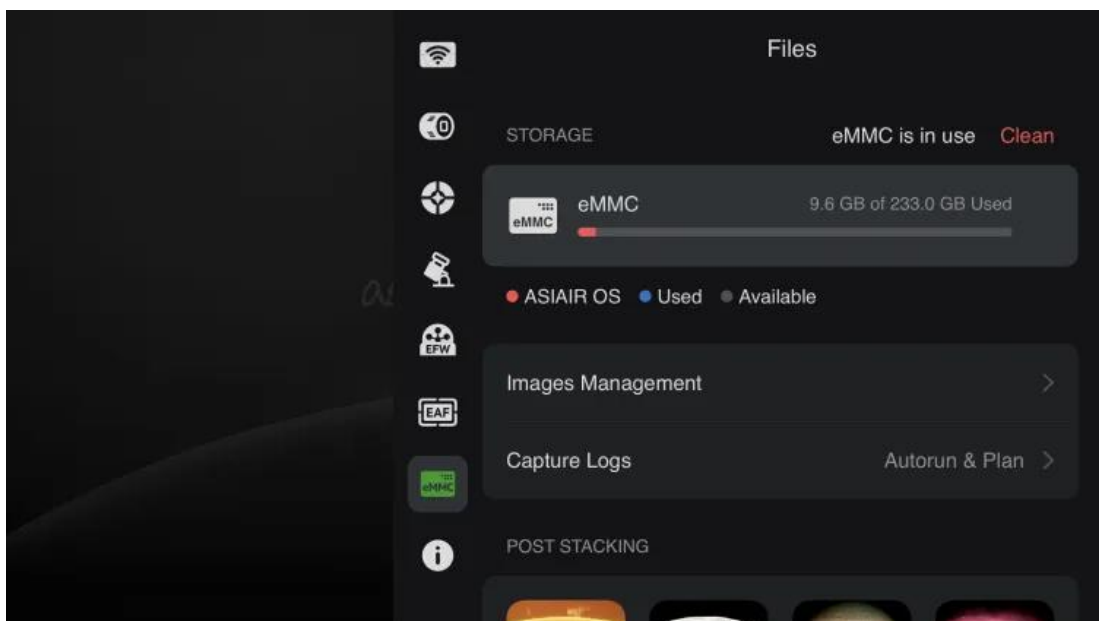

Storage: Displays the storage space and usage status of the wireless smart camera. The camera has built-in eMMC storage and also supports external USB storage devices.

Image Management: Allows for categorizing images and provides options to preview, export, or delete stored images.

Capture Logs: View imaging logs from autorun and plan mode.

Post Stacking: Used to stack videos that have been captured to achieve higher signal-to-noise ratios and clearer images.

7.2.9. About

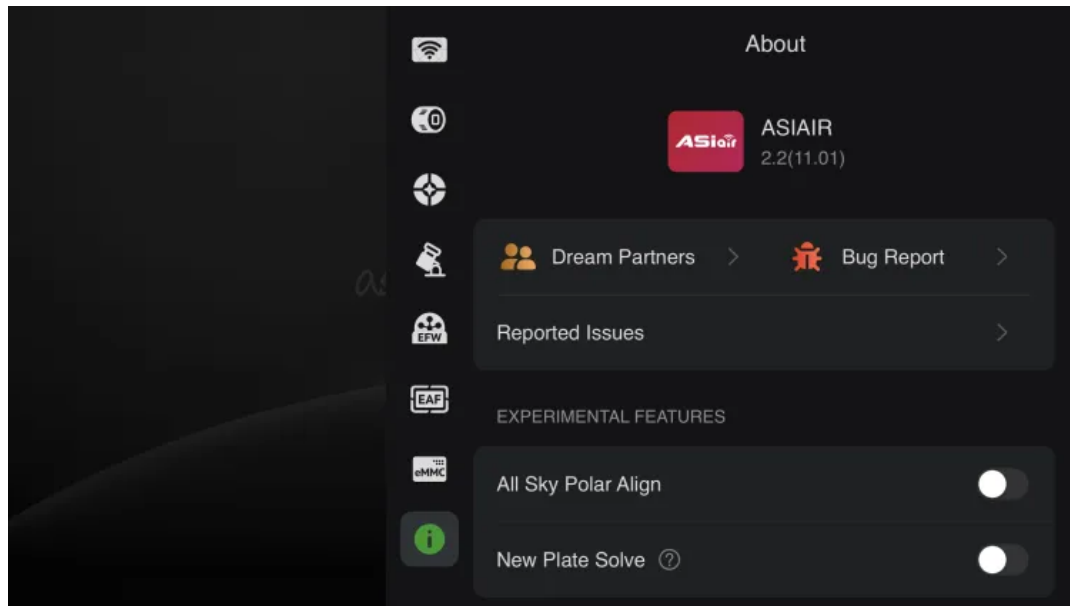

ASI AIR 2.2(11.01): "2.2" is the app version number, "11.01" is the firmware version number.

Bug Report: Report any issues encountered during use.

Reported Issues: View previously reported issues.

Experimental Features: Contains features currently in the testing phase. Use experimental features with caution as they may not be stable.

All Sky Polar Align: Supports polar alignment anywhere in the sky without needing to point the telescope near the North/South celestial pole.

New Plate Solve: Optimized for situations with fewer star points and higher sky quality, advantageous in dark areas or when using narrowband filters.

Reser Firmware: This function helps revert your device to a previous firmware version.

7.3. Imaging Guide

(Example: FF80+ASI2600MC Air + EAF + ZWO Mount)

One of ASIAIR's missions is to simplify the complex process of astrophotography. To help you quickly experience its ease of use, let's quickly go through the general DSO imaging process (assuming the equipment setup is complete and excluding post-processing):

1. Telescope focusing (main scope, guide scope)
2. Polar alignment
3. Target selection and GoTo
4. Preview and framing
5. Guiding
6. Plan
7. Multi-target imaging

7.3.1. Telescope Focusing

- ① Open the ASIAIR App, select "Main Camera" in the top device settings area, and connect the main camera. Also, connect the EAF.
- ② Switch to the "Focus" mode in the right operation area, tap the "Start" button to view the real-time refreshed image; manually adjust the focus seat until the star points become clearer.

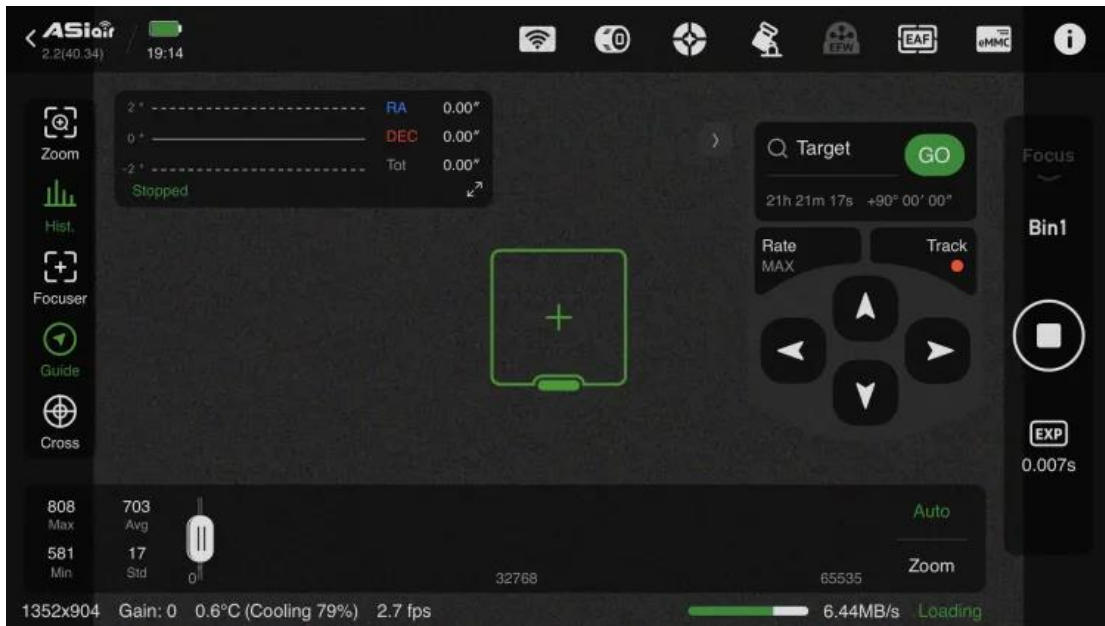

- ③ Drag the green box to select a bright star, tap the "Zoom" button on the left to see the details. Complete focusing based on the principle that the smaller the HFD value under Bin1, the better (you can gradually adjust from the MAX Bin to Bin1). After rough focusing, you can click "AF" to enter automatic fine focusing.



- ④ Guiding Sensor Focusing

In the top device settings area, select "Main Camera" set the

guide camera as the main camera, and connect it. If the guide camera cannot be selected, first disable the current guide camera in the guide camera settings page before continuing.

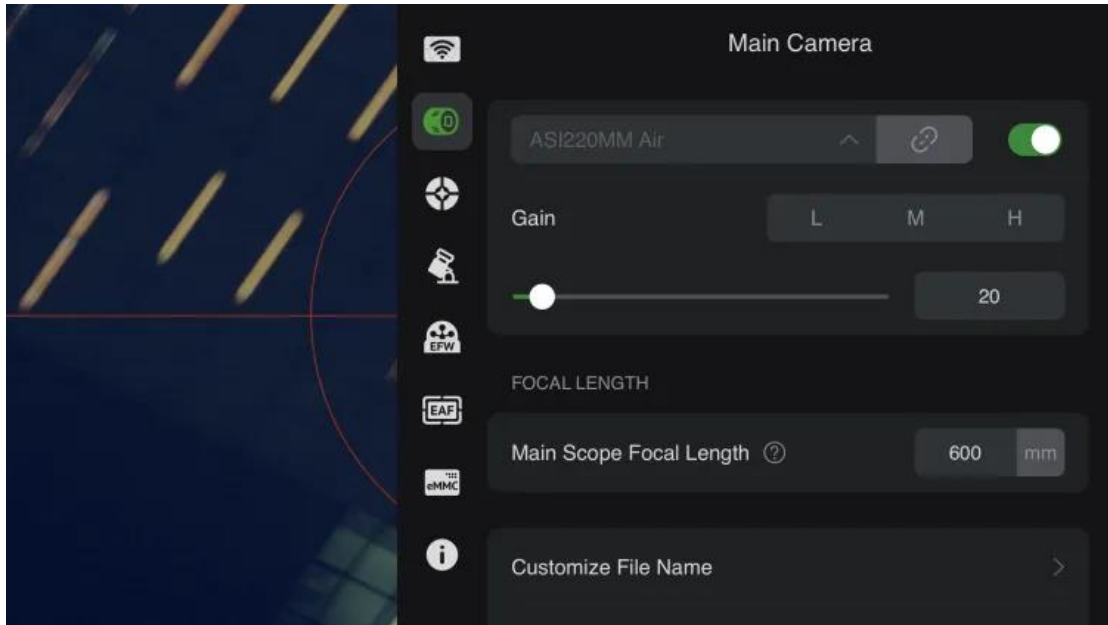

- ⑤ Switch to the "Focus" mode in the right operation area, tap the "Start" button, and manually adjust the focus knob of the wireless smart camera while viewing the real-time refreshed image until the star become clearer.

After focusing the guide sensor, switch the main camera back to the main sensor of the wireless smart camera.

7.3.2. Polar Alignment

Preparation work to do:

- It is recommended to point the telescope (in the mount's zero position) towards the due North/South direction and roughly adjust the mount's latitude angle to equal the local latitude.

- Ensure the mount is properly connected to the wireless smart camera.
- Ensure there are no obstructions in the direction the telescope is pointing. In "Preview" mode, take a picture to ensure the plate solve function works correctly.

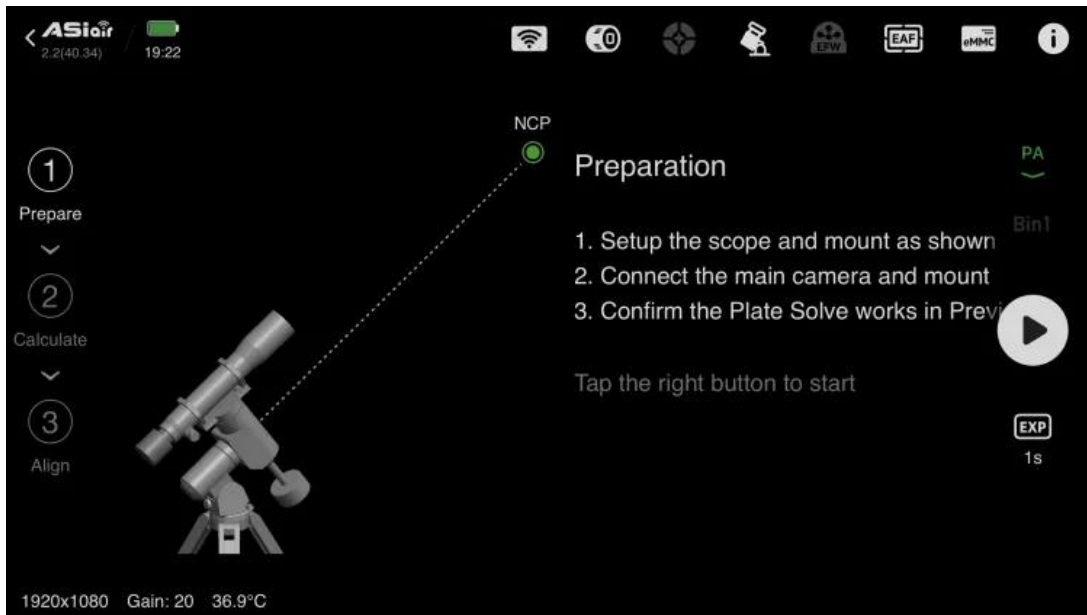

Polar Deviation Calculation:

Tap the button in the right operation area to start the polar alignment process. The mount will take an image at the current position and plate solve it, then automatically rotate about 60 degrees to take another image and solve it. The polar deviation is calculated based on the results of these two different images at different positions.

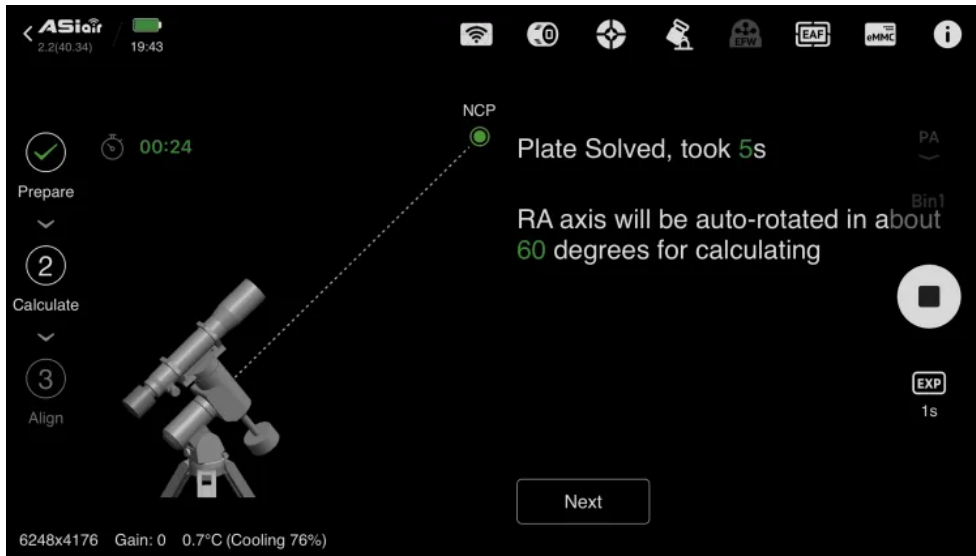

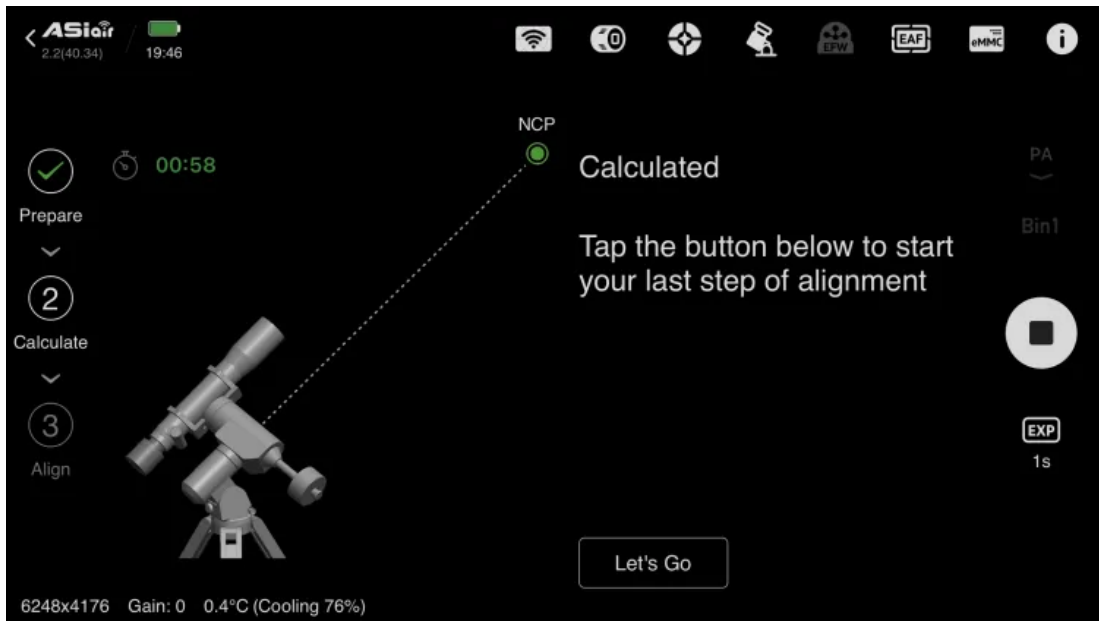

Mount Adjustment

After successfully calculating the polar deviation, tap "Let's Go" to enter the mount calibration page. Manually adjust the mount's altitude and azimuth angles based on the calculated offset values to align the mount's RA axis with the celestial pole.



Adjust the mount according to the green numbers on the right side (loosen the mount's azimuth lock screws and latitude adjustment knobs

before adjusting). Check "Auto Refresh" in the lower right corner to refresh the mount's deviation values in real time during adjustment.

Adjust the mount's azimuth and latitude as follows (refer to your mount's manual for specific adjustment methods):

Left Arrow: Loosen the left azimuth adjustment knob, tighten the right azimuth adjustment knob.

Right Arrow: Loosen the right azimuth adjustment knob, tighten the left azimuth adjustment knob.

Up Arrow: Turn the altitude adjustment knob clockwise.

Down Arrow: Turn the altitude adjustment knob counterclockwise.

A total error within 5' (arc minutes) is acceptable, and the smaller, the better.



After the adjustment is completed, please tighten the azimuth lock screw and latitude adjustment knob in time. Tap Finish to obtain the ranking data.

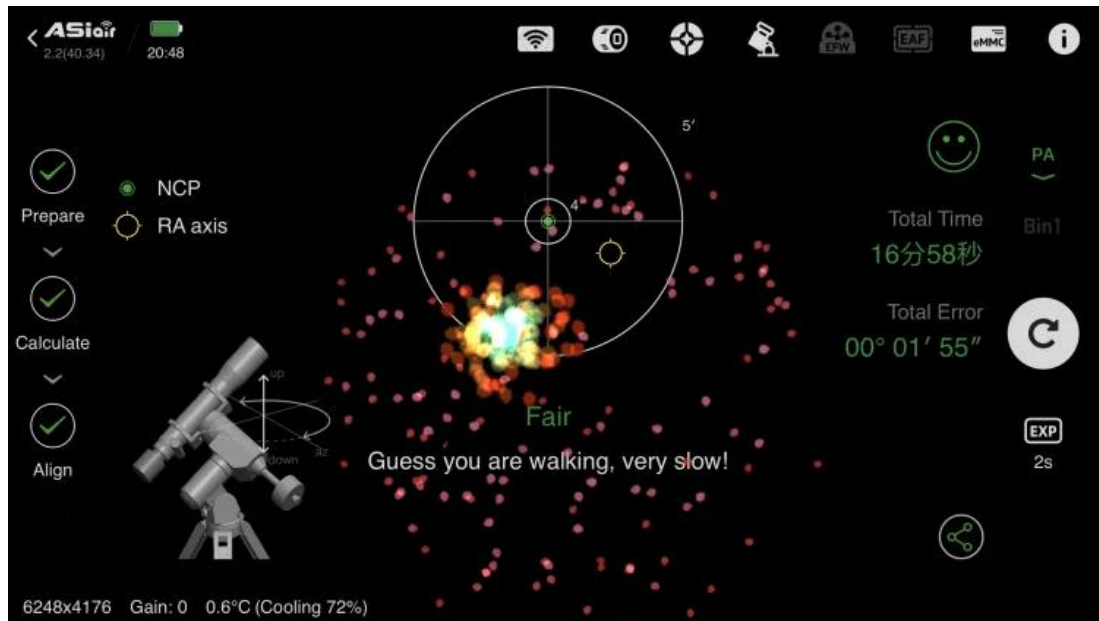

After polar alignment, in order to prevent the tail of the telescope from interfering with the tripod during GoTo, it is recommended to return the mount's zero position first.

7.3.3. GoTo

① After completing the polar alignment procedure, switch to "Preview" mode. Tap the search box on the mount control panel to enter the object list. From the "Tonight's Best" list, select a target with a suitable altitude angle for imaging.



② After selecting the target, you will return to the preview interface. Tap "GoTo", and the mount will slew to this target.

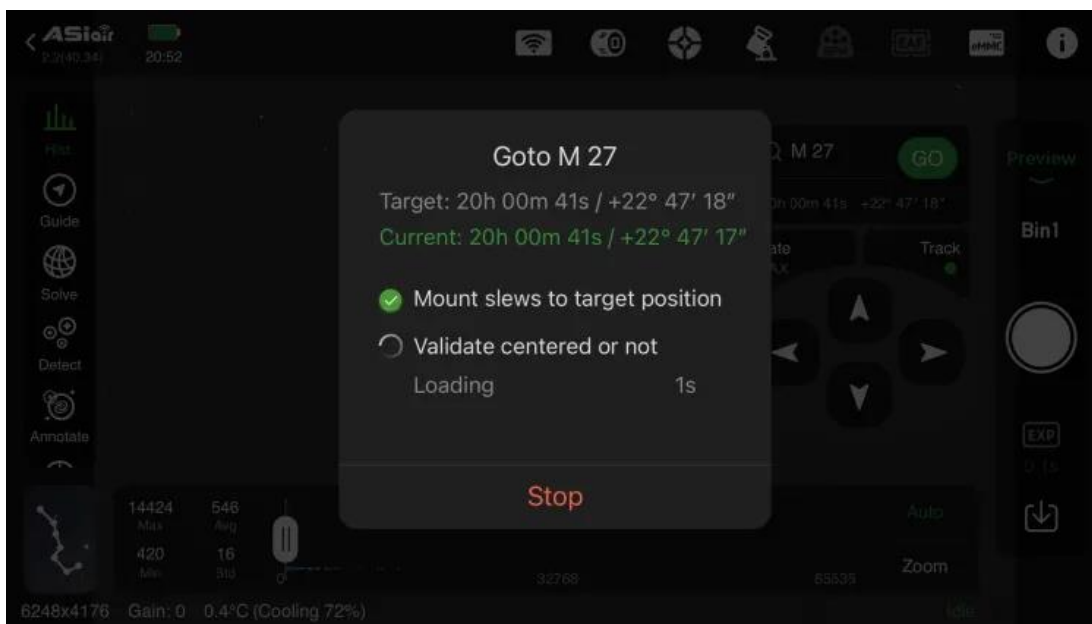

③ By default, the target will be automatically centered in this step.



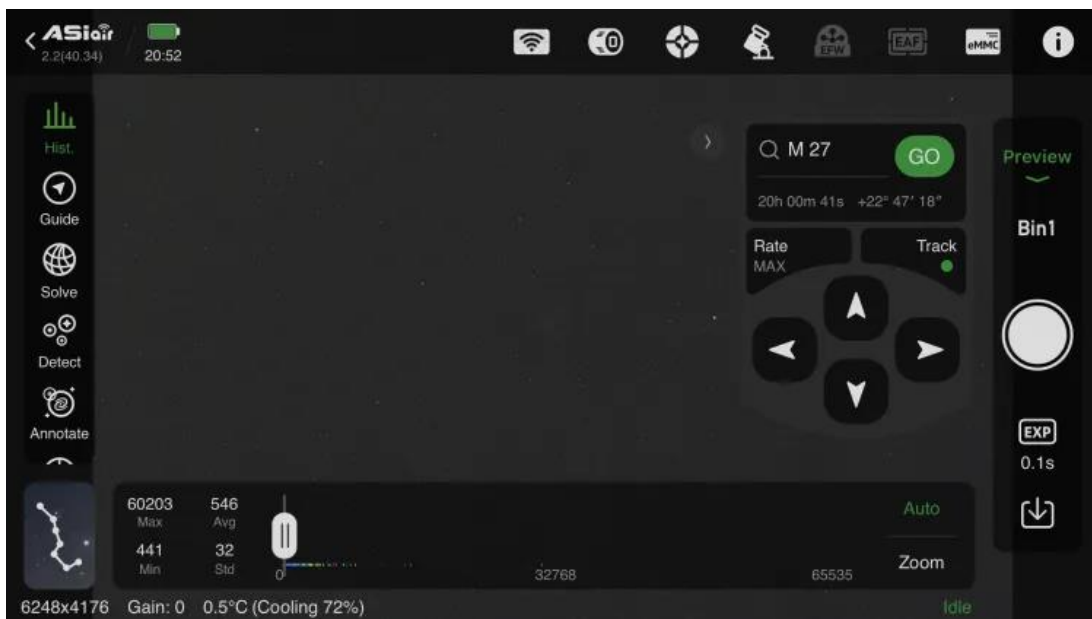

7.3.4. Preview and Composition

After the plate solving and object centering are completed, click the capture button on the right navigation bar to get a short-exposure preview image of the target. You can analyze this preview image to complete composition.

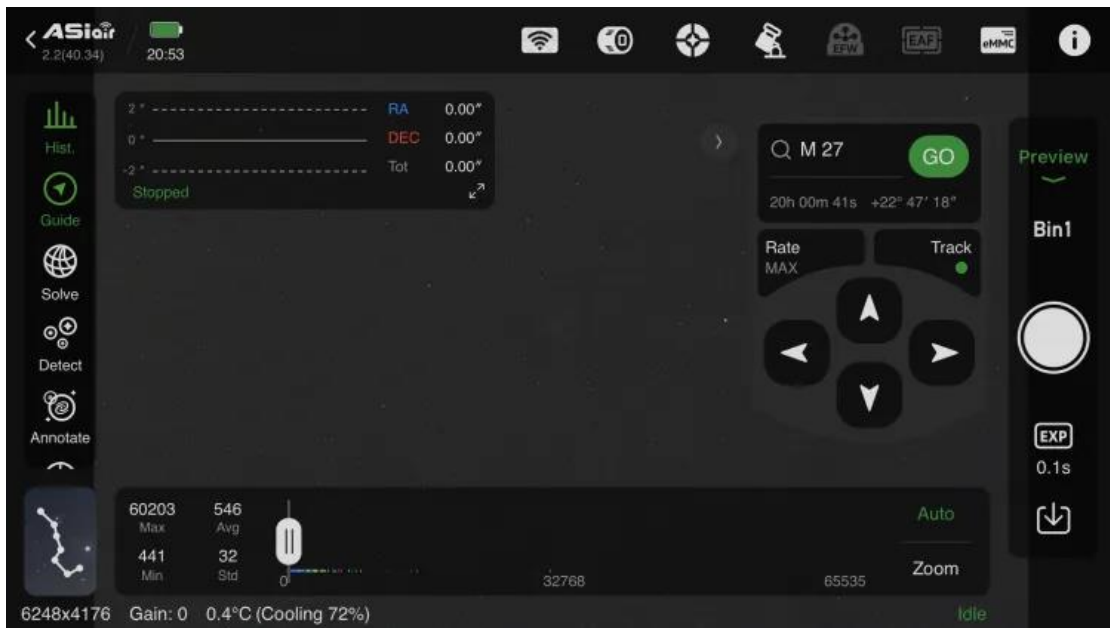

7.3.5. Start Guiding



Tap the  "Guiding" icon to bring up a floating window displaying simplified guiding information. The floating window will display "Stopped". Tap anywhere on the floating window to enter the guiding interface.



Tap the "EXP" icon to select the appropriate exposure time from 0.001 seconds to 5 seconds. Choose an exposure time (recommended

1-2 seconds), and then tap the  button. Real-time images captured by the guide sensor will be displayed based on the selected exposure time.



Tap  to start calibration. Before calibration, you can manually select a star for guiding (Single-star guiding for manual workflow). Do not select the brightest star; usually, a medium-brightness star in the image is enough. You can also tap the button directly, and the ASIair App will automatically select a suitable star for the calibration process (multi-star guiding for automatic workflow). After calibration, guiding will begin.



 The guiding calibration data can be displayed graphically, showing the star movement trajectory formed by the guiding pulses sent by the ASI AIR App during calibration. The blue and red lines represent the RA and Dec guiding rate directions, respectively, and they should generally be roughly perpendicular.



We can tap  to check the guiding status. The red and blue lines are drawn incrementally on the graph, indicating the guiding status. For example, in the displayed interface, the bottom left shows "0.2 fps",

indicating the update frequency of the guiding graph. The "X:50" button on the left side of the graph indicates that the graph can show up to 50 guiding results simultaneously. You can switch "X:50" to "X:100" or "X:200". In the guiding interface, the left side has the guiding curve switch button, and the right side has the guiding settings and start button.

The blue represents the RA axis, the red represents the DEC axis, and the total tracking error RMS value for both axes is 17.48 arcseconds.

"RA Aggr", "DEC Aggr", "DEC Mode" for the ZWO ASIMount can be set to the default values of "70%", "100%", and "Auto". However, you can also try adjusting "RA Aggr" and "Dec Aggr" lower during actual guiding.



Tap this button to stop guiding.

Keep the guiding settings above the guiding curve at default. If the guiding curve fluctuates significantly, you can tap the area after the correction line to display the correction signals to help troubleshoot guiding issues. At the start of guiding, the guiding curve and error statistics might not be accurate. Wait patiently for 10-20 frames, then tap the "Clear" button in the lower left corner of the curve graph before checking again.

7.3.6. Live Stack

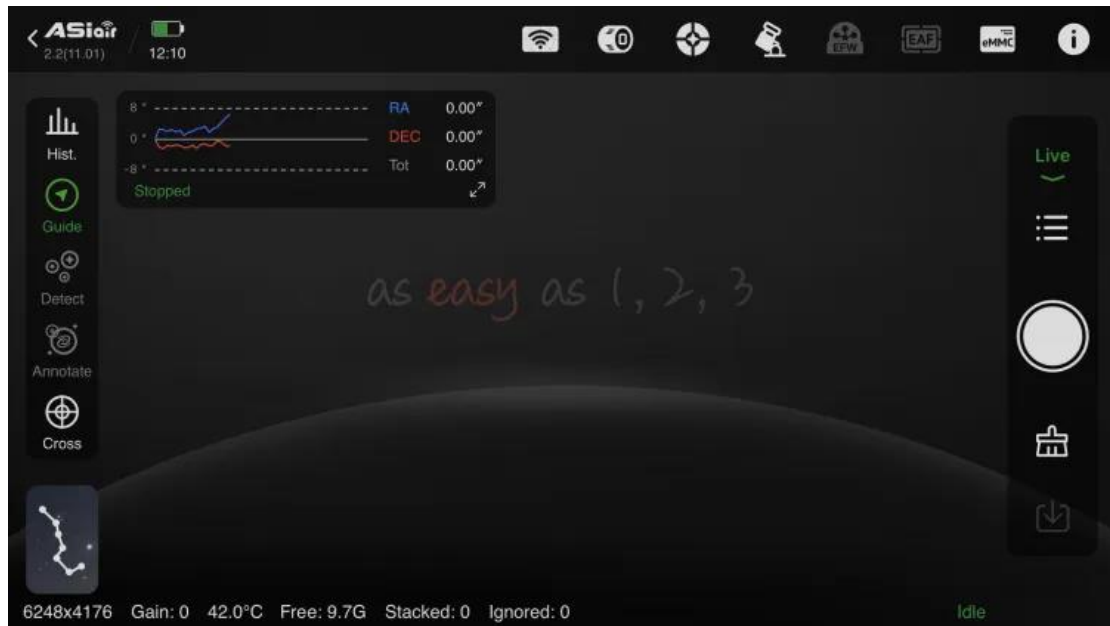

You can perform live stack directly in the ASI AIR App.

Step 1: Switch to "Preview" mode, select the target you want to capture, GoTo the target, and take an exposure to adjust imaging and composition.

Step 2: Switch the App to "Live stack" mode. In the settings, choose the frames you want to stack. It's recommended to stack dark frames, flat frames, and bias frames first. And then when stacking light frames, take advantage of the dark, flat, and bias frames to achieve higher-quality images.

Step 3: During the stacking process, avoid changing the image size. If you change the image size, you will need to clear the previous image data and start stacking again.

7.3.7. Autorun

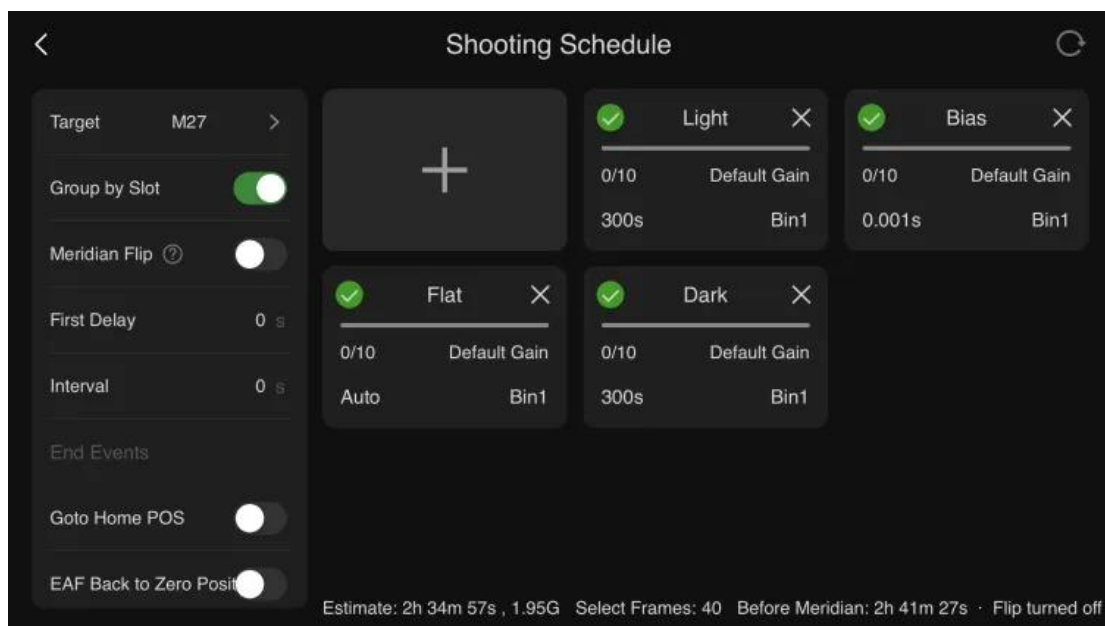
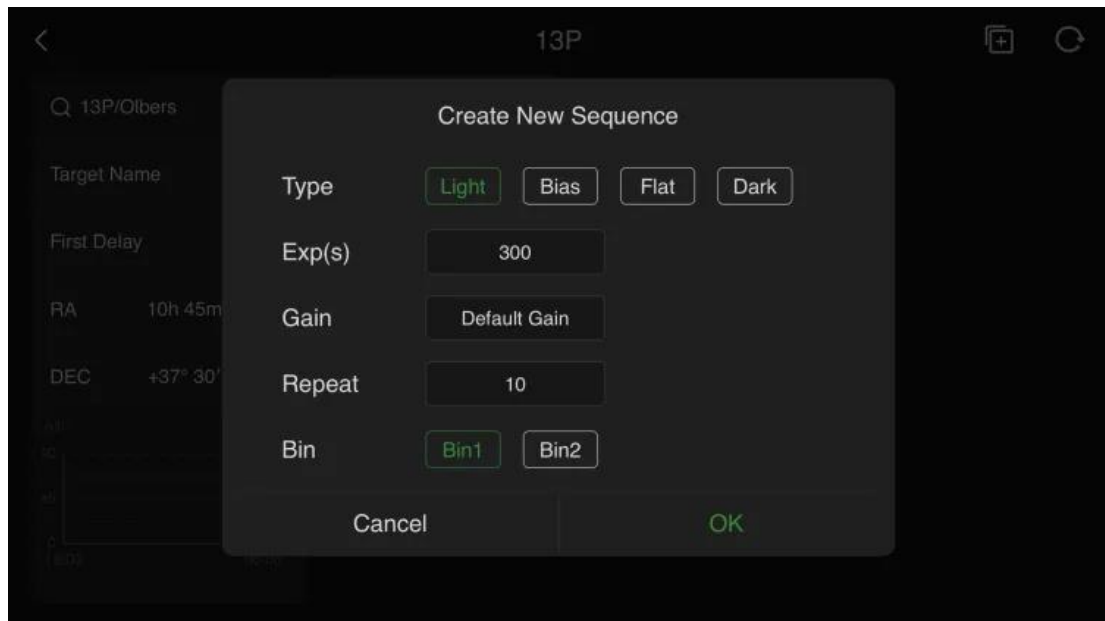

Some stunning deep-sky images you see are the result of long-time exposure and post-processing. The longer the cumulative exposure time for a deep-sky target, the clearer the image. You need to take multiple sets of image frames and stack them in software.

Step 1: Before starting a shooting schedule, you need to guide the mount to accurately track the target. Switch to "Preview" mode, take an

exposure to ensure there are stars in the image, and keep guiding during your entire shooting schedule.

Step 2: Switch to "Preview" mode, select the target you want to capture, GoTo the target, and take an exposure to adjust imaging and composition.

Step 3: Create a shooting schedule that includes dark frames, flat frames, bias frames, and light frames. Once the plan is created, click the start button to get it up and running. During the imaging process, ensure the main camera, guiding camera, mount, and other equipment are properly connected.

If you need to modify the shooting schedule during the imaging process, you will need to reset the current imaging progress.

7.3.8. Plan Mode

Click "Preview" and switch to "Plan" mode. Here you can add and select multiple celestial objects you want to capture. Return to "Preview," click the "Start" button, and the ASIAIR App will capture the multiple targets sequentially.

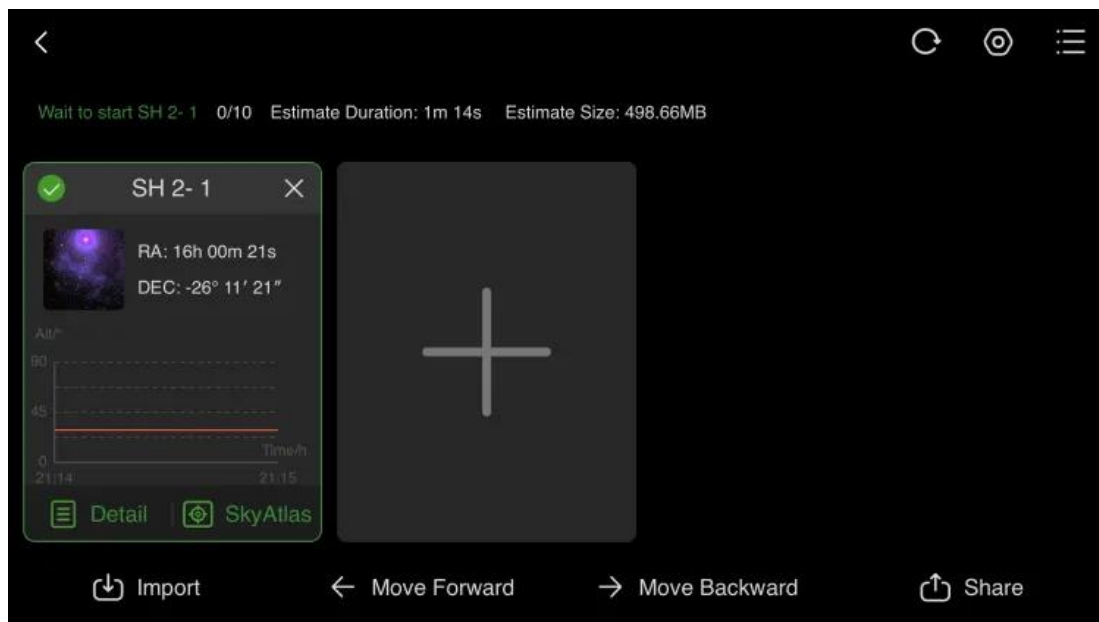

7.3.9. Others

7.3.9.1. Mount Control Panel

The ASI AIR App offers a convenient and powerful tool for controlling the movement of the mount, selecting imaging targets, performing GoTo, and centering targets. This tool is referred to as the "Mount Control Panel (MCP)." Let's explore the control panel from top to bottom:



Q SH2-119 Target Search Box: Tap to enter the "Object Library" interface. We've carefully selected over 14,000 solar system and deep sky objects, and there's a "Tonight's Best" list to make target selection easier. For enthusiasts who might want to capture targets not included in the object library, the app provides the option to add custom targets.

GO GoTo Button: After selecting a target from the object library, you will return to the MCP interface. At this point, tap the button to have ASI AIR control the mount, move to the target's location in the sky. The target will be centered automatically.



Direction Buttons and Speed Slider: These can be used together to select different movement speeds and move the mount's RA or DEC axis for preferred framing or other needs.

Tracking: Tap "Tracking"; green indicates tracking is on, red indicates tracking is off.

Current Object Library Includes Deep sky object catalog (NGC/IC/M/SH2/C/LDN), solar system object catalog, famous star catalog, double star catalog, comet catalog, etc. Future updates will continue to expand this list.

The mount control panel is only effective for GoTo mounts. It can not control the mount with On-Camera ST4 drive.

7.3.9.2. Auxiliary Tools

① Left Side of the Operation Panel

Histogram

The image histogram displays the distribution of pixel brightness and pixel count in the current image. The horizontal axis represents pixel brightness values, and the vertical axis represents pixel count. It also shows maximum, minimum, average values, and standard deviation. You can manually stretch the histogram by dragging the two triangular buttons on the histogram coordinate system. You can also tap the zoom button to enlarge the statistical range for fine-tuning. It is recommended to turn on the automatic adjustment button for the histogram, allowing the software to automatically stretch the histogram.

Focuser

After connecting the EAF, you can use the EAF control panel for coarse and fine adjustments to get the telescope focused.

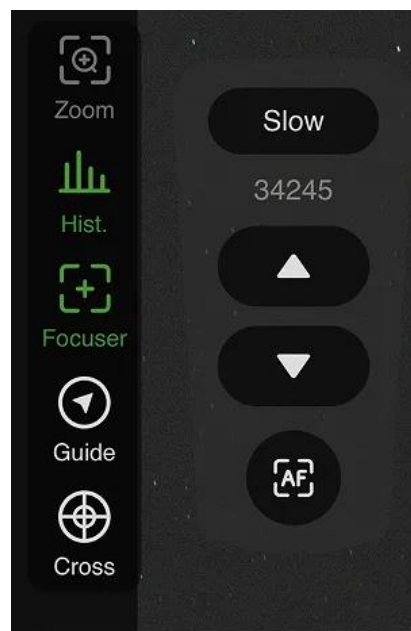

Guide

Pup up the guiding floating window

Plate Solve

Analyze the current image to determine the actual coordinates (equatorial coordinates) that the mount is pointing to. This can be used for mount alignment; after solving, click "Sync to Mount" in the popup window. The solve function is also essential for GoTo, Auto Center and Polar Alignment.

Star Detection

Calculate the average size of stars in the current image.

Annotation

Label celestial objects in the captured images .

Crosshair

Use the crosshair to better compose the imaging target.

② Right Side of the Operation Panel

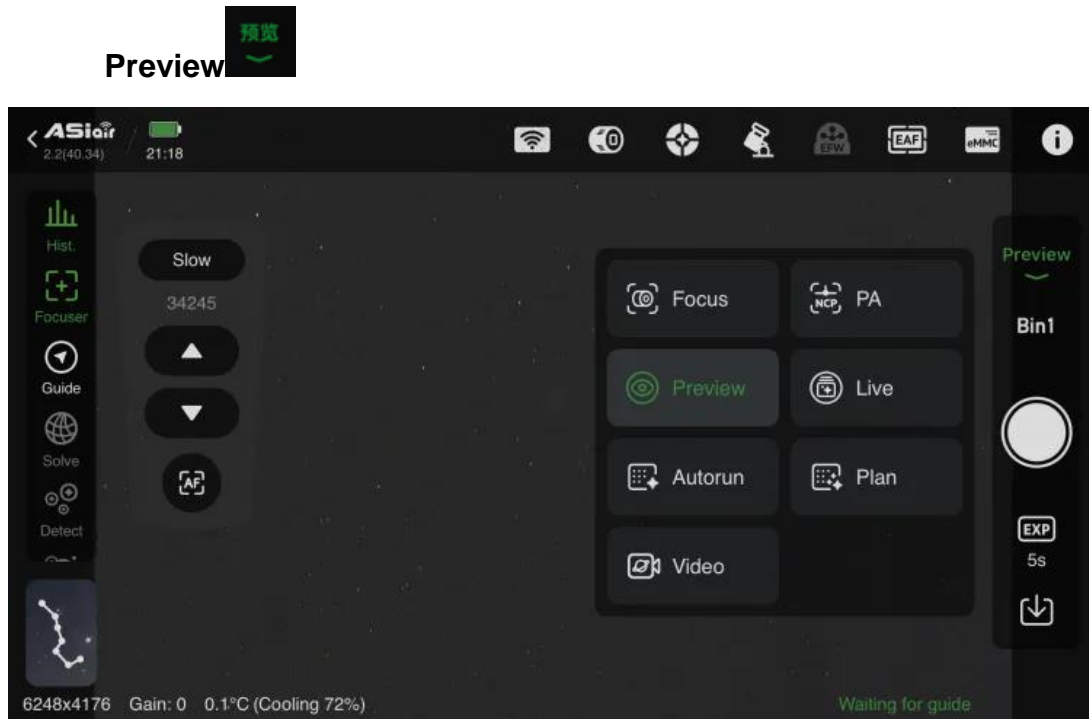

Preview: Click "Preview" to switch between Focus, Polar Alignment, Aotorun, Plan, Live Stack, and Video mode.

Aotorun: Create your own imaging plan and start your imaging session according to your preferences.

Plan Mode: Select multiple celestial objects for imaging; ASI AIR App will photograph them in sequence.

Live Stack: In this mode, images will be stacked in real-time during imaging to obtain higher quality images.

Video Mode: This mode supports video recording.

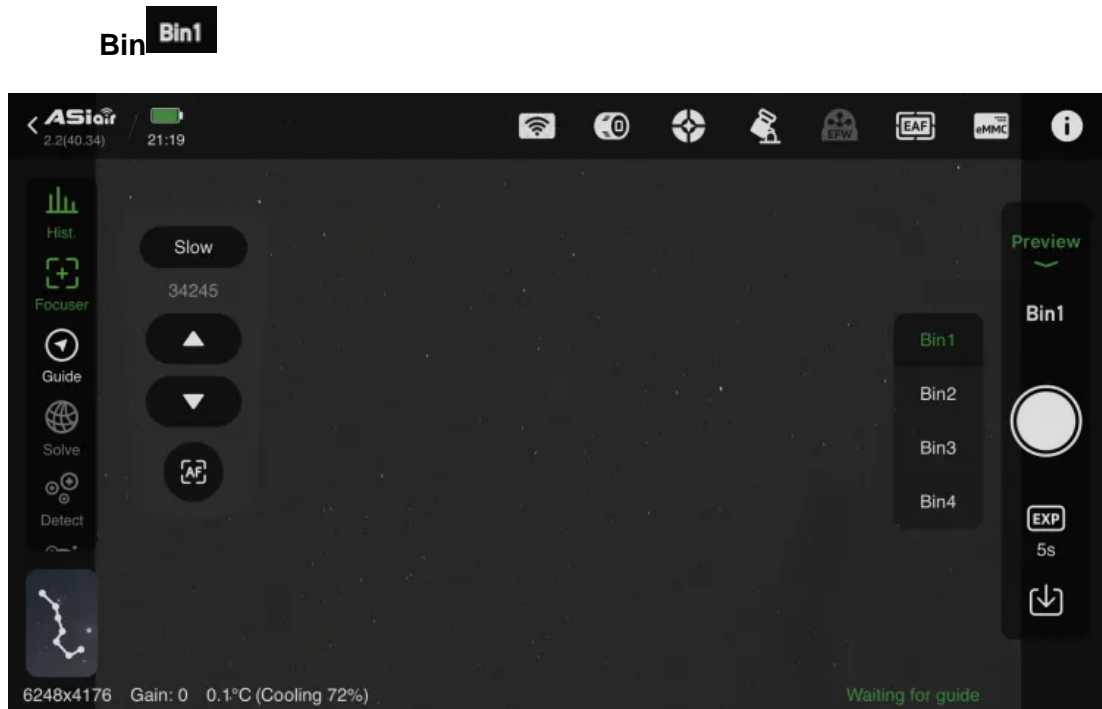

During fine focusing, adjust focus based on the principle that a smaller HFD value under Bin1 indicates better focus (can be adjusted from the MAX Bin down to Bin1).

Bin1: Each pixel is used individually.

Bin2: 2x2 pixels are combined into one.

Bin3: 3x3 pixels are combined into one.

Bin4: 4x4 pixels are combined into one.

Binning can improve the signal-to-noise ratio and enhance image clarity.



Tap "Start" to initiate the capture process.



Click "Exposure" to set the exposure time, ranging from 0.001s to 1000s.

8. Astrophotography with ASISudio

ASISudio, developed by ZWO, is a comprehensive astrophotography software suite that integrates several essential tools for astrophotography. It supports multiple platforms (MacOS 10.12 and above, Windows 7 and above, Linux (recommended Ubuntu 16.04 and above)) and features a user-friendly interface, easy-to-use functions, and an automatic version detection and update feature.

Below, we will use the Windows version of ASISudio to demonstrate how to connect a wireless smart camera and capture images.

8. 1. Download and Install ASISudio

Visit the official website. Download the "ASISudio" installation package.

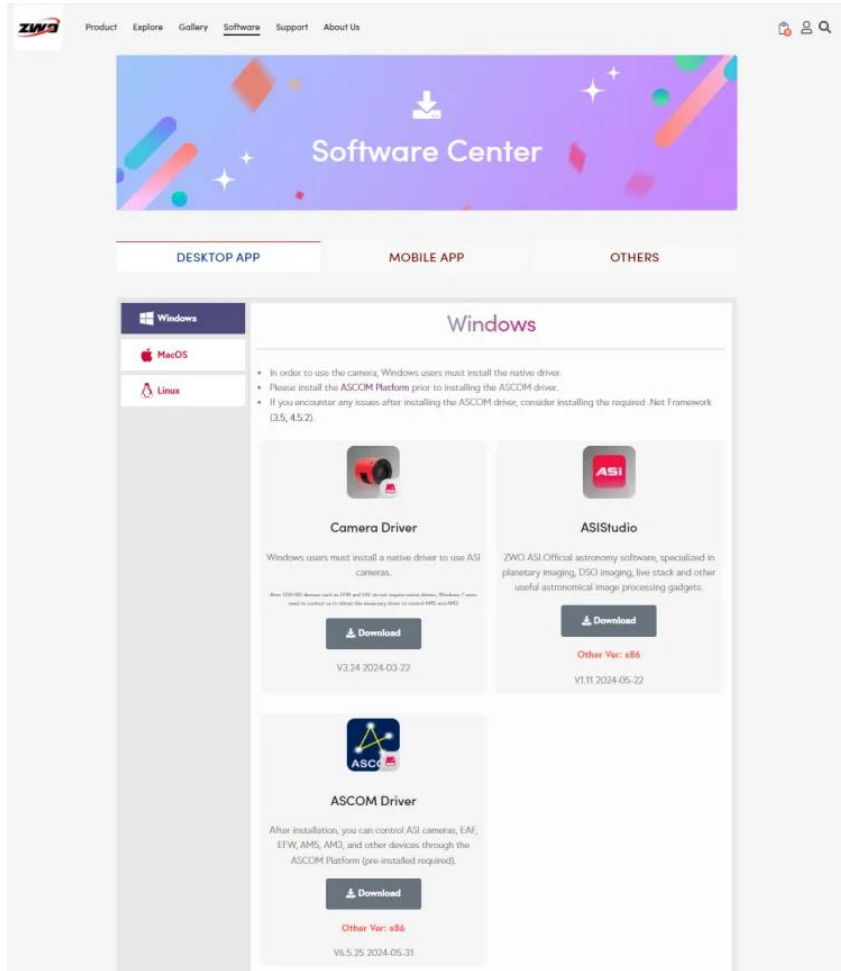

After downloading, double-click the installation packages and follow the prompts to install both the ASI camera driver and the ASIStudio software.

8. 2. Connect the Camera and Capture Images

Power on the wireless smart camera and connect your computer to the camera's Wi-Fi hotspot.

Open ASIStudio and select the deep-sky imaging software ASIIImg.

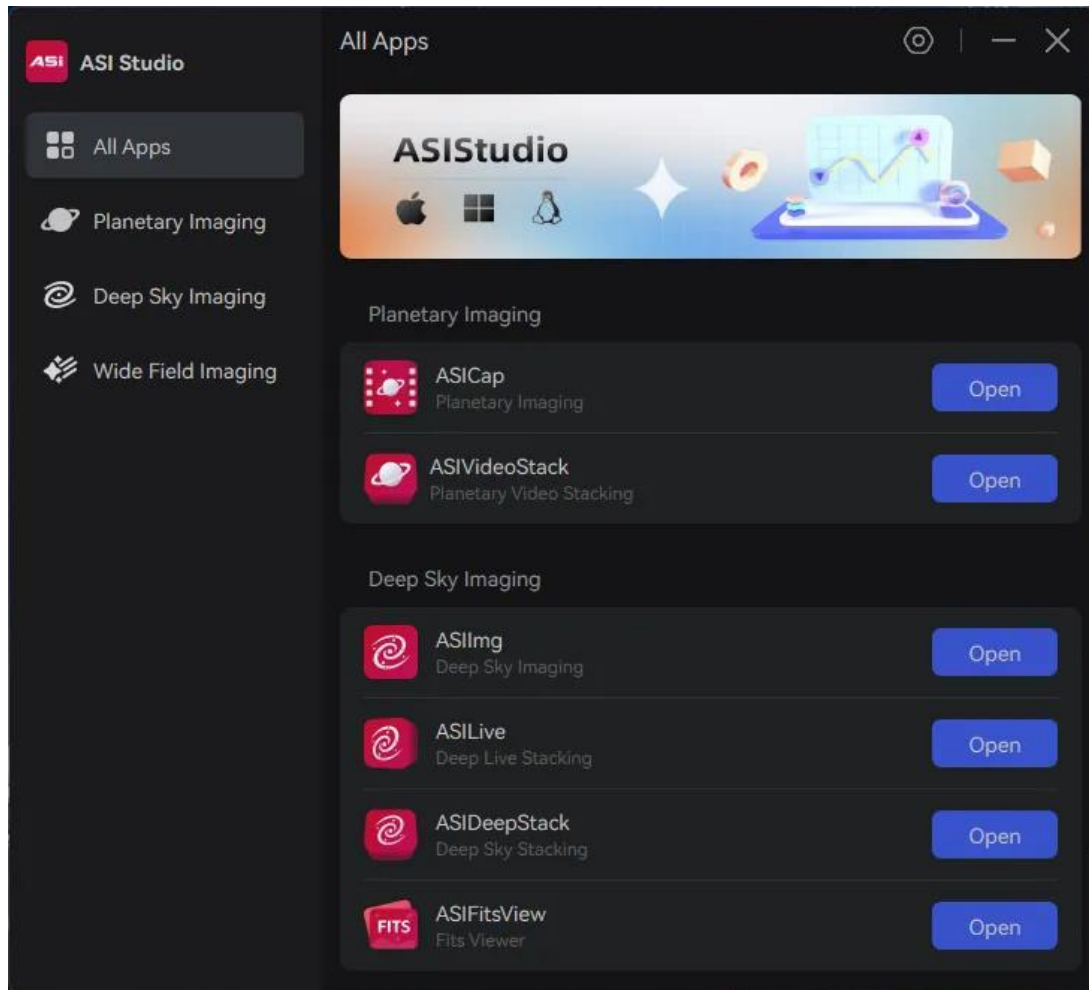

Once your computer is successfully connected to the camera's Wi-Fi hotspot, you should see the camera listed in ASIIImg, typically displaying the main sensor name.

Set the relevant imaging parameters for the camera, and you are ready to start capturing images.



8.3. Additional Astrophotography Software

Apart from the official ASIStudio software, the wireless smart camera also supports control and imaging using third-party computer software compatible with ASCOM drivers.

First, please visit the ASCOM Standards website (<http://www.ascom-standards.org>) to download and install the ASCOM Platform. For controlling the smart wireless camera, it is recommended to install version 6.6 or above.

After that, you can use third-party software such as MaxIm DL, NINA and PHD2 to control your camera. Here let's take MaxIm DL as the example.

Connect your computer to the wireless smart camera's Wi-Fi hotspot.

Open the MaximDL software. In the Camera Control section, select Camera 1 and Camera 2 to set up the cameras.

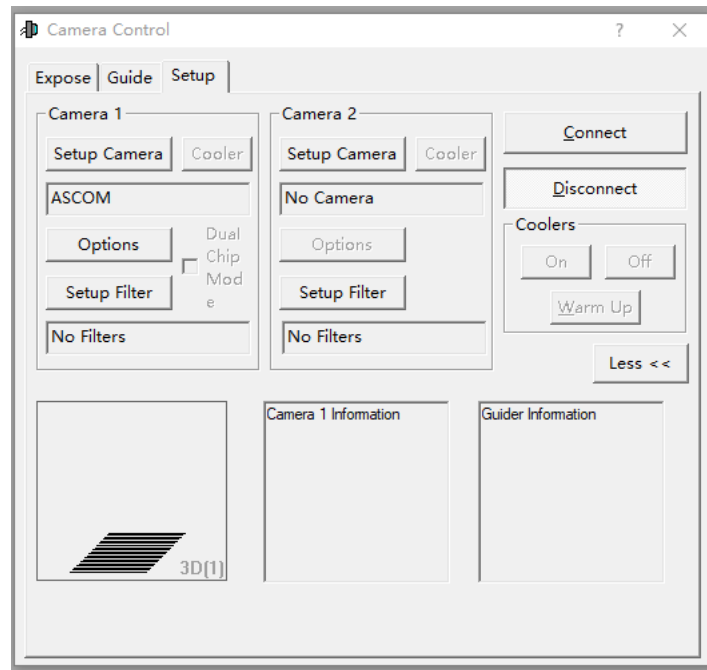

In the setup window, choose Camera Model as ASCOM and click on Advanced.

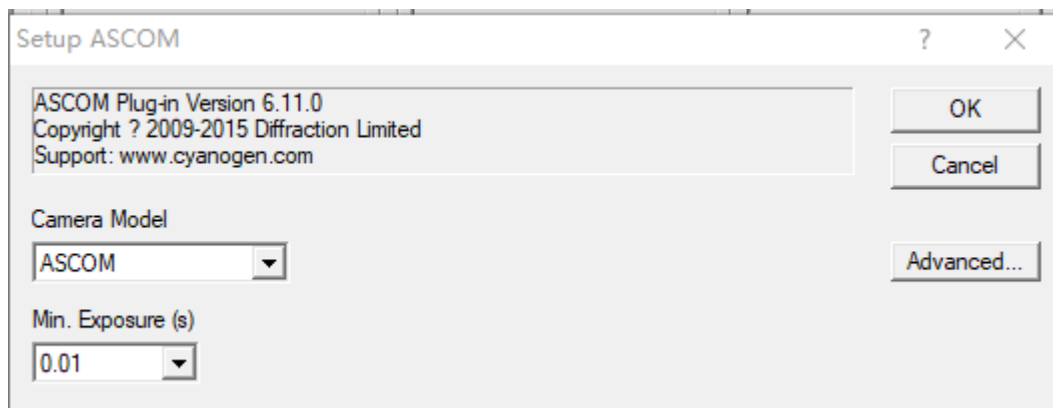

In the ASCOM Camera Chooser interface, select "Alpaca". Enable Discovery and then click Discovery Now. Now you will see Alpaca device in the drop-down box.

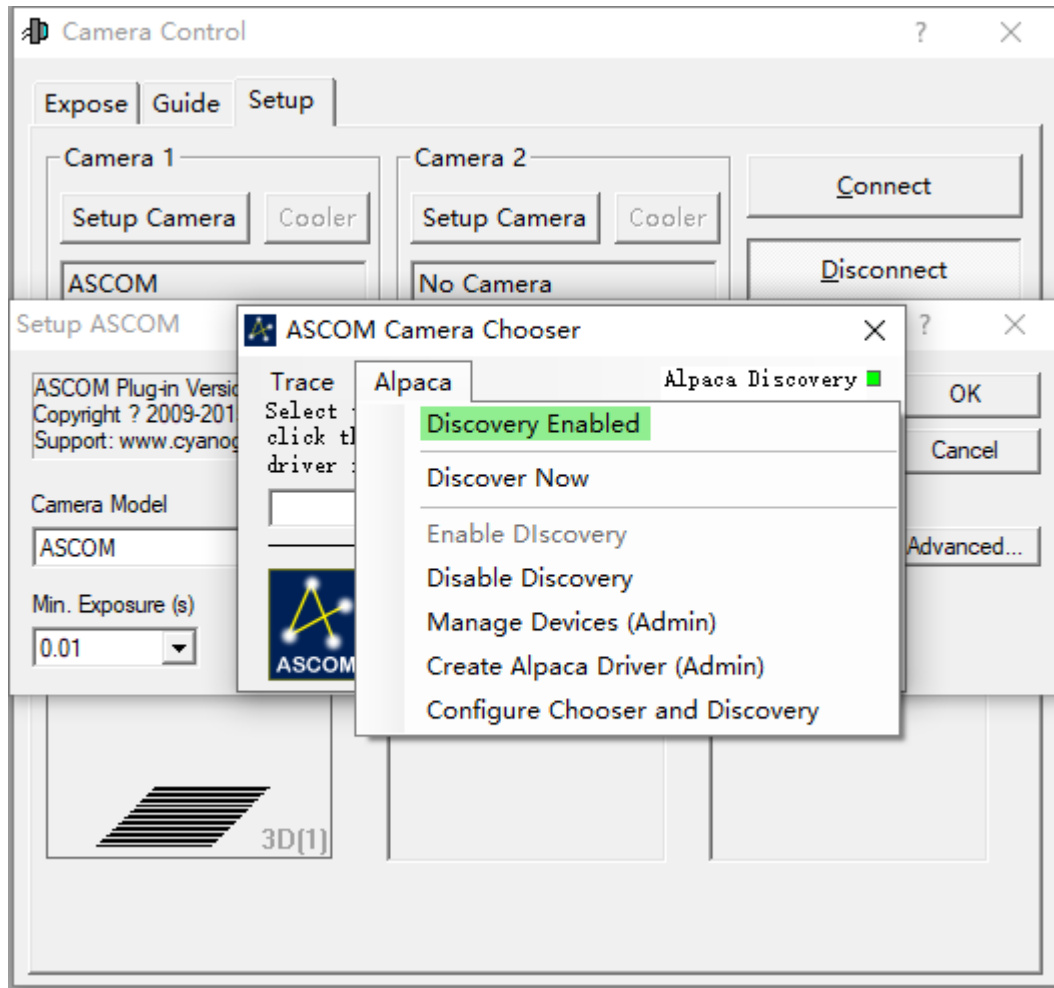

In the dropdown menu, select *NEW ALPACA DEVICE ZWO ASIxxxx Air and click OK. The wireless smart camera will provide options for both the main camera and the guiding camera. Configure Camera 1 and Camera 2 as the main camera and guiding camera respectively.

An authorization reminder will pop up after the above steps, click Yes.

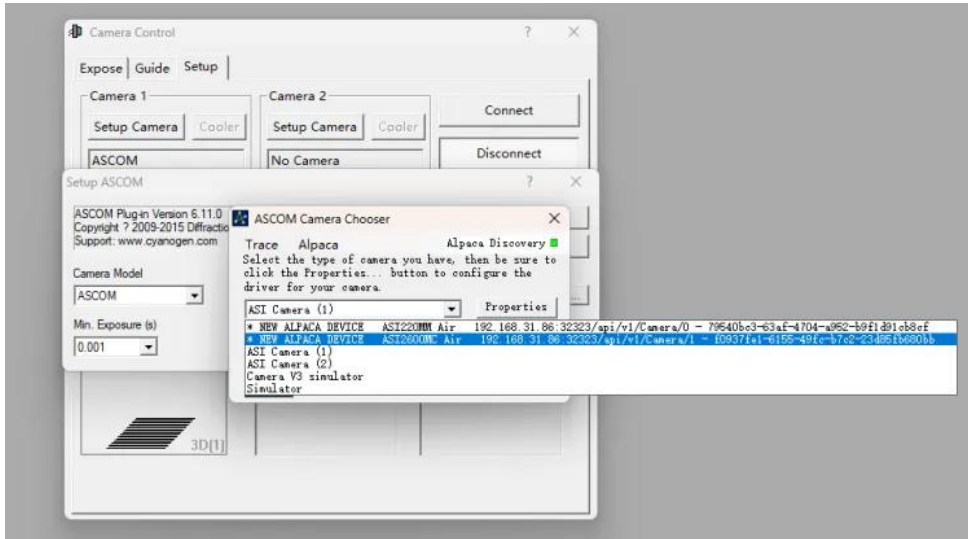

Click Connect to connect to the camera. Now you can control the camera on PC.

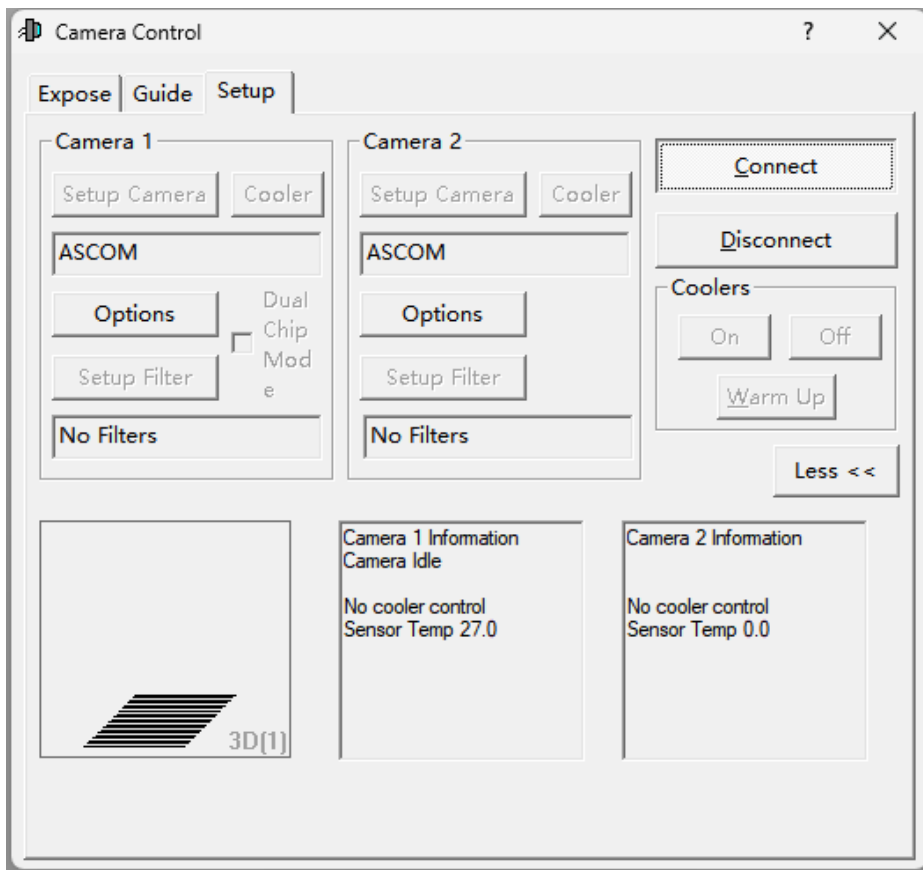

Go to Expose and Guide Pages to complete the setting before you start imaging with the wireless smart camera.

9. Others

9.1. Firmware Update

The wireless smart camera regularly receives updates that introduce new features and optimize performance. The software updates are divided into firmware and App updates. The firmware update is distributed with the new versions of the ASIAIR App. When you download a new version of the ASIAIR App and connect to the wireless smart camera, the App will prompt you to update the firmware. Confirm the update and wait a few minutes for it to complete.

If the firmware upgrade fails, exit the ASIAIR App. Unplug the power cable from the wireless smart camera, then plug it back in to restart the device. Try the update process again.

9.2. Wi-Fi Reset

If you are unable to find the Wi-Fi signal from the wireless smart camera, you can reset the Wi-Fi settings. Ensure the camera is powered on. Press and hold the RESET button for 5 seconds. Release the button when you hear the voice prompt saying "Device is reset, ready to connect." The hotspot, password, and bridging data will be reset successfully.

10. Servicing & Warranty

Please visit the official website to learn about the latest after-sales policies and warranty service terms.

Users in mainland China: Please visit the Chinese website:

<https://www.zwoastro.cn/policy>

Users in Hong Kong, Macau, Taiwan, and other overseas countries and regions: Please visit the English website:

<https://www.zwoastro.com/warranty-return-policy/>

11. Contact Us



ZWO website



Facebook



Instagram

ZWO website: <https://www.zwoastro.com/>

Facebook: <https://www.facebook.com/zwoastro>

Instagram: <https://www.instagram.com/zwoastro/>

Email address: info@zwoptical.com

Submit a ticket on ZWO support page:

<https://support.astronomy-imaging-ca>