

ZWO-AM5

User Manual



Table of Contents

Preface

Tips

Package Lists

1. Product Introduction

2. Performance Parameters

3. How to Use

3.1 Introduction to the AM5

3.2 Introduction to the Hand Controller

3.3 Mounting the AM5

3.3.1 Mount installation

3.3.2 Mount hand controller

3.3.3 Bluetooth Connection

3.3.4 Optional accessory installation

3.4 How to use AM5

3.4.1 How to adjust the latitude from the first gear to the second gear

3.4.2 How to adjust the azimuth scale

3.4.3 How to switch the equatorial /alt-azimuth mode

3.4.4 How to control the AM5 on PC

3.4.5 How to control the AM5 via ASIAIR

3.4.6 How to control the AM5 via Bluetooth/Wi-Fi

3.4.7 How to Upgrade the Firmware of AM5

4. Structural Dimensions

5. After sales

6. Warranty



Scan me to view
quick start tutorial

Preface

Thank you for purchasing the ZWO Harmonic Equatorial Mount, the ASI Mount 5 (hereafter referred to as the AM5 Equatorial Mount). ZWO, through years of research and tailored specifically to the demands of astrophotography, has engineered a harmonic drive with ultra-low periodic error and a stable transmission of high torque output. Each AM5 Equatorial Mount includes in the box a comprehensive 360° Periodic Error (PE) test report to ensure performance. Utilizing belt-driven technology, it achieves an overall reduction ratio of 300:1 for precise control. The AM5 Equatorial Mount embodies an integration of single-piece manufacturing processes and modern industrial design principles. While focusing on portability, it also prioritizes stability during use rather than solely pursuing lightness. Its well-balanced lightweight design does not come at the expense of stability. As a harmonic German equatorial mount, it boasts sufficient load capacity to support a range of portable professional astrophotography equipment. The AM5 Equatorial Mount has been developed with full intellectual property rights in both hardware and software and is perfectly compatible with ASI AIR. Furthermore, it supports platforms such as ASCOM and INDI. The mount features quick response, precise tracking, convenient operation, and wide compatibility, meeting the demands of both visual astronomy enthusiasts and astrophotographers. It will enrich the celestial exploration journey for all astronomy lovers.

The purpose of this manual is to introduce the methods of using the equatorial mount through textual explanations and illustrations and to alert users of potential improper operations or hazardous situations. Please ensure that you thoroughly read and understand this manual before operating the equatorial mount and that you operate the mount strictly according to the instructions provided. Any damage to the equipment or personal injury resulting from improper operation shall be the responsibility of the user.

Tips

This manual can guide users to use the equatorial mount safely and efficiently. Before using the equatorial mount, please make sure to carefully read the following warm tips and strictly adhere to the guidance of this manual during actual use.

- 1) When using this equatorial mount, do not observe the sun directly with the naked eye through the telescope or finder scope, as this can cause permanent and irreversible damage to the observer's eyes. When observing the sun, please be sure to equip a special solar filter;
- 2) Please choose the appropriate tripod and balance weight carefully according to the size and weight of the primary mirror. The harmonic equatorial mount without added weights will cause the telescope's center of gravity to deviate from the tripod. Please test the center of gravity changes of the telescope when turning to various directions in advance to avoid the equatorial mount tipping over, which can cause equipment damage or personal injury;
- 3) If the equatorial mount is powered on not at the zero position, please return to the zero position first, then proceed with other operations. After using the equatorial mount, please return it to the zero position first, then disconnect the power, otherwise, it may cause the next start-up to be inaccurate or use the GOTO function to cause equipment damage or personal injury;
- 4) Please avoid children touching the equatorial mount alone to prevent the equatorial mount from tipping over or causing personal injury. In addition, the small parts included in this equatorial mount may also cause choking or other injuries to children;
- 5) Do not place the equatorial mount in environments with high humidity or high salinity, which will cause corrosion to the parts of the equatorial mount, which may lead to the equatorial mount running poorly or reduce the accuracy of the equatorial mount, and even cause short circuits and permanent damage;
- 6) Do not use corrosive solutions to clean the equatorial mount to avoid corroding the surface oxide layer, damaging the equatorial mount; and avoid exposing the equatorial mount to the sun for a long time to prevent discoloration of the exterior oxide layer;
- 7) Do not attempt to disassemble the equatorial mount alone, this may cause damage to the equatorial mount, reduce the accuracy of the equatorial mount, and even cause personal injury to the user;
- 8) The equatorial mount is a precision instrument, please handle it with care to avoid knocking and damaging the equatorial mount, reducing accuracy;
- 9) The operating temperature range for the equatorial mount is -20°C to 40°C . Do not use it outside this temperature range to prevent the equipment from not functioning properly, resulting in equipment damage. If not used for a long time, please store it properly in the packaging box.

Package Lists



- ① Foam packaging box x1
- ② Equatorial mount unit x1
- ③ 2-meter USB 2.0 cable (Type-B to Type-A) x1
- ④ AM5 periodic error test report x1
- ⑤ Quick guide x1
- ⑥ Control hand pad x1
- ⑦ 2-meter hand pad connection cable x1
- ⑧ 1-meter USB 2.0 cable (Type-C to Type-A) x1
- ⑨ M6 hex key x1 (included within the unit)

1. Product Introduction

AM5 is the first equatorial mount in ZWO's ASI Mount series. It has been greatly improved compared to its original edition, offering larger load capacity, higher precision, better low-temperature tolerance, and better cable management, greatly enhancing the user experience. This mount combines portability, accuracy, intelligence, and high performance, catering to the diverse needs of astronomy enthusiasts in the field.

Key features include:

- 1) **High precision:** Equipped with a specialized astronomical harmonic reducer, it achieves high-precision control with a periodic error consistently within ± 10 arcseconds. This ensures stable transmission of large torque output, and each machine's PE error curve is tested to guarantee performance.
- 2) **High load capacity:** The main body weighs 5.5kg and can carry up to 15kg, which can be increased to 20kg with added counterweights.
- 3) **Proprietary control system:** A completely proprietary software and hardware control system maintained and upgraded by a professional team to ensure stability.
- 4) **Dual-mode:** Offers both equatorial and alt-azimuth modes to cater to both imaging and visual observation needs.
- 5) **No regional limitations:** Designed with a 0-90-degree pitch angle, it can be used at the equator and polar regions.
- 6) **Hand controller/APP control:** Features like best targets of the night recommendations, target GOTO, and star chart display on the APP. OTA (Over-the-Air) online firmware upgrades for the equatorial mount and hand controller can be completed on a smartphone without the need for a computer connection.
- 7) **Cable management:** Supports cable management with an integrated DC output and Type-C port on the dovetail board, effectively preventing cable entanglement.
- 8) **Bluetooth functionality:** The APP has added Bluetooth connectivity for controlling the equatorial mount, significantly improving the control experience.
- 9) **Low-temperature high-load mode:** To combat the impact of a low-temperature operating environment on the performance of the equatorial mount, this mode can be activated in the APP to effectively enhance the device's load capacity.

Additional Advantages:

- 1) **Fully sealed transmission components:** The harmonic drive is designed with a fully sealed structure, ensuring that the harmonic reducer does not rust over time and that its performance remains consistent.
- 2) **One-click mechanical zeroing:** The design features mechanical zeroing, supporting a one-click return to zero position from any position.
- 3) **Power-off brake device:** In the event of a power failure, the RA axis has brake protection to prevent the primary mirror from falling and causing damage to the equipment or personal injury.
- 4) **APP/PC software to meet different needs:** Mobile devices can install the "SkyAtlas" or "ASI AIR" APP to control the AM5, while computers support control by ASISudio, ASCOM, and INDI.

2. Performance Parameters

Items	Description
Mount type	German Equatorial Mount
Mount mode	Equatorial/Alt-Azimuth
Drive	Strain Wave Gear + synchronous belt (300:1 reduction ratio)
Periodic error	<±10"
PE duration	288 s
Drive (R.A.)	Stepper motor + synchronous belt + 17 type 100 reduction ratio strain wave gear + brake
Drive (DEC)	Stepper motor + synchronous belt + 17 type 100 reduction ratio strain wave gear
Payload	15kg (without counterweight) /20kg (with counterweight) @25cm
Mount weight	5.5kg
Latitude adjustment range	0°-90°
Azimuth adjustment range	±6°
Dovetail saddle	Losmandy & Vixen
Interface thread for counterweight bar	M12×1.75 coarse teeth
Resolution	0.17"
Max slew speed	6°/S
Slew speed	0.5×, 1×, 2×, 4×, 8×, 20×, 60×, 720×(max speed in heavy duty mode), 1440×
Power port	DC D5.5×2.1mm, center positive (12V, no less than 3A)
Power consumption	Standby: 12V/0.5A, Tracking: 12V/0.7A, GOTO: 12V/1.2A
Auto Guide port	ST4
Communication	USB/Wi-Fi/Bluetooth
Zero position	Mechanical
Operating	-20℃-40℃
Power-off brake	RA axis
Cable Management	Support

3. How to Use

3.1 Introduction to the AM5



- ① **Finder Scope Slot Mounting Hole:** Can be used to mount the finder scope slot, then install the ASI AIR, laser pointer.
- ② **Power Switch:** Connects or disconnects power to the AM5.
- ③ **Latitude Gear Adjustment Screw:** A pair of screws are on both sides of the mount. Loosen them with the M6 Allen key, then adjust your desired latitude gear. Don't forget to tighten them after adjustment.
- ④ **Latitude Lock Knobs:** Loosen the knob to adjust the latitude. Don't forget to tighten it after adjustment.
- ⑤ **Latitude Fine Adjustment Knob:** Rotate it clockwise to get the mount up in latitude and counterclockwise to get it down in latitude.
- ⑥ **Azimuth Fine Adjustment Knobs:** Rotate the knobs in opposite directions to each other to adjust the azimuth base. It is best to keep the knobs slightly done up to prevent wobble.



- ⑦ **Counterweight Bar Screw Hole:** By loosening the nut, you can mount the counterweight bar and counterweights, M12x1.75 coarse thread.
- ⑧ **Auto Guide:** ST-4 compatible autoguiding port.
- ⑨ **USB 2.0 Interface:** Equipped with a USB-B 2.0 port, which can be used to connect devices that support a USB connection. This interface allows for control of the AM5 and firmware upgrades.

⑩ **BT Button/Bluetooth Indicator Light:** The BT button is used during the Bluetooth pairing process to confirm and lock the connection to the correct AM5, preventing accidental connection to other devices.

The indicator light displays a steady blue when the AM5 is powered on and operational. Once the APP successfully connects to the AM5 via Bluetooth, the indicator light turns off. (Note: Bluetooth connections can only be made through the AM5 APP interface).

⑪ **HC:** Hand Controller Interface – used to connect the hand controller device.

⑫ **DC 12V5A:** Power Input Interface. It requires a 12V power supply with a current rating between 3A to 5A and a DC connector size of D5.5×2.1mm with a center-positive, outer-negative polarity (meaning the inner connector is positive (+) and the outer shield is negative (-)). A low voltage alarm is activated, and the AM5's buzzer will sound if the voltage falls below 10.8V, indicating that the power is insufficient.

⑬ **Status:** It is an operation mode indicator light. Red light for the equatorial mode, green light for the alt-azimuth mode. It will flash red and green when the time and location information is not synchronized to the AM5. Once synchronized, it will keep the light on in the mode's color accordingly.



⑭ **Dovetail Saddle Locking Knobs:** Compatible with Vixen/Losmandy style dovetail bars.

⑮ **Latitude Scale:** Indicates the current latitude of the AM5 from 0° to 90°.

⑯ **Dovetail Saddle Plate:** Designed for mounting and securing the telescope's dovetail plate, Compatible with Vixen/Losmandy style dovetail bars.

⑰ **DC Power Port:** DC12V 3A, can power AM5 as well as provide power to external devices like the ASI AIR.

⑱ **Type-C Port:** Can be used to control AM5, update firmware, etc., and connect to devices with a Type-C interface (such as ASI AIR) or a computer (with the same functionality as the previous USB2.0).

3.2 Introduction to the Hand Controller



① **Indicator Light:** Indicates the current speed mode of AM5. When the red light is on, the mount is in high-speed mode (20-1440 times sidereal rate), while a red light that is off indicates low-speed mode (1, 2, 4, 8 times sidereal rate).

② **Joystick:** Can be used to control both axes to move accordingly and vertically press down on the joystick to switch between high and low speed modes.

③ **T Button:** Click to turn tracking on or off. When the tracking is on, the T button will turn the red light on, and the status indicator of the AM5 will flash red (green) in the equatorial (alt-azimuth) mode.

④ **Function Cancellation:** Press briefly to cancel functions, such as stopping the GOTO process on the AM5 by pressing the cancel button.

AM5 Zeroing: Press and hold for 3 seconds to reset the AM5 to its home position.

Mode Switching: While the AM5 is turned off, press and hold the cancel button without releasing it, until the indicator light changes color after the AM5 turns on, then you can release the button. Mode switch on the AM5 succeeds now.

How to determine the current mode of the equatorial mount?

After turning on the equatorial mount, if the indicator light is red within the first 5 seconds, it indicates equatorial mount mode; if it is green, it indicates alt-azimuth mount mode.

Note:

How to get the Wi-Fi information for the hand controller: Each hand controller has a silver nameplate on the back with the Wi-Fi information for that controller, including the SSID and password for the hand controller's Wi-Fi.

If you forget the hand controller's Wi-Fi password: (The hand controller has a built-in Wi-Fi module for wireless control and firmware upgrades.)

If you forget the hand controller's Wi-Fi password, you can reset it by pressing and holding both the tracking and cancel buttons on the AM5 while it is turned off. Continue holding these buttons until 5 seconds after the AM5 powers up and turns on, at which point the hand controller's indicator light will flash, indicating that you can release the buttons. This resets the Wi-Fi password to the default password: 12345678.

3.3 Mounting the AM5

3.3.1 Mount Installation

*Tripod model: ZWO carbon fiber TC40
(optional)

Unfold the tripod



Install the silver mounting plate:

Fix the silver mounting plate onto the base of the AM5 with three M6 screws.



Install the AM5 onto the tripod:

Place the AM5 with the silver mounting plate installed onto the tripod, insert the multi-function support rod as shown in figure below (see figure 1), rotate the knob on the multi-function support rod clockwise and tighten it, then fit the tripod spreader and rotate its knob clockwise to lock it in place.



3.3.2 Mount Hand Controller

Hand Controller Installation:

Connect the hand controller to the AM5 using the supplied hand controller cable, and plug it into the [HC] hand control port on the AM5. The hand controller has a built-in Wi-Fi module, allowing wireless devices with WLAN capability to connect to the hand controller's Wi-Fi for wireless control of the AM5.



3.3.3 Bluetooth Connection

The AM5 has added Bluetooth functionality. If you forget to bring the hand controller when you go out, the APP can control the AM5 via Bluetooth connection.

Here's how:

Open the "SkyAtlas" app, select [Mount Settings], and in [Select Device Control Method], choose [Bluetooth] for a Bluetooth connection. Follow the prompts to proceed. After a successful connection, the blue BT indicator light on the AM5 unit will turn off.



3.3.4 Optional Accessory Installation

A. Pier extension connection to Equatorial Mount (Optional)

a. Assemble the mounting plate onto the equatorial mount

Remove the three M6 screws used to fix the mounting plate on the tripod, and then lock the mounting plate tight onto the equatorial mount.



b. Assembly of the pier extension onto the Tripod:

Mount the pier extension body onto the tripod and tighten the knobs on the tripod to secure it in place.



Insert the multi-function support rod as shown in figure below (see figure 1), rotate the knob on the multi-function support rod clockwise and tighten it, then fit the tripod spreader and rotate its knob clockwise to lock it in place.



- c. Mount the AM5 body onto the pier extension and tighten the knobs on the pier extension.
- d. Pier extension installation Completed.



B. Counterweight Rod/Counterweights Installation (Optional)

How to Determine Whether to Install Counterweights

If the total weight of the telescope and associated equipment is less than 15KG, the equatorial mount can be used without installing counterweights; however, when the total weight exceeds 15KG, the equatorial mount will need to use counterweights, and the total weight should not exceed 20KG (the center of gravity for the load including the counterweights should be within a 25cm lever arm).

To ensure the stability of the entire system, when the total weight of the telescope and associated equipment reaches 15KG, it is advisable to use counterweights. The counterweight rod has a threaded interface with a coarse thread size of M12×1.75.

Counterweight Rod/Counterweights Installation Steps:

- a. Locate the counterweight mounting screw hole at the bottom of the AM5 unit.
- b. Unscrew the counterweight rod thread hole protective nut counterclockwise until it's

completely unscrewed and removed, exposing the screw hole.

c. Align the counterweight rod with the screw hole and rotate it clockwise to tighten it, then install the counterweights.

d. Install the nut removed in step 2 onto the end of the counterweight rod.



3.4 How to use AM5

3.4.1 How to adjust the latitude from the first gear to the second gear

Introduction to the latitude gear:

The AM5 equatorial mount's latitude adjustment is divided into two gear positions, with a range of 0 to 60 degrees for the first gear and 30 to 90 degrees for the second gear. When the equatorial mount is in the first gear, the maximum adjustment angle can only reach 60 degrees; to achieve a larger angle, you need to use a hex wrench to loosen the "latitude gear position adjustment screws" on both sides of the main body. Then, you can pivot the mount and adjust the "altitude fine-tuning knob" to the second gear (at the 90-degree mark on the altitude scale). After the adjustment, tighten the screws on both sides to achieve an adjustment range of 30 to 90 degrees (make sure the latitude tensioner is in a relaxed state when adjusting the altitude). It is recommended to adjust the equatorial mount's gear position when it is not carrying any load.



Adjust the latitude from the first gear to the second gear (Adjust the latitude angle from 0° to 90°), as follow:

Loosen the "altitude tensioner" on both sides. Rotate the "altitude fine-tuning knob" clockwise until the hexagonal screw (the "altitude gear position adjustment screw") is fully visible from the hole (approximately at the first gear, 45° position).



①



②

Using an Allen wrench, turn the hex screws on both sides counterclockwise to fully loosen them.



③



④

Manipulate the equatorial mount to slide and adjust the "altitude fine-tuning knob," allowing the hex screw to slide to the bottom end of the hole's slide rail, with the scale screw indicating at the 90° position. At the same time, expose the hex screw and retighten the hex screws on both sides (Note: After adjusting the gear position, be sure to tighten the gear screws firmly, otherwise the equipment may become loose and the gear adjustment function can be easily damaged).



⑤



⑥

At this point, the equatorial mount is in the second gear position. In this state, the equatorial mount can adjust the tilt angle within a range of 30° to 90°. After the adjustment is completed, tighten the altitude tensioner.



To adjust from the second gear to the first gear, simply reverse the steps outlined above.

3.4.2 How to adjust the azimuth scale

Rotate the Azimuth fine adjustment knobs in opposite directions to each other to adjust the azimuth scale of the AM5. It is best to keep the knobs slightly done up to prevent wobble.



3.4.3 How to switch the equatorial /alt-azimuth mode

The indicator light being constantly red signifies the equatorial mount mode, while a constant green indicates the altitude-azimuth (alt-az) mode. Before the equatorial mount acquires GPS and time information, the indicator light will remain on for only 5 seconds and then proceed to a flashing state, alternating between red and green.

Mode switching: [Reminder: Before switching modes, turn off the equatorial mount and remove any load.]

To switch from equatorial mount mode to altitude-azimuth mode:

Connect the hand controller. Long-press and hold the [CANCEL] button, then turn on the AM5. Wait until the indicator light turns green before releasing the [CANCEL] button. Next, adjust the AM5's altitude angle to 90° (for specific operations, refer to section 4.1). The AM5 has now successfully switched to altitude-azimuth mode.

To switch from altitude-azimuth mode to equatorial mount mode: Connect the hand controller. Long-press and hold the [CANCEL] button, then turn on the AM5. Wait until the indicator light turns red before releasing the [CANCEL] button. Next, adjust the AM5's altitude angle to match the latitude value of your location (for specific operations, refer to section 4.1). The AM5 has now successfully switched to equatorial mount mode.

Note 1:

After the AM5 is powered on, if the indicator light flashes alternately red and green following a 5-second constant illumination, you need to connect the AM5 to the relevant app or computer to synchronize location and time information. Once the synchronization is successful, the indicator light will revert to displaying the working mode status.

Note 2:

After switching modes on the equatorial mount, be sure to tighten the gear position adjustment screw. Otherwise, the device may loosen.

Note 3:

When installing the telescope in the altitude-azimuth mode, please position the telescope tube to point to the left side, as shown in the diagram below (when the altitude-azimuth is in the zero position, the dovetail slot tension knob should be facing upwards). If the telescope is installed in the opposite direction, tracking errors may occur during the GOTO procedure.

Correct Installation Method



Incorrect Installation Method



3.4.4 How to control the AM5 on PC

Preparation: Power on the equatorial mount, and connect the AM5 to the computer's USB port using the ZWO USB-B to USB-A 2.0 cable.

(1) Go to the ZWO official website: <https://www.zwoastro.com/downloads> and select [Download].

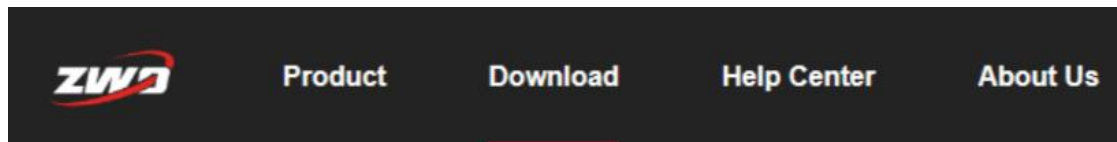

Home > Help Center > Download

(2) Click the area marked '1' in the image to download the ASCOM Platform, and then click the area marked '2' to download the ASCOM driver (choose the appropriate version based on your computer's operating system).

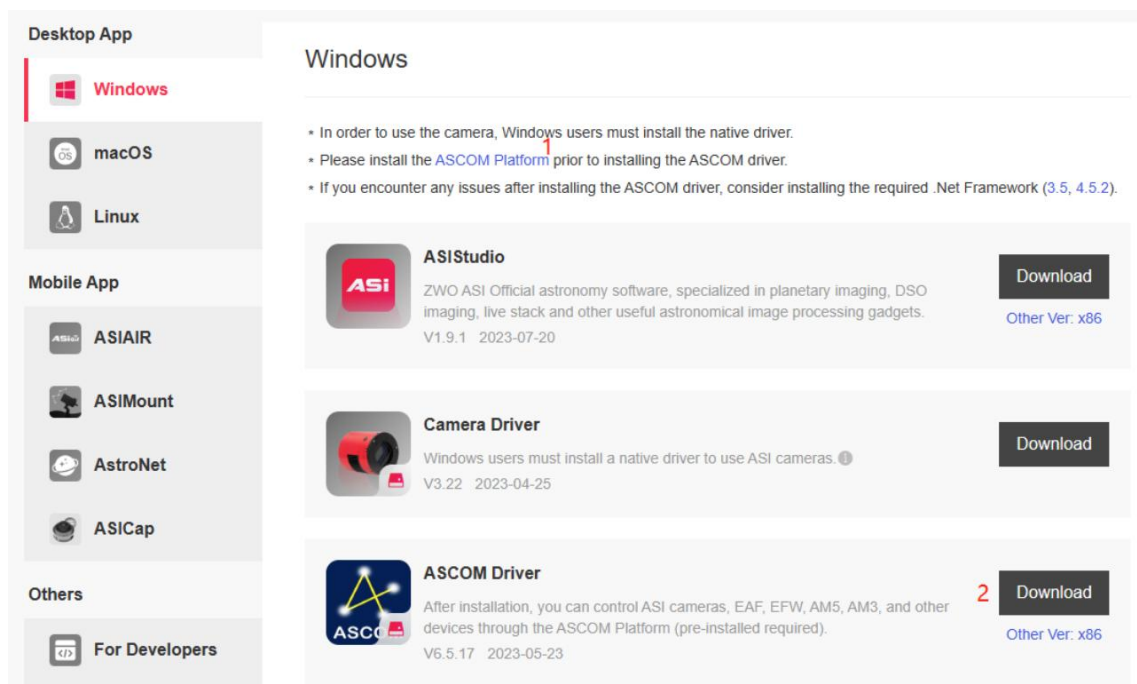

(3) After the download is complete, install the ASCOM Platform and the ASCOM driver in that order, following the installation prompts to complete the process step by step.

(4) Download and install software applications that support the ASCOM driver, such as ASI Studio, MaxIm DL, NINA, SGP, and other computer software.

In the equatorial mount section of the corresponding software, ① select ASIMount, ② click on [Properties], and a new dialog box will pop up.

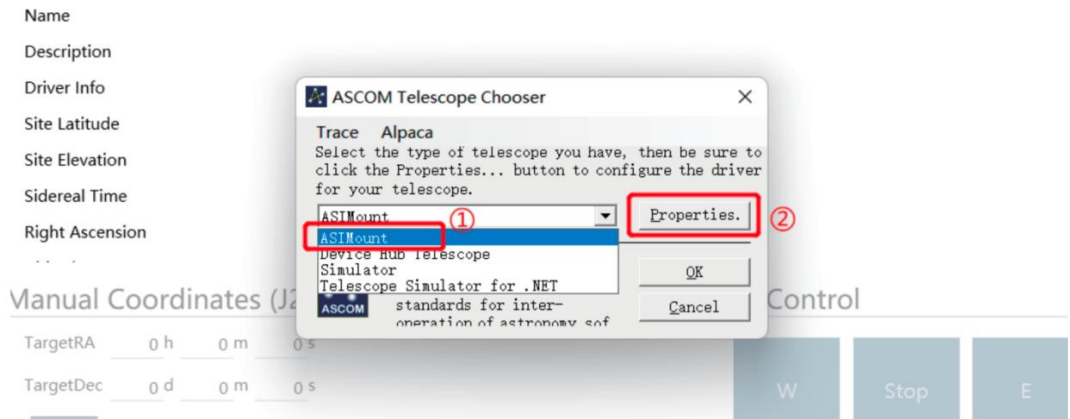

A.

- ① Click on the dropdown menu button in the new window, ② select a port *, ③ then click on [Connect] to connect the equatorial mount to the computer.

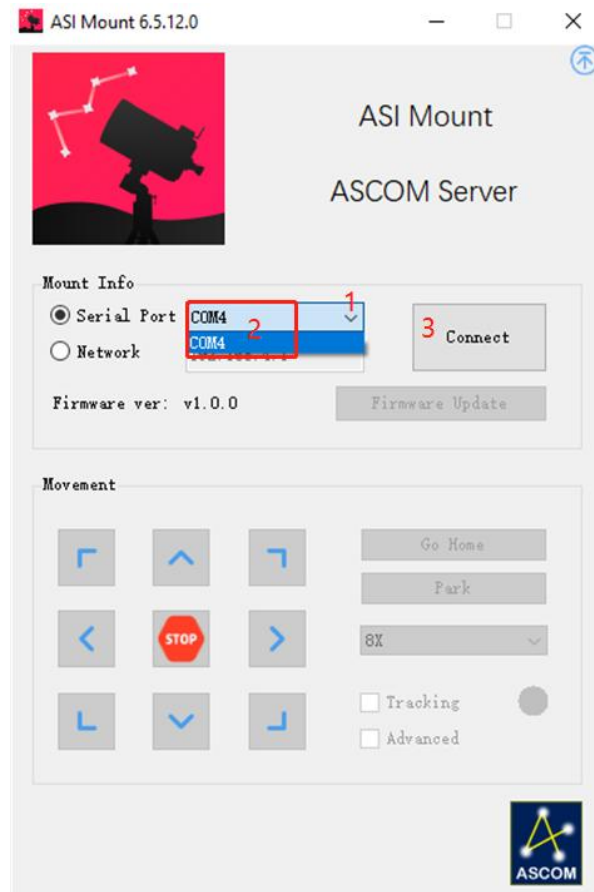

* **Note:** The port number to select can be found in Computer Management, as shown below; alternatively, you can try each of the serial ports provided in the ASI Mount ASCOM interface one by one.

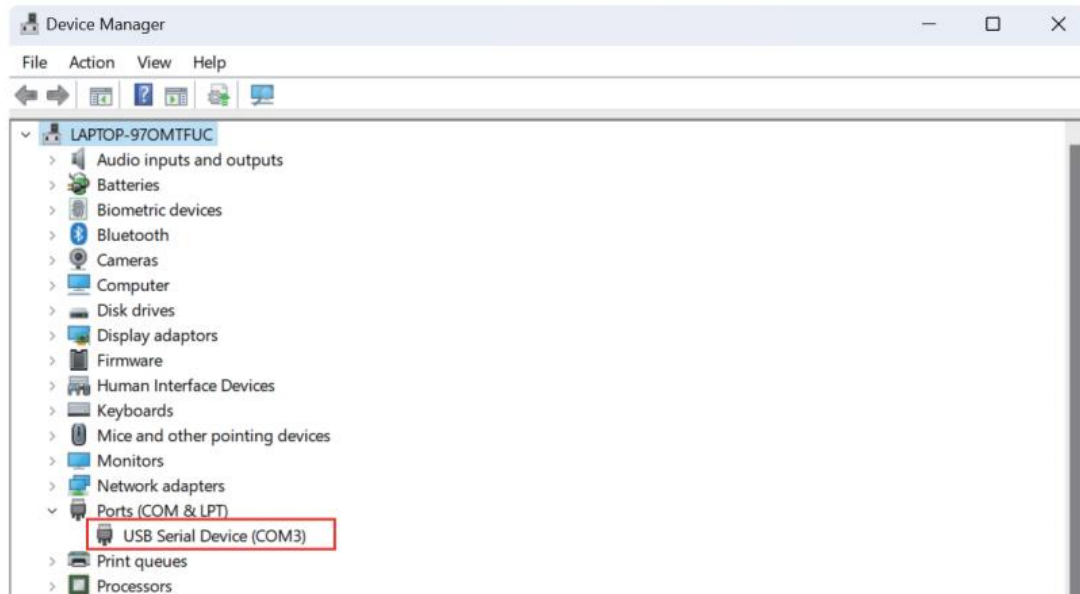

B.

Success! Click or long press the directional buttons marked in the image below to control the movement of the AM5.

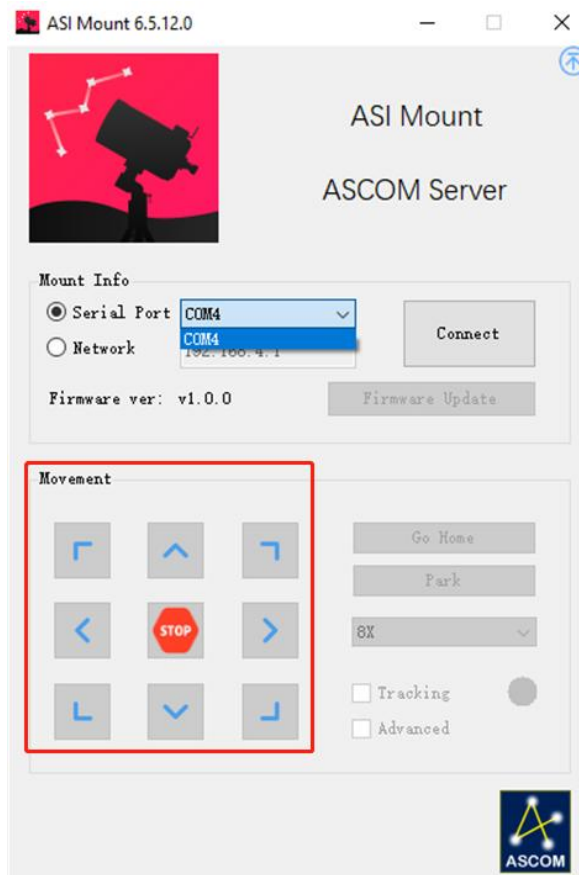

3.4.5 How to control the AM5 via ASIAIR

(1) It is recommended to secure the ASIAIR in a suitable location.



(2) After powering on the entire system, select the corresponding ASIAIR wireless signal in the mobile phone's wireless local area network (Wi-Fi settings).

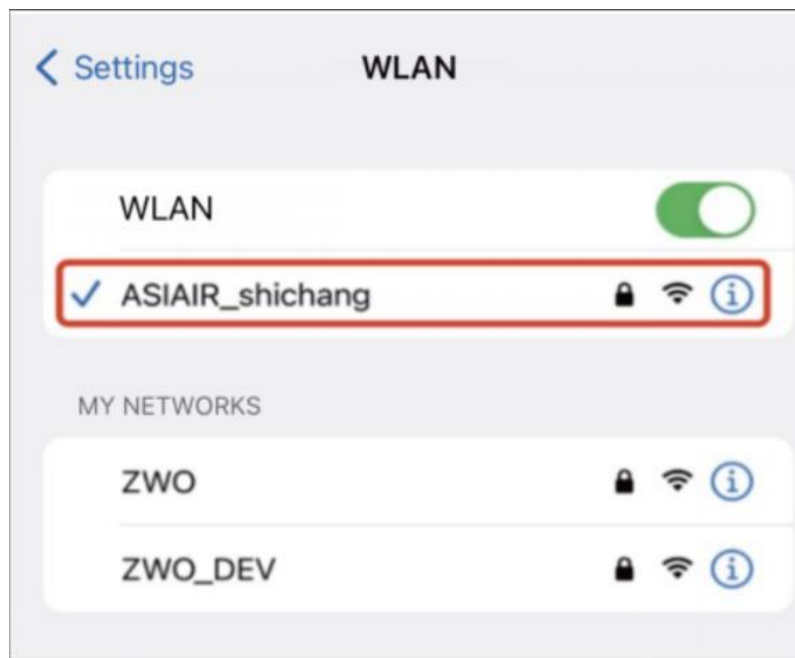

(3) Open the ASIAIR APP, go to the equatorial mount selection page, choose ZWO AM5, and then press the button to start the application (the port will display as connected, and the various parameters of the corresponding equatorial mount will be shown on the page).

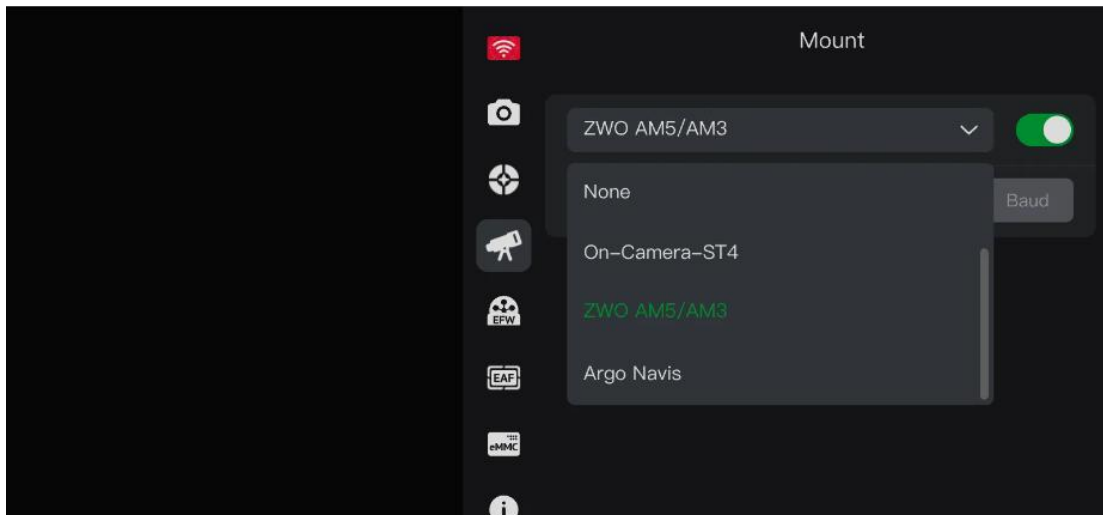

(4) Return to the main page of the APP to set up or activate various devices, and you can control the mount through ASIAIR.



3.4.6 How to control the AM5 via Bluetooth/Wi-Fi

(1) Install the SkyAtlas APP

Scan the QR code with your smartphone as shown below to download and install the "Sky Atlas" APP:



(2) How to control the AM5 via Bluetooth

The AM5 unit is equipped with a built-in Bluetooth module, so if you forget to bring the hand controller when you go out, you can control the AM5 through the APP via a Bluetooth connection.

As follow:

A. AM5 status confirmation:

Check if the [BT] indicator light on the AM5 unit is constantly lit in blue. A constant blue light indicates that the AM5 is ready to connect. If the light is not constantly blue, it means that the AM5 is currently not connectable. You may check the status of the AM5 and restart it, or press and hold the [BT] button for 5 seconds and then check the status of the indicator light.



B. Bluetooth connection:

Start the [SkyAtlas] APP; the homepage is shown as in the following figure. Click the "1" equatorial mount icon to pop up the [Select Connection Method] prompt box, then select "2" [Bluetooth].

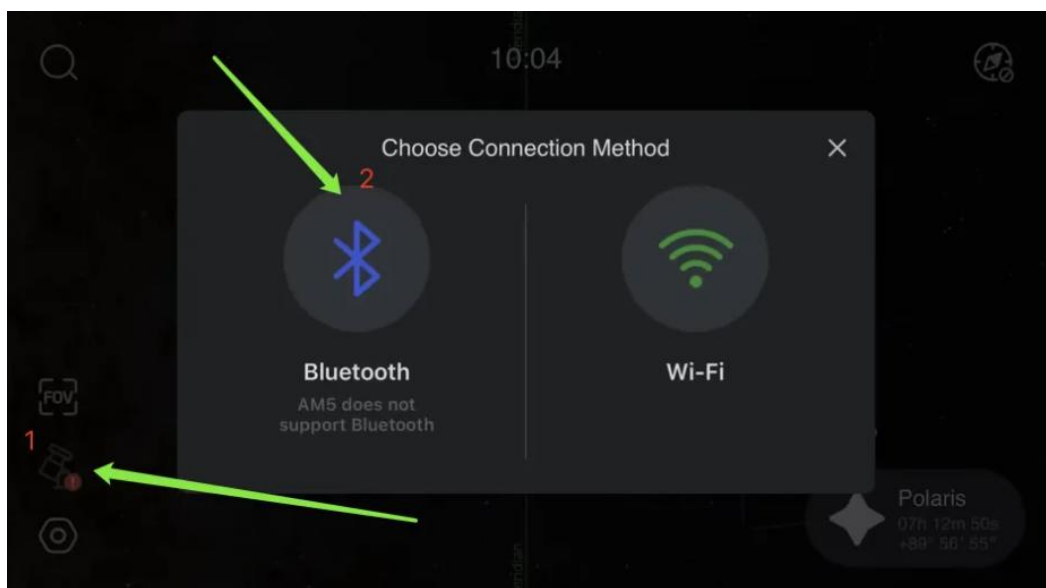

C. Connection confirmation:

Connect to the required AM5 from the equatorial mount list provided by the APP. During the connection process, when the [BT] indicator light is flashing, you need to click the [BT] button on the AM5 to confirm the device. After the connection is successful, the [BT] indicator light on the AM5 unit will turn off.



(3) How to control the AM5 via Wi-Fi

Power on the AM5 and turn it on, connect the hand controller, go to the network connection settings page of the mobile device, and select and connect to the Wi-Fi hotspot name of the hand controller such as [AMH_XXXXXX]. After the connection is successful, return to the APP and upon successful connection, you can control the equatorial mount.

3.4.7 How to upgrade the Firmware of AM5

(1) Update firmware with APP

Step1:

Open the SkyAtlas APP, and connect to the WiFi of AM5's hand controller.

Step2:

Hit the mount icon to enter the setting page.

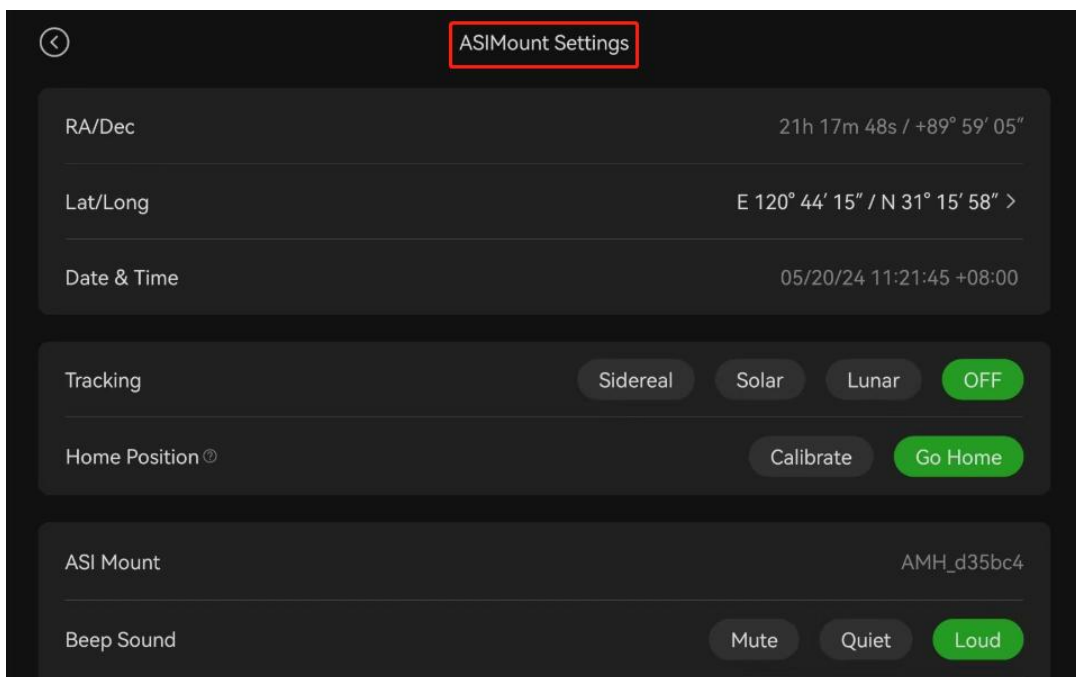
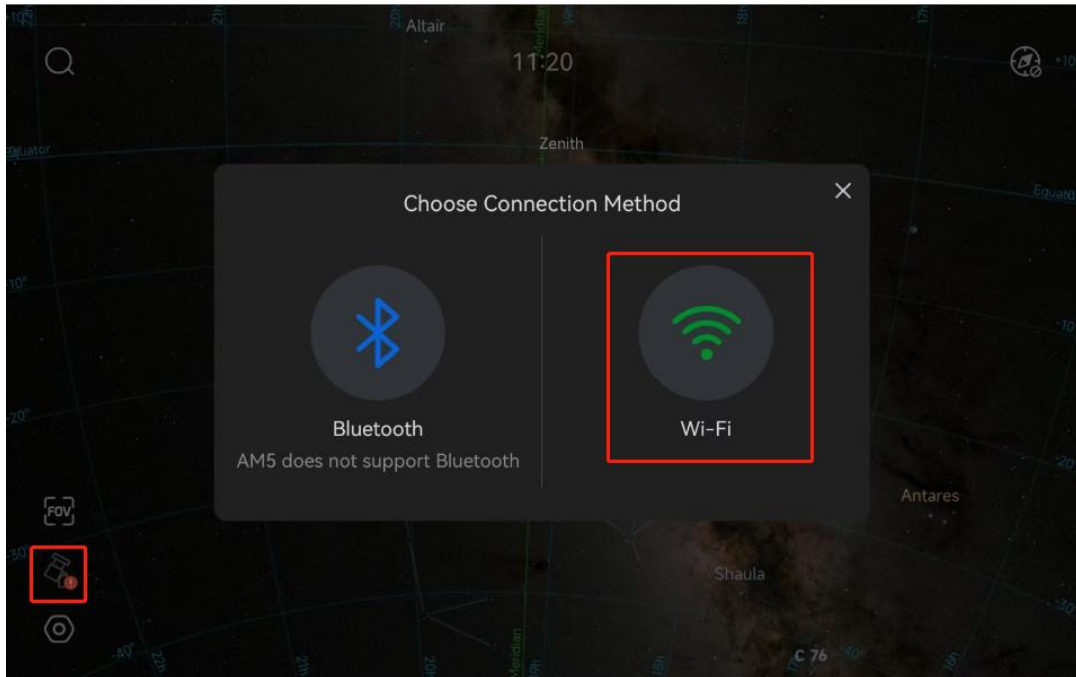

Step3:

Hit “AMH Management System” to enter the firmware update page.

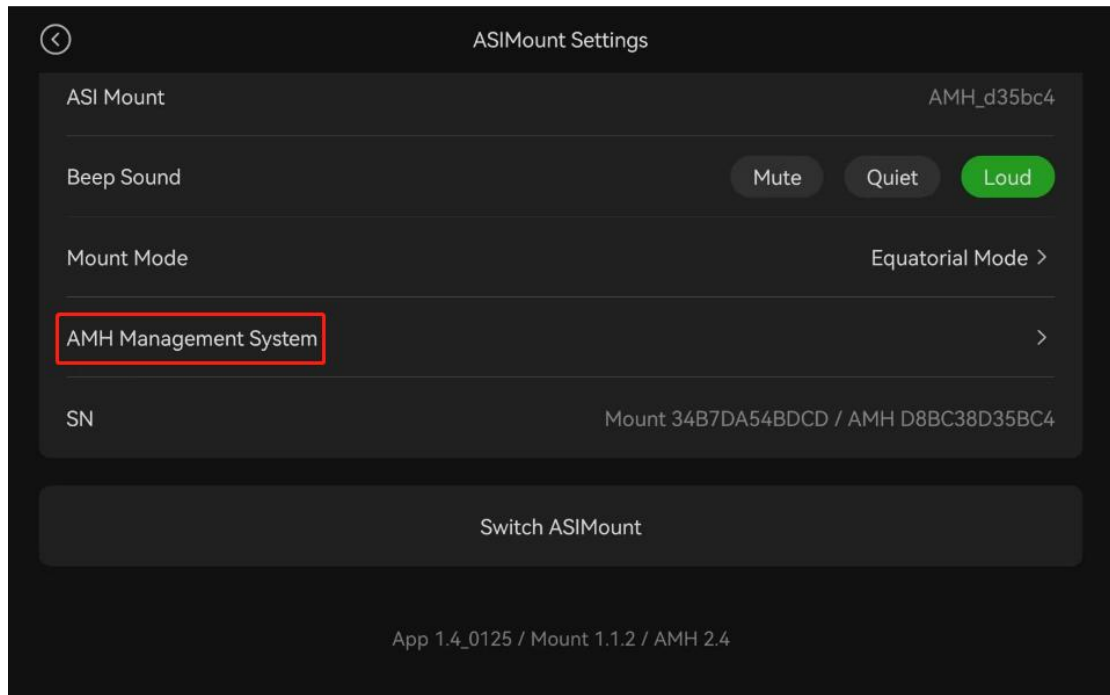

Step4:

Enter the “NETWORK” and enable WLAN, to bridge the current AM5 WiFi to your home router network (ZWO_DEV in our case).

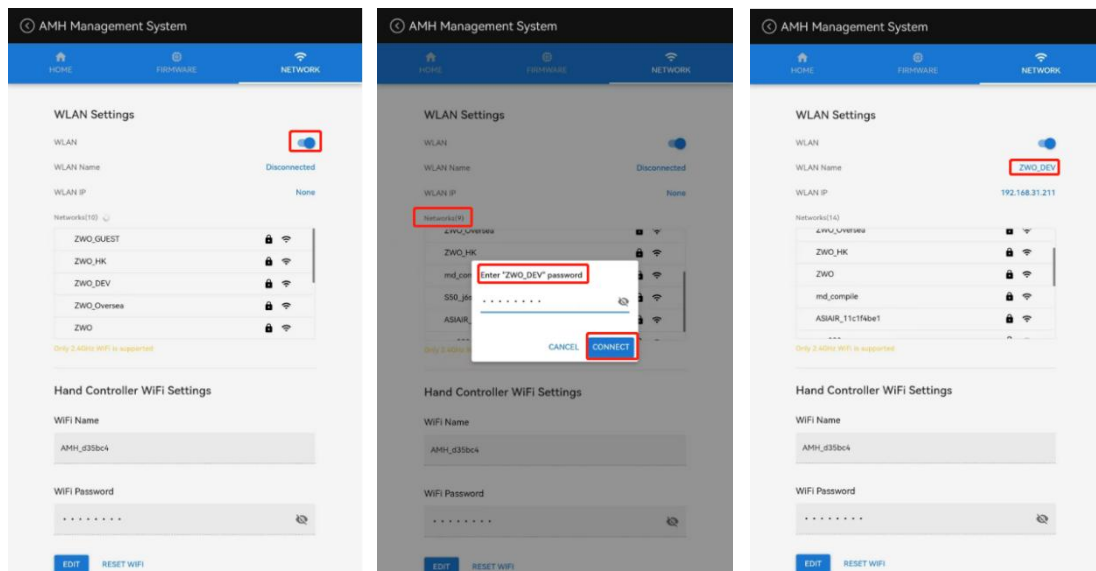

Then hit “FIRMWARE” to update to the latest firmware of the hand controller or the mount.

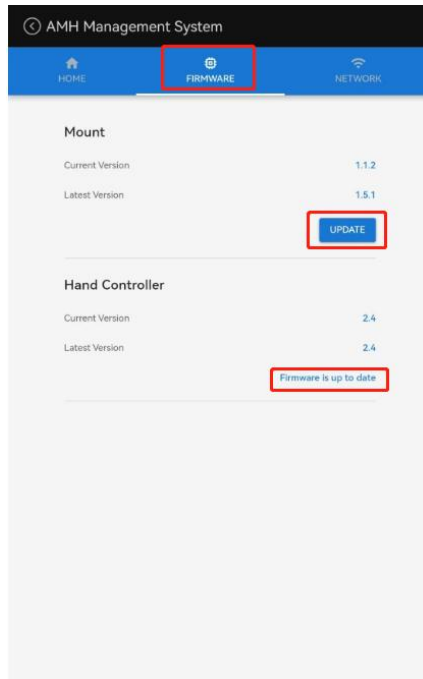

(2) Update firmware with ASCOM

Open ASCOM platform (please refer to 4.4) and follow the steps below.

Step1: Connect the AM5 to your computer with a USB 2.0 cable.

Step2: Click "Serial Port" and then "Connect" to start communication with your AM5.

Step3: Click "Firmware Update" – "Open File", select the local firmware update file. Note that this file needs to be downloaded in advance.

Or click "Online Update" to download the latest firmware file online.

Step4: Waiting for the firmware update to complete.

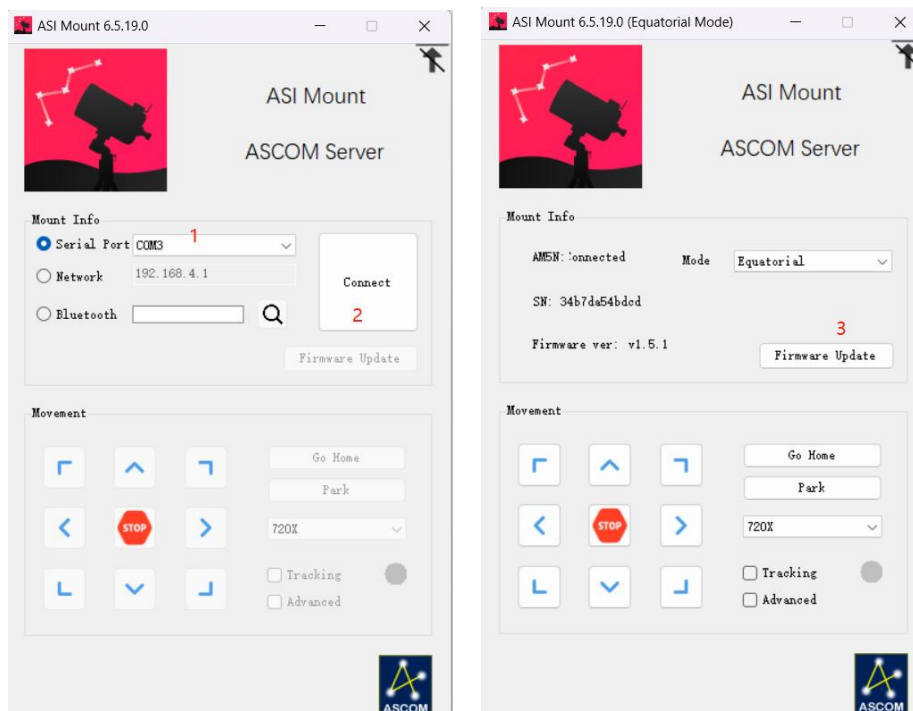

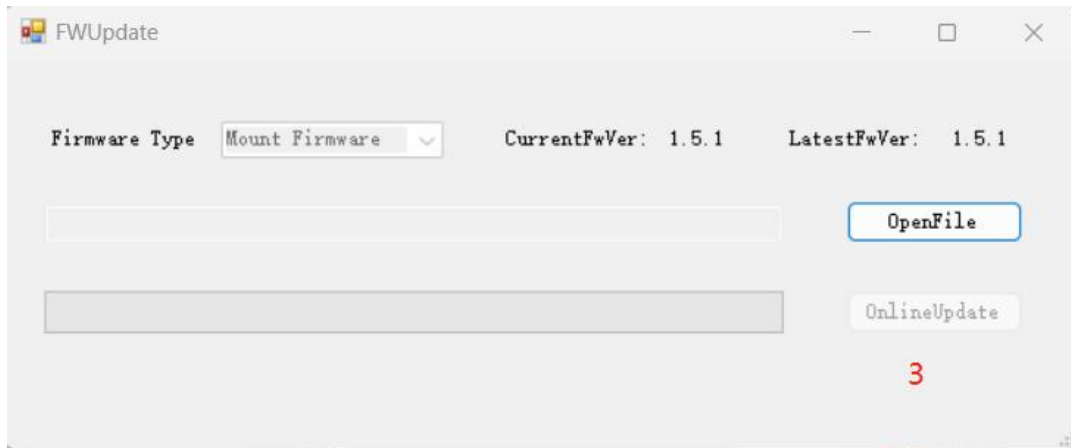

(3) Update firmware with ASISStudio

Open ASISStudio from your computer and follow the steps below.

Step1:

Connect the AM5 to your computer with a USB 2.0 cable. Be sure it is “Serial Port” that you choose.

Step2:

Click the little arrow icon to enter the firmware update page.

Step3:

Click “Install Manually”, and select the local firmware update file. Note that this file needs to be downloaded in advance.

Or click “Online Update” to download the latest firmware file online.

Step4:

Waiting for the firmware update to complete.

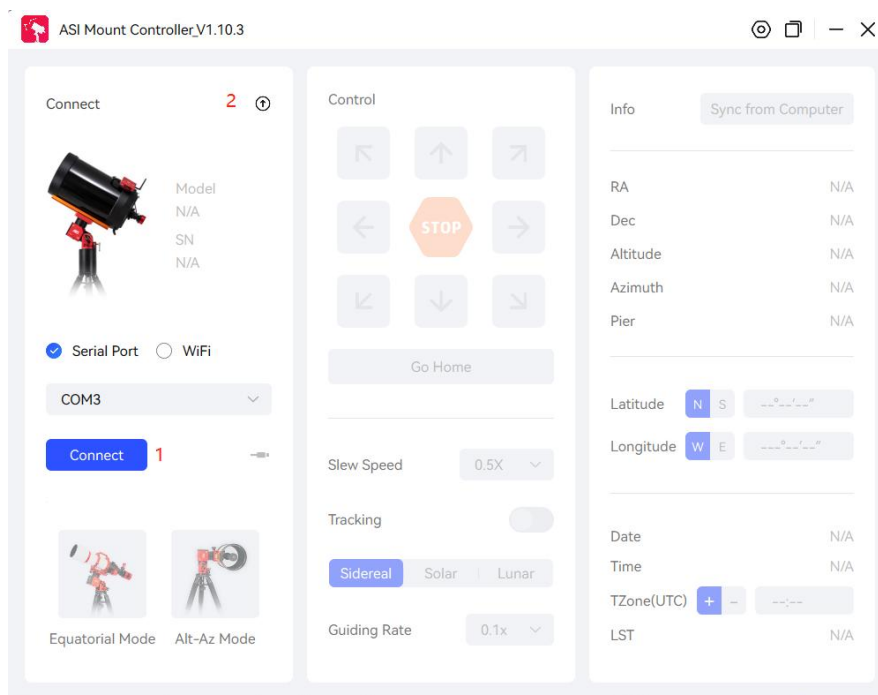

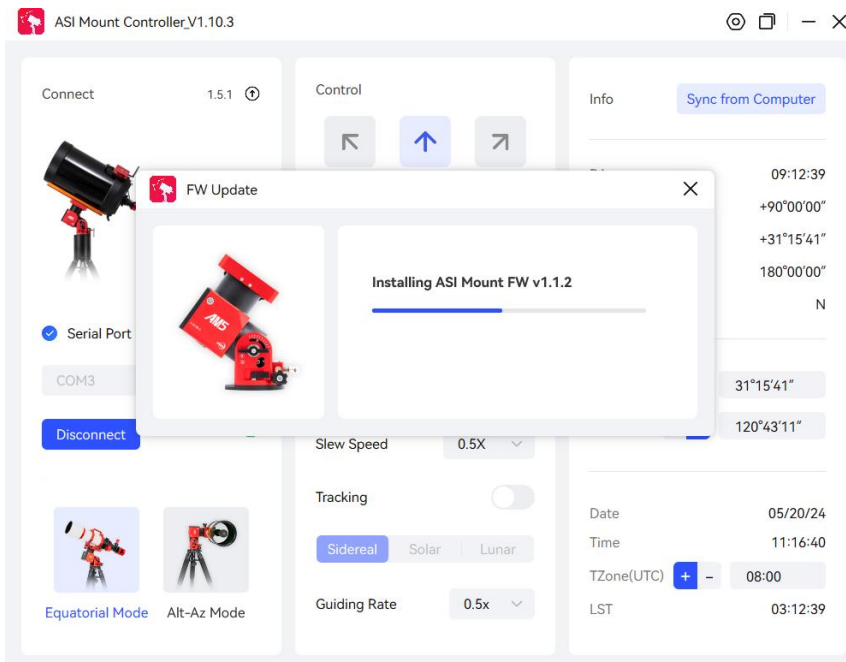
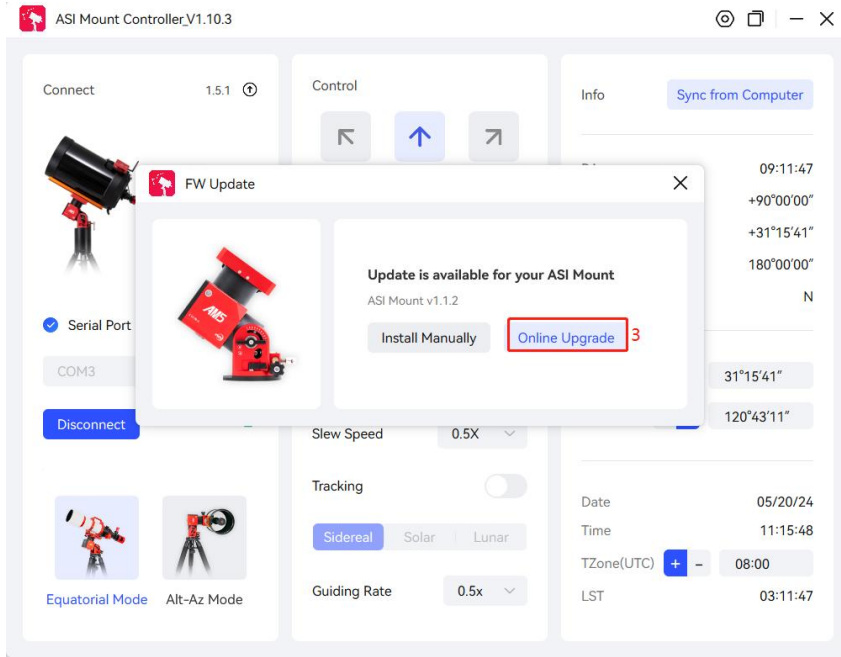

4. Structural Dimensions

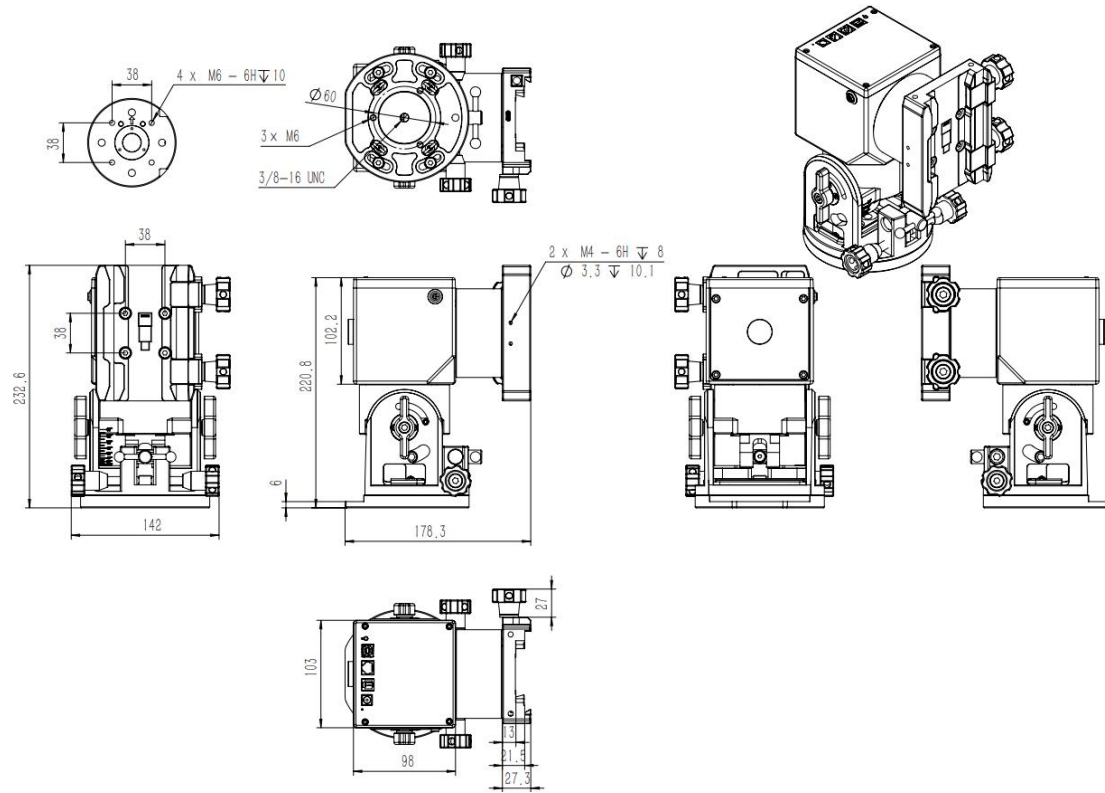

5. After Sales

For software upgrades, please download the update directly from the official website, " Official Website Homepage - Technical Support - Software. "

<https://www.zwoastro.com>

For repairs and other services, please get in touch with us:

Email address: info@zwoptical.com

1. For products usually repaired or replaced within the warranty period, the user will bear the cost of returning them. When sending back the product, the user should note the real cause of the product damage and provide corresponding valid proof, such as pictures or videos. For products that need to be replaced after being confirmed by ZWO in writing, the user should return the fully packaged product with all accessories, manuals, etc., to the address designated by ZWO.

By sending back the product, the user agrees to pay the maintenance fee that may be incurred during the product maintenance process, which is not covered by the warranty service. ZWO will return the product after payment.

2. For products that need to be sent back for after-sales service, ZWO will provide the corresponding RMA code for reference. ZWO will only accept returned products with an RMA number and ZWO's written confirmation.

3. If the user purchased the ZWO product from a ZWO agent, he can directly contact the ZWO agent to obtain relevant after-sales service.

6. Warranty

1. ZWO provides a 2-year free warranty service for the products purchased by users from the company, and the warranty period starts from the day after the user receives the product; for AM5 equatorial mount products, the warranty period starts from the activation date of the user's equipment.

2. If the user encounters the following damage-on-arrival (DOA) situations and contacts ZWO within the corresponding period, and issues product purchase invoices and relevant certificates, ZWO will provide free postage service and offer the following products after-sales replacement (or partial replacement), repair or return (or partial return) service:

1) Product quality problem: If you find a quality problem with the product within 180 days from receipt, you can contact ZWO to confirm it has quality problems or defects after testing by the ZWO customer service center. You can get a free replacement service.

2) Product transportation problem: After receiving the product, the user finds that the outer packaging of the product has obvious signs of water soaking or serious backlog and deformation, and shall provide ZWO with pictures of the outer packaging of the product and receipt of the goods within three days from the date of receipt of the product. After verification by the ZWO customer service center, it is confirmed that the product is directly shipped to the user or agent by ZWO, then ZWO will provide relevant return and exchange services; if the product is directly sold or shipped to the user by the ZWO agent, the ZWO agent will be responsible for providing relevant return and exchange services.

3. If the product occurs in the following situations, it is not within the scope of warranty service, and ZWO can provide maintenance services for users:

1) The product exceeds the warranty period;

2) The product is exposed to liquid and corroded by moisture;

3) The product is damaged by external force (such as scratches on the surface, deformation of the product shell, broken USB port, etc.);

4) Dismantling, third-party maintenance, modification and refurbishment, flashing (downloading wrong firmware) without express written authorization from ZWO;

5) The product system is changed, or the warranty label is lost or changed;

6) Product quality problems caused by failure to install according to product usage requirements or instructions;

7) Physical damage and failure of the product caused by irresistible external forces (such as floods, fires, earthquakes, lightning strikes, and other strong vibrations or extrusions);

8) Damage caused by improper user operation during shooting or use;

9) There is no valid product purchase invoice or warranty certificate;

10) The product purchased by the customer is a second-hand product.

Quality problems with accessories or other product parts are not a condition for returning the host, and users can request a replacement of new accessories separately.