



SkyGuider™ Pro Camera Mount Instruction Manual

Product #3550, #3550A, #3551 and #3552

Table of Content

Table of Content	2
1. SkyGuider™ Pro Camera Mount Overview.....	3
2. SkyGuider™ Pro Camera Mount Assembly	5
2.1. Introduction.....	5
2.2. Parts List	5
2.3. Assembly Terms	6
2.4. SkyGuider™ Pro Camera Mount Assembly	8
3. Advanced Applications.....	17
3.1. Autoguide	17
3.2. Attach a Telescope.....	17
3.3. Dual Camera/Scope Mount.....	18
3.4. Use Optional 8408 Hand Controller	18
3.4.1. Go2Nova® 8408 Hand Controller.....	18
3.4.2. Go2Nova® 8408 Hand Controller Function	20
4. Maintenance and Servicing.....	25
4.1. Maintenance.....	25
4.2. Trouble Shooting	25
4.3. iOptron Customer Service	26
4.4. Product End of Life Disposal Instructions.....	26
4.5. Battery Replacement and Disposal Instructions	26
Appendix A. Technical Specifications	27
Appendix B. Polar Alignment using iPolar Electronic PolarScope	28
IOPTRON WARRANTY	29



WARNING!

***NEVER USE A TELESCOPE TO LOOK AT THE SUN WITHOUT A PROPER FILTER!
Looking at or near the Sun will cause instant and irreversible damage to your eye.
Children should always have adult supervision while observing.***

Please don't charge the battery or use USB power at or below 0°C (32°F), otherwise the rechargeable battery might be permanently damaged.

Ver.3.2

iOptron Corp. reserves the rights to revise this instruction without notice. Actual color/contents/design may differ from those described in this instruction.

1. SkyGuider™ Pro Camera Mount Overview

Introducing The SkyGuider™ Pro -- iOptron's next generation camera tracking device! Leading the camera tracker market for nearly four years, iOptron's SkyGuider Pro pushes closer to perfection.

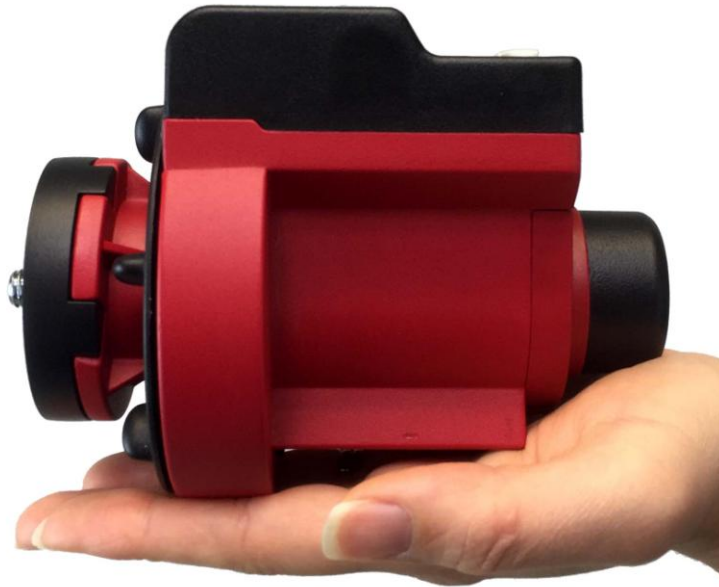

Figure 1. SkyGuider™ Pro mount head only

The redesigned SkyGuider™ Pro mount is more compact, small enough to fit on your palm, better precision, silent tracking, built-in rechargeable power source, ST-4 guiding port and camera trigger port. The improved precision polar scope maintains a fine engraved reticule, now features adjustable illumination with different brightness levels. Using with our iOS app, quick and accurate polar alignment is just a joy. The DEC mounting bracket allows you to balance a heavy camera and/or lens better, or even mount a light telescope. The optional 8408 hand controller allows you to check the Pole Star position for the polar alignment, slew the mount, adjust the guiding rate, change the mount settings and control the camera trigger.

The SkyGuider™ Pro features four tracking rates, 1X or sidereal, 1/2X for sky and landscape combined, solar and lunar. All 4 tracking rates work in both northern and southern hemispheres. We have also added a quick slew mode with both forward and reverse to help quickly reframing your image without disrupting the camera's position.

We have made big improvements on the SkyGuider™ Pro's removable alt-azimuth base, which features a precision bubble level, degree markings for the altitude and a built-in post for the azimuth control. You can also mount the SkyGuider™ Pro head (without the base) directly to any standard photographic tripod with 1/4" or 3/8" threads.

The DEC mounting bracket package, which includes DEC mounting bracket, counterweight shaft, counterweight and Vixen-type dovetail saddle, makes the SkyGuider™ Pro mount suitable for a heavier camera/lens system, even a lightweight telescope.

The SkyGuider™ Pro is certainly a must-have tool for any photographer interested in astrophotography or wide field astrophotography.

The latest addition is a SkyGuider Pro with iOptron iPolar™ electronic polar scope (#3550A). It makes the polar alignment quick and easy!



Figure 2. SkyGuider™ Pro mount system (*tripod not included*)

Features:

- All metal mechanical structure
- Attaches to a camera tripod with 3/8" or 1/4" threads
- Capable for dual mount application up to 11lbs (5kg) + 7.7lbs (3.5kg), balanced
- Silent tracking for smooth camera motion, perfect for long-term exposures
- Detachable alt-azi base with fine latitude and azimuth adjusters for easy polar alignment
- Includes iOptron AccuAlign™ dark-field illuminated polar scope
- Adjustable polar scope illumination
- iPolar electronic polar scope (#3550A only)
- 4 tracking speed (1X, 1/2X, solar and lunar). 1X celestial tracking for imaging the sky and stars; 1/2X tracking speed for imaging both the starry night and the landscapes at the same time
- Operation in both northern and southern hemisphere
- Quick slew (144X) for camera framing adjustment
- Built-in rechargeable battery for up to 20 hours of operation (20°C)
- Built-in ST-4 autoguiding port
- HBX port for external hand controller
- USB port for power, charging and firmware upgrade
- Built-in shutter triggering port
- Padded carry bag included
- DEC mounting bracket
- Counterweight and CW shaft
- Vixen dovetail saddle for scope mounting
- Optional ball head available separately (#3305A)
- Optional tripod (#3221)
- Optional Go2Nova® 8408 hand controller (#8408)
- Optional DSLR camera shutter trigger cable

2. SkyGuider™ Pro Camera Mount Assembly

2.1. Introduction

You have just purchased a tracking camera mount that is capable of taking your astrophotography to a new level.. When aligned the polar axis of the SkyGuider™ Pro camera mount with the celestial North Pole (CNP), or celestial South Pole (CSP), the mount will provide rotation matching the celestial sphere rotation around the Earth. Since all celestial objects appear to rotate around the CNP, or CSP, the polar axis allows the mount to rotate with the celestial sphere and provide accurate tracking for visual observations and astrophotography.

The AccuAlign™ polar scope, along with the Quick Polar Alignment procedure, or iPolar™ electronic polar scope, will provide an easy and accurate polar alignment for the mount.

The following sections of this manual provide detailed steps required to successfully set up and operate the SkyGuider™ Pro mount.

2.2. Parts List

PARTS INCLUDED:

The SkyGuider™ Pro camera mount shipping box contains:

- SkyGuider™ Pro camera mount
- Alt-azi base (installed)
- AccuAlign™ dark field illuminated polar scope (installed, for #3550); or
- iPolar™ electronic polar scope (#3550A)
- Micro USB charging cable
- Padded carry bag
- DEC mounting bracket w/ camera mounting disk
- 1.35kg counterweight
- CW shaft
- One year limited warranty (90 day on battery)



Figure 3. Parts in a SkyGuider™ Pro package

OTHER ITEMS NEEDED:

The following items are needed for astrophotography or observation but are not included in the package:

- A sturdy tripod with 3/8" or 1/4" threaded post.
- An power source with a USB port for mount charging, such as a smartphone charger, a laptop with a USB port, or car cigarette adapter, or a portable battery pack
- A camera

YOU MAY NEED IT FOR POLAR ALIGNMENT:

- iPhone/iPad app for accurate polar alignment (<https://itunes.apple.com/us/app/ioptron-polar-scope/id564078961?mt=8>)
- or Android phone polar finder app (<https://play.google.com/store/apps/details?id=com.techhead.polarfinder>)
- Optional Go2Nova[®] 8408 hand controller
- Or other application/program to calculate the pole star position. Please refer to FAQ session under Support at <http://www.ioptron.com> for more information.

ONLINE CONTENTS (click under "Support" menu) www.ioptron.com

- This manual
- Quick Start Guide
- Video Instruction
- Accessories
- Tips for set up
- Reviews and feedback from other customers

2.3. Assembly Terms

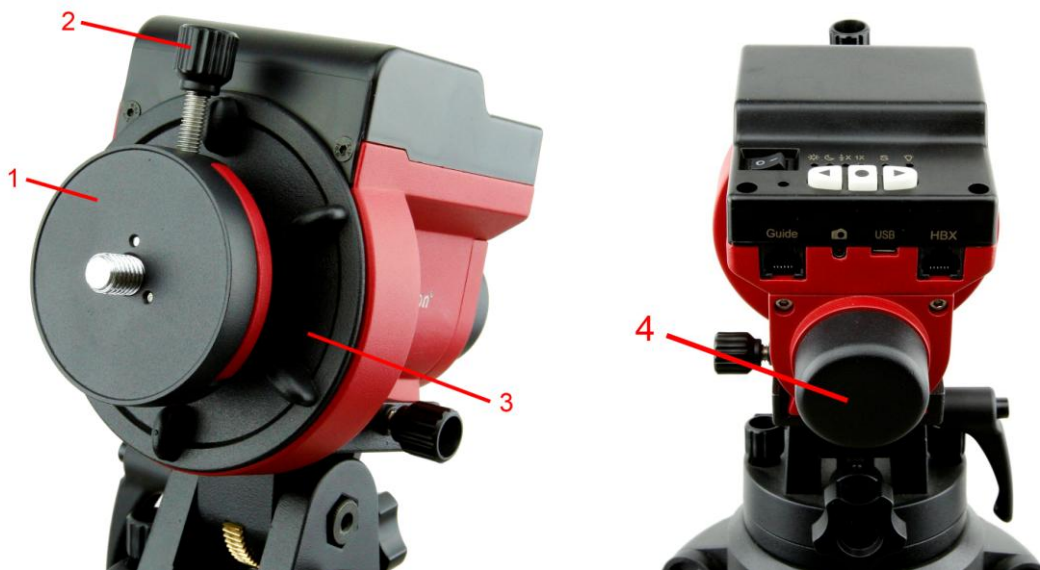

Figure 4. Front and back view of a SkyGuider™ Pro mount head

- 1- Camera mounting block
- 2- Camera mounting block locking screw

- 3- RA clutch disk
- 4- Built-in polar scope



Figure 5. Control panel and ports of a SkyGuider™ Pro mount head

- 5- Power switch
- 6- Battery status indicator
- 7- Function button
- 8- Direction button
- 9- Mount status indicator

- 10- GUIDE port for ST-4 autoguiding
- 11- Camera shutter triggering port
- 12- Micro USB port
- 13- HBX port for optional hand controller



Figure 6. Alt-azi adjusting base

- 14- Dovetail saddle
- 15- Latitude lock
- 16- Azimuth adjusting knob
- 17- Dovetail locking knob
- 18- Azimuth locking knob

- 19- Base
- 20- Latitude adjustment knob
- 21- Latitude scale
- 22- Leveling bubble

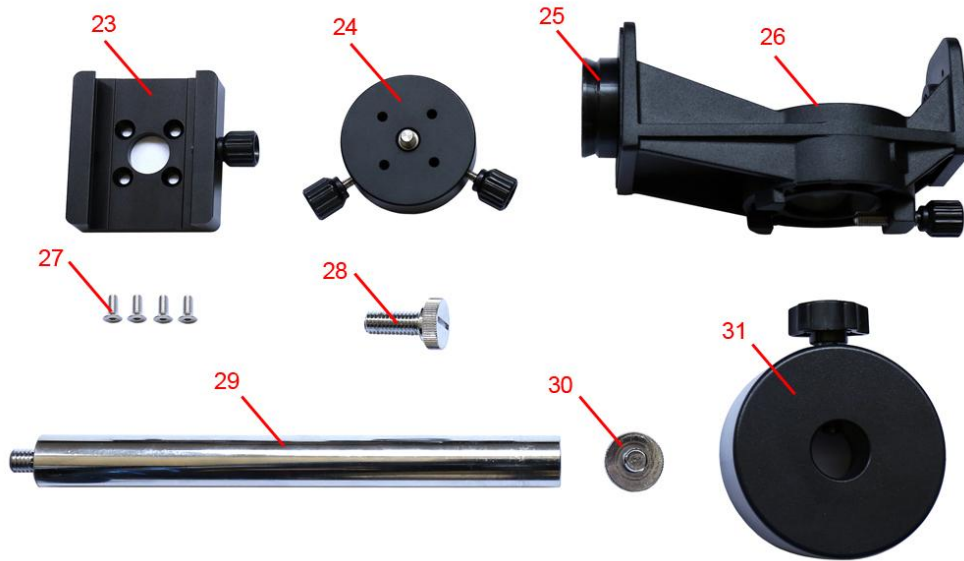

Figure 7. DEC mounting bracket and counterweight package

- | | |
|---|--------------------------------------|
| 23- Vixen-type dovetail saddle | 28- 3/8" Ball head mounting screw |
| 24- DEC camera mounting block | 29- Counterweight shaft |
| 25- DEC base | 30- Counterweight shaft safety screw |
| 26- DEC mounting bracket | 31- Counterweight |
| 27- Screws for dovetail saddle mounting | |

2.4. SkyGuider™ Pro Camera Mount Assembly

NOTE: The SkyGuider™ Pro mount is a precision astronomical instrument. It is highly recommended that you read the entire manual and become familiar with the nomenclature and functions of all components before starting the assembly.

STEP 1. Check/charge the battery

The SkyGuider™ Pro is shipped with battery partially charged. Please fully charge the battery before the first time use. Insert the micro USB plug into the USB port at the back of the mount (see Figure 8), and connect the other end of the USB cable into a USB port of a computer, a smart phone charger or a portable battery pack (not included). The input power should be 5V, >1A. It usually takes 5 hours to charge the internal Li-Poly battery to reach 80% of full power. Turn the power switch on. If the battery indicator LED stays steady on, the battery has the power for mount operation. When the indicator blinks slowly (about 0.5Hz), it indicates the power is low and the battery needs be charged. When the battery is new and fully charged, the status indicator may flash rapidly (about 5Hz). You may charge the SkyGuider™ Pro with the power switch either ON or OFF. However, when the power switch is turned off, the battery status indicator does not function.



Figure 8. MiniUSB powering/charging port

You may use an external battery/power to power the mount through the USB port while using the mount



Please don't charge the battery or use USB power when temperature is at or below 0°C (32°F). It may shorten the battery life.

If the mount is not to be used for an extended period of time, charge the battery in full and recharge every 6 months.

STEP 2. Attach SkyGuider™ Pro mount to a tripod

The SkyGuider™ Pro mount can be mounted to a stable tripod with or without the alt-azi base, as shown in Figure 9. When the alt-azi base is not used, a ball head (#3305A, not included) is suggested for easy adjustment.



Figure 9. Attach SkyGuider™ Pro mount to a tripod

The dovetail base of the SkyGuider™ Pro mount head comes with a 1/4"-3/8" thread converter, as shown in Figure 9. It fits directly to the 3305A ball head quick release plate or any other platform with 1/4" or 3/8" threads screw. The alt-azi base fits to any standard camera or astrophotography tripod with 1/4" or 3/8" threads by insert the 1/4"-3/8" thread converter into it, as needed.



Figure 10. Mount head dovetail base with 1/4"-3/8" thread converter

To use the alt-azi base, just simply slide the mount head base into the alt-azi base dovetail saddle. **You can slide the mount head in from either direction depending on your latitude**

position and payload. The latitude adjustment range can be from -30° to 65° . If possible, choose the one with the center of gravity of the system as close to the center of the base as possible. **The factory default mounting position is on 30° side.**



Figure 11. Alt-azi base latitude settings

STEP 3. Install a ball head and mount a camera

A DSLR camera can be mounted to the SkyGuider™ Pro in many ways. Here are two most common methods.

For a light payload (less than 1.5kg or 3.3lbs, including lens)

A DSLR can be attached directly to the SkyGuider™ Pro mount through a ball head. Loosen the camera mounting block Locking Screw to remove the Camera Mounting Block from the SkyGuider™ Pro. Attach the Mounting Block to the base of a ball head (not included) with a 3/8" threaded mounting hole and turn the mounting block to secure it onto the ball head, as shown in Figure 12. Reattach the mounting block to the SkyGuider™ Pro and tighten the Locking Screw.

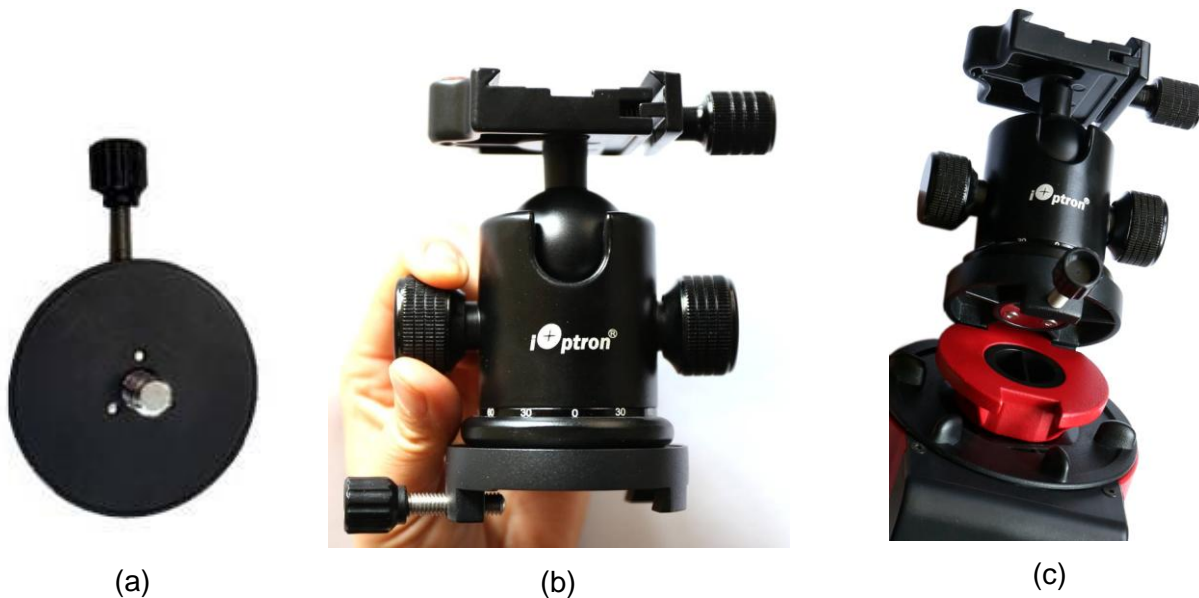

Figure 12. Attach a ball head to the mounting block

Finally, attach the quick release plate of the ball head to the bottom of the DSLR camera and secure it with the 1/4" screw, then attached the camera to the ball head (Figure 13).



Figure 13. Attach a camera

For a heavy DSLR, especially with a long lens (more than 1.5kg or 3.3lbs, including lens)

A DEC Mounting Bracket with a counterweight (CW) and CW shaft (or **Balance Package**) is needed for better balance and performance.

To install the DEC Mounting Bracket, remove the Camera Mounting Block from the mount. Remove the polar scope cap. Install the DEC Bracket and tighten the locking screw to secure it.

Install the CW shaft and load the CW.

Loosen two DEC Camera Mounting Block locking screws to remove it from the DEC Base on the DEC Mounting Bracket. Attach the DEC Camera Mounting Block to the bottom of the DSLR camera and secure it by turning the block. Reattach the DEC Camera Mounting Block to the DEC Base and tighten the two locking screws. The default DEC bracket is CW shaft on the short arm side.



DEC Camera Mounting Block

Figure 14. Mounting a camera with DEC mounting bracket and CW

Release the RA Clutch Disk by tuning it counterclockwise (CCW) while holding the DEC Mounting Bracket. Slowly move the camera/CW to horizontal position and balance the load in RA direction by moving the CW in or out. More than one CW may be used. Return the mount to upward position and lock the RA Clutch Disk again.



Figure 15. Balance the payload

You can also remove the DEC Base from the long arm side of the DEC Mounting Bracket to the short arm side for more balancing torque (Figure 16a, polar scope needs be rotated and adjusted as well), or mount a ball head onto the DEC Camera Mounting Block (Figure 16b), or mount a ball head directly onto the DEC Mounting Bracket via Ballhead Mounting Screw 28 (Figure 16c).

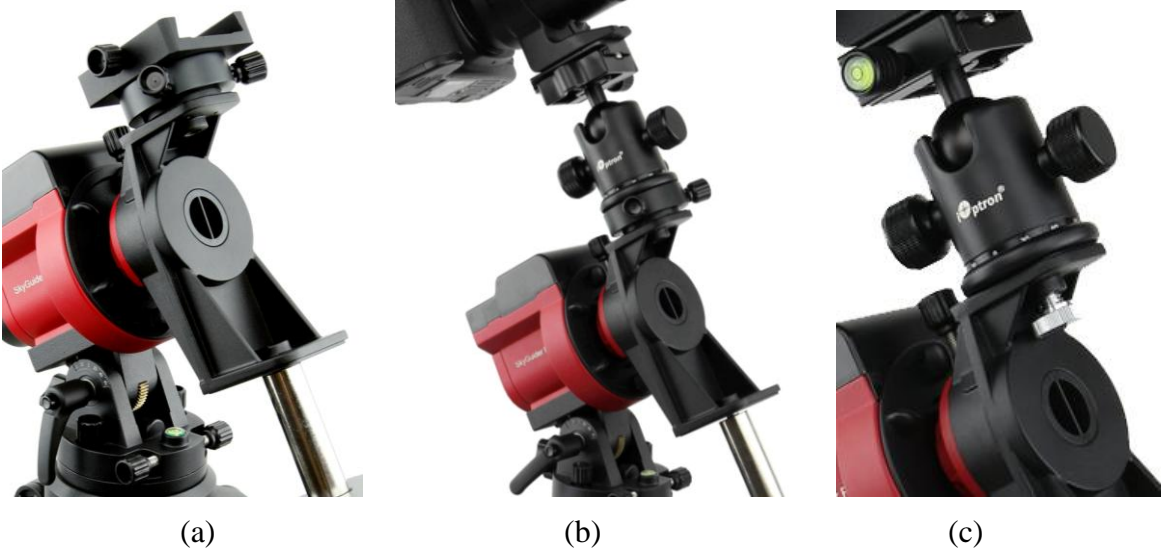

Figure 16. Various mounting methods

STEP 4. Set the SkyGuider™ Pro mount

Assuming you are using the SkyGuider™ Pro mount with the alt-azi base and located in northern hemisphere. Face the mount to the **true** north with assistance of a compass or an electronic compass from your smart phone. *Please note that true north is not necessarily aligned to the magnetic north from you compass.* However, some smart phone compass may display both magnetic north and true north. Rotate the base to align the mount to the north as close as possible. Release the Latitude Lock half a turn by simply rotating the locking lever counterclockwise. Set the latitude scale at your current latitude by turning the Latitude Adjustment Knob and retighten the Latitude Lock. The latitude lock lever can be rotated to any suitable position by pulling and turning.

If your latitude is higher than 30 degree, you can remove the mount head from the AZ base and flip it to the other side, as shown in the following.

Loosen Dovetail locking knob. Remove the SkyGuider Pro mount head from the AZ base. Insert the mount head onto the AZ base from the other end of the dovetail saddle. Lock the Dovetail locking knob again. Adjust the latitude as you needed. You should notice that the Latitude adjusting knob is now in front of the mount head.

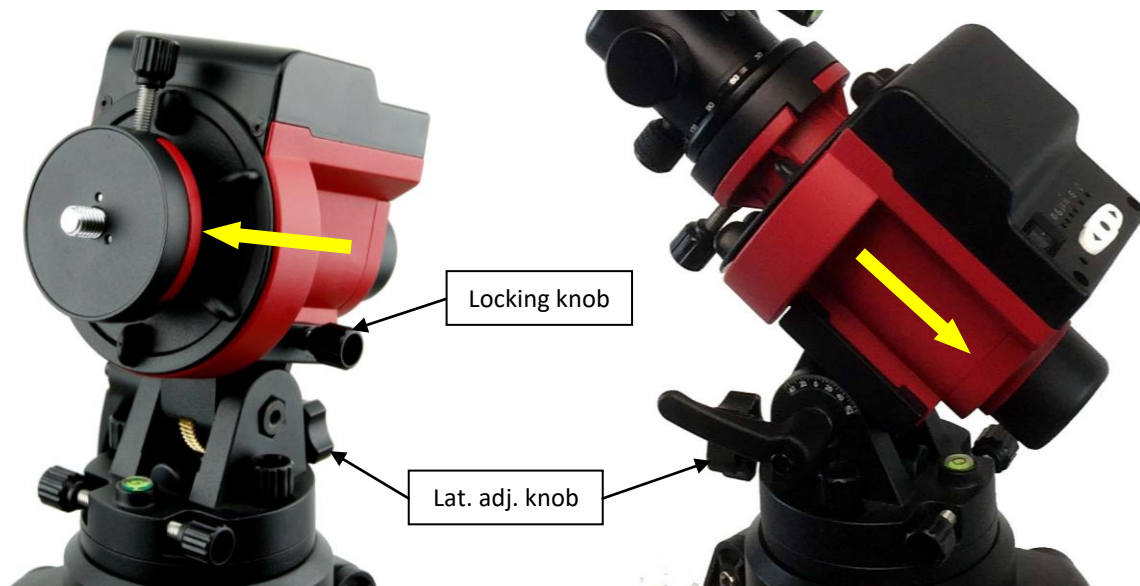

Figure 17. Switch mount head from low latitude to high latitude

Loosen two Azimuth Locking Knobs, adjust the Azimuth Adjusting Knobs to align the polar axis to the north, and then tighten the Azimuth Locking Knobs. More details on polar alignment are in next step.

When powering on, the SkyGuider Pro mount will be in tracking mode at a rate that shown on the Mount Status Indicator. If your goal is only take the wide field image of the sky and stars, set the tracking speed to 1X (celestial tracking speed). With a good polar alignment, this will keep the stars rounded in your image. If you would like to take the image of both the starry sky and the night landscape at the same time, you need to set the tracking speed at 1/2X. This will let you take clear images of both the sky and the land objects at a proper exposure. Solar speed is for tracking the Sun and lunar speed for the moon.

Keep pressing the center round Function Button ● to change the tracking speed from **Solar=>Lunar=>1/2X =>1X.**



Figure 18 Change tracking speed

You may fast slew the RA axis by pressing ◀ or ▶ button while the mount is at tracking mode.

The letter “S” indicates if the mount is set to northern or southern hemisphere. If the LED under “S” is on, it indicates the mount is set to southern hemisphere. To change this setting, press and hold the Function Button ● until the LED under letter “S” starts to blink. Press the ● button to toggle between the “S (LED on)” and “N (LED off)”.



Figure 19 Set southern or northern hemisphere

STEP 5. Polar Alignment

To achieve accurate tracking, precise polar alignment is crucial. SkyGuider™ Pro mount offers a quick polar alignment.

If you are using the mount without DEC Mounting Bracket, you need to remove the Camera Mounting Block to perform the polar alignment. If you are using the mount with DEC Mounting Bracket, you can do polar alignment with the payload.

1. Easy alignment through polar scope

Aiming through the polar scope to the Polaris (or Sigma Octantis) while adjusting the azimuth and altitude angles until putting the Polaris at the cross hairs of the polar scope dial. Lock all the knobs when done. The misalignment to North Pole is about 40 min (or about 1 degree in southern hemisphere with Sigma Octantis).

2. Quick Polar Alignment

You can use iOptron’s AccuAlign™ dark field illuminated polar scope for easy and accurate polar alignment. This is achieved by making the polar axis of the mount parallel to the Earth’s axis of rotation.

As indicated in Figure 20, the Polar Scope Dial has been divided into 12 hours along the angular direction with 10 min ticks, with a large tick every one hour. There are 2 groups, 6 concentric circles marked from 36’ to 44’ and 60’ to 70’, respectively. The 36’ to 44’ concentric circles are for polar alignment in the northern hemisphere using Polaris. While the 60’ to 70’ circles are for polar alignment in the southern hemisphere using Sigma Octantis. If the dial ticks are numbered, the 12 o’clock mark should be on top (Fig. 14a). Otherwise, any one large tick on top can be assigned as 12 o’clock (Fig. 14b).

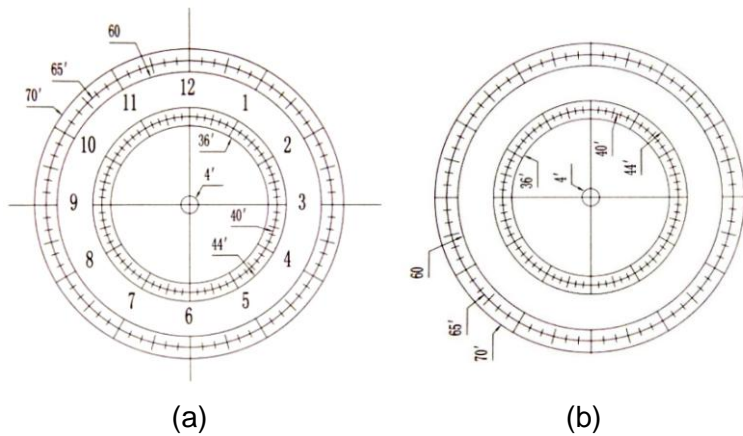

Figure 20. Polar scope dial

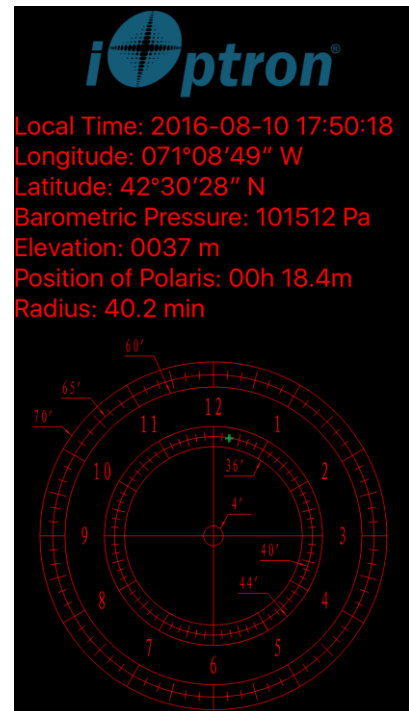

Figure 21. Polar scope app on an iPhone

To maximize the benefits of the iOptron polar scope for polar alignment, you need to know where the Polaris is in the northern hemisphere. (or Sigma Octantis in southern hemisphere.) You may find this information via an iPhone/iPad app (iOptron Polar Scope in Apple iTunes store). Shown in Figure 21 is a screen shot of an iPhone chart. For example, on August 10, 2016, 17:50:18 in Boston, USA (Lat N42°30'28" and Long W71°08'49"), the Polaris Position is 00hr 18.4m and Radius is 40.2min (the green dot on the chart).

Android phone users may refer to a third party Android polar finder app (<https://play.google.com/store/apps/details?id=com.techhead.polarfinder>). You may also use other program/software to calculate the pole star position.

Press the power switch on the mount to turn the SkyGuider™ Pro mount on. Remove metal polar scope cover in the back and polar axis cover in front. **(If you are not using the DEC Mounting Bracket, you have to remove the Camera Mounting Block and ball head to expose the polar scope.)** Look through the polar scope eyepiece. If you can not see red polar scope dial or a large tick mark is not on top, release RA Clutch Disk slightly. Rotate the RA axis until you see the red LED illumination and/or adjust one of the large tick mark to the top. Lock the RA axis. Adjust the eyepiece to bring the reticle dial in focus.



Figure 22. Adjust polar scope position if needed

Adjust the mount in altitude (using Latitude Adjustment Knob) and azimuth (Azimuth Adjusting Knobs) directions to place Polaris in the same position on the Polar Scope Dial as indicated on your iPhone/iPad screen. In this case, the Polaris will be located at a radius of 40.2' and an angle of 00 hour 18.4 minute.

If you feel the polar scope LED is not bright enough, or too bright, you can adjust it. Press and hold the Function Button ● until the LED under letter “S” starts to blink. Release and press and hold ● button again until the LED beneath the “💡” is on. Now you can press ◀ or ▶ to adjust the polar scope illumination intensity.



Figure 23 Polar scope LED intensity adjustment

When done light intensity adjustment, double check the LED under letter “S” to make sure the correct hemisphere is selected.

Now you are ready to track the sky! Point the camera to the sky you are interested in.

3. Polar Alignment with iPolar Electronic Polar Scope

For #3550A, SkyGuider Pro is equipped with an iPolar™ electronic polar scope. To perform polar alignment, please refer to **Appendix B**. It is simple and fast, even the pole star or part of the sky is blocked. Steps are briefly outlined below:

- Download and install iPolar Software (first time use)
- Connect a USB cable between the iPolar port on the mount and a computer USB port
- Calibrate the iPolar Rotation Center (first time use)
- Click Connect and start polar alignment by following on screen instructions

3. Advanced Applications

The SkyGuider™ Pro mount is a versatile mount that can be used in many ways. Here are some advanced applications/functions.

3.1. Autoguide

The SkyGuider™ Pro mount is equipped with a ST-4 compatible guiding port to enable autoguiding while tracking. The default guiding speed is $(1 \pm 0.5X)$. You may change it from $(1 \pm 0.1X)$ to $(1 \pm 0.9X)$ via an optional 8408 hand controller.

The guide port wiring is shown in Figure 24, which is same as that from Celestron / Starlight Xpress / Orion Mount / Orion Autoguider/ QHY5 autoguider pinout.

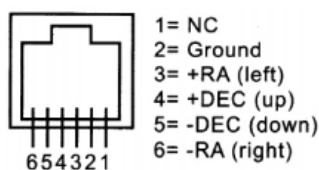

Figure 24. Guide port pinout

If you have an autoguider that has a pinout similar to ST-i of SBIG, such as Meade/ Losmandy/ Takahashi/ Vixen, make sure a proper guiding cable is used with the SkyGuider™ Pro mount. Refer to your guiding camera and guiding software for detailed operation.

3.2. Attach a Telescope

You can also attach a light weight (<11 lbs with all accessories) to a SkyGuider™ Pro mount. The mount comes with a Vixen-type dovetail saddle. Just remove the DEC Camera Mounting Block (item 24 in Figure 7) from the DEC Mounting Bracket. Attach Vixen-type Dovetail Saddle (item 23 in Figure 7) to the DEC Camera Mounting Block using 4 screws. RE attached the DEC Camera Mounting Block back to the DEC Mounting Bracket. Now you and attach a telescope with Vixen-type dovetail bar to the mount, as show in Figure 25.



Figure 25. Attach a telescope

3.3. Dual Camera/Scope Mount

The SkyGuider™ Pro mount is also capable of dual camera/scope mounting as shown below. To maintain a proper balance, you may mount the cameras/scope to DEC mounting bracket with or without extra ball heads, with or without counter weight shaft/CW, with additional accessories.



Figure 26. Dual mounting

3.4. Use Optional 8408 Hand Controller

A Go2Nova® 8408 hand controller, with latest firmware, can be plugged into the HBX port on a SkyGuider™ Pro mount to slew the mount in RA axis, set the mount parameters, display Pole Star position, and control the camera shutter. **You don't need a hand controller to operate the mount.**

3.4.1. Go2Nova® 8408 Hand Controller



Figure 27. Go2Nova® 8408 hand controller

The optional Go2Nova® 8408 hand controller (HC) shown in Figure 27 has a 4 line, 21 character large LCD screen. It has function keys, direction keys and number keys on the front; a HBX port (6-pin) and a serial port (4-pin) at the bottom.

3.4.1.1. Key Description:

- MENU Key: Press “MENU” to enter the Main Menu.
- BACK Key: Move back to the previous screen.
- ENTER Key: Confirm an input, go to the next menu or select a choice.
- Arrow (▲▼◀▶) Keys: The arrow keys are used to control the mount movement. Press and hold ◀(R.A.+), ▶(R.A.-) to move a telescope along the RA direction. (▲ and ▼ buttons do not work for mount movement.) They are also used to browse the menu or move the cursor while in the menu.
- Number Keys: Input numerical values. Also used to adjust R.A. slewing speeds. 1: 1X; 2: 2X; 3: 8X; 4: 16X; 5: 64X; 6: 128X; 7-9: MAX (144X).
- HBX (Handbox) port: connect the HC to a mount using a 6 pin RJ11 cable.
- Serial port: connect the HC to a Computer via a RS232 to 4 pin 4 wire (4P4C) RJ9 cable (iOptron item# 8412) for hand controller firmware upgrade. The pin out of the serial port is shown in Figure 28.

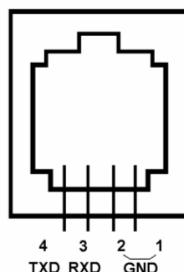

Figure 28. Serial port pin out on an 8408 hand controller

3.4.1.2. The LCD Screen

When the mount is turned on, the HC screen will be displayed as shown in Figure 29, after company logo, HC model and mount type displayed. It displays the mount type, Current GuideRate (0.50), TrackingRate (Sidereal), Mount Status (Track), R.A. Slew Speed (MAX), Current Time (09:20:15) and N/S Hemisphere (N).

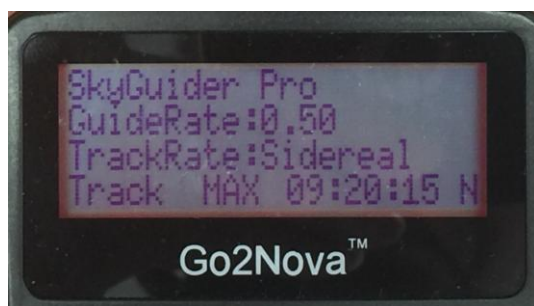

Figure 29. 8408 HC LCD Information Screen

3.4.1.3. Check the Battery



The hand controller has a real time clock (RTC) to keep date and time display correctly after you set the Time Zone and Daylight Saving Time. If the time is incorrect, please check the battery inside the hand controller and replace it if needed. The battery is a 3V button battery.

3.4.2. Go2Nova® 8408 Hand Controller Function

3.4.2.1. Polar Star Position

Press **MENU** button to bring the hand controller submenu, select **Polar Star Position**.

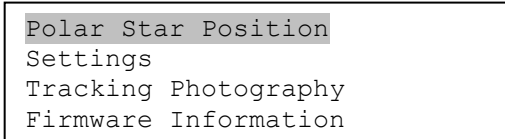

This function displays the position of the Pole Star for Quick Polar Alignment using the iOptron® AccuAlign™ polar scope. In the Northern Hemisphere the position of Polaris is displayed, while in the Southern Hemisphere the position of Sigma Octantis is shown.

For example, on June 22, 2014, 20:19:42 in Boston, US (alt N42°30'32" and long W71°08'50"), UTC -300 minutes, DST:Y, the Polaris Position is 0h45.8m and 40.4m, as shown in Figure 30a.

Look through the polar scope to find the Polaris. Using Azimuth Adjustment Knob and Latitude Adjustment Knob to adjust the mount in altitude and azimuth directions and put the Polaris in the same position on the Polar Scope Dial as indicated on the HC LCD. In this case, the Polaris will be located at a radius of 40.4' and an angle of 0 hour 45.8 minute, as shown in Figure 30b.

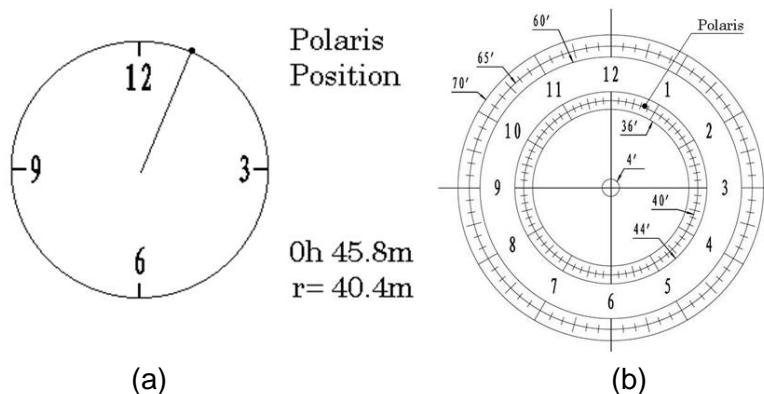

Figure 30. Polaris Position shown on HC (a) and where to put on polar scope dial (b)

NOTE: If you are located in southern hemisphere, Sigma Octantis will be chosen for Polar Alignment. For example, on May 20, 2010, 20:00:00 in Sydney, Australia (Lat S33°51'36" and Long E151°12'40"), 600 min ahead of UT, the Sigma Octantis Position is 1hr21.8m and 64.4m.

3.4.2.2. Settings

This submenu sets the parameters for hand controller as well as the SkyGuider™ Pro mount.

```
Polar Star Position
Settings
Tracking Photography
Firmware Information
```

A. Set Time and Site

The correct time and coordinates are important to display the Pole star position correctly. Press **MENU=>Settings=>Set Time and Site**

```
Set Time and Site
Set Beep
Set Display
Set Tracking Rate
```

Press ENTER. A time and site information screen will be displayed:

```
2013-04-01 12:01:36
UTC -300 Minute(s)
W071d08m50s      DST: N
N42d30m32s      Northern
```

Daylight Saving Time

Set Local Time

Use the ◀ or ▶ key to move the cursor █ and use the number keys to change the numbers. Use the ▲ or ▼ button to toggle between “Y” and “N” for Daylight Saving Time, or “+” and “-” for UTC (Coordinated Universal Time) setting. Hold the arrow key to fast forward or rewind the cursor.

In order to make the Hand Controller reflect your correct local time, **time zone information has to be entered**. Press the ◀ or ▶ key, move the cursor to the third line “UTC -300 Minute(s)” to set the time zone information (add or subtract 60 minutes per time zone). For example:

- Boston is “UTC -300 minutes”
- Los Angeles is “UTC -480 minutes”
- Rome is “UTC +60 minutes”
- Beijing is “UTC +480 minutes”
- Sydney is “UTC +600 minutes”

All the time zones in North America are “UTC -”, as shown in the following table, so ensure the display shows “UTC -” instead of “UTC +” if in North or South America.

Time Zone	Hawaii	Alaska	Pacific	Mountain	Central	Eastern
Hour behind UT	-10	-9	-8	-7	-6	-5
Enter UTC	-600	-540	-480	-420	-360	-300

To adjust minutes, move the cursor to each digit and use the number keys to input the number directly. Use ▲ or ▼ key to toggle between “+” and “-”. When the time information entered is correct, press ENTER and go back to the previous screen.

Do not manually add or subtract an hour from displayed time to reflect Daylight Saving Time (DST). Only select “Y” after DST begins.

For other parts of the world you can find your “time zone” information from internet.

Set Observation Site Coordinate

The third and fourth lines display the longitude and latitude coordinates, respectively. "W/E" means western/eastern hemisphere; "N/S" means northern/southern hemisphere; "d" means degree; "m" means minute; and "s" means second.

Press ◀ or ▶ key to move the cursor and using ▲ or ▼ key to toggle between "W" and "E", "N" and "S", using number key to change the numbers. It is always a good idea to do your home work to get the GPS coordinates before traveling to a new observation site.

The site coordinates information can be found from your smart phone, GPS receiver or via the internet. Site information in decimal format can be converted into d:m:s format by multiplying the decimal numbers by 60. For example, N47.53 can be changed to N47°31'48": $47.53^\circ = 47^\circ + 0.53^\circ$, $0.53^\circ = 0.53 \times 60' = 31.8'$, $0.8' = 0.8 \times 60'' = 48''$. Therefore, $47.53^\circ = 47^\circ 31' 48''$ or 47d31m48s.

Set Daylight Saving Time

Keep moving the cursor by pressing ▶ key after setting the coordinate until it moves on DST section. Change the DST to "N" or "Y" accordingly.

Select N/S Hemisphere

If the polar axis is aligned to the North Celestial Pole, then set the mount to Northern Hemisphere. If the polar axis is pointing to the South Celestial Pole, set the mount to Southern Hemisphere. Press the ◀ or ▶ key to move the cursor and use the ▲ or ▼ key to toggle between "Northern Hemisphere" and "Southern Hemisphere".

As an example, select Northern Hemisphere if you are located in US and press **ENTER** to go back to the main menu.

The time and site information will be stored inside the hand controller's memory chip. If you are not traveling to another observation site, they do not need to be changed.

B. Set Beep

The Hand Controller allows a user to turn off the beep partially, or even go to a silent mode. To change this setting press **MENU** => "**Settings**" => "**Set Beep**",

```
Set Up Time and Site
Set Beep
Set Display
Set Tracking Rate
```

Select one of three available modes:

"**Always On**" – a beep will be heard on each button operation or mount movement;

"**On but Keyboard**" – a beep will be heard only when the mount is slewing to the object or there is a warning message;

"**Always Off**" – all sounds will be turned off, including the SUN warning message.

C. Set Display

Use the arrow keys to adjust LCD display contrast (**LCD contrast**), LCD backlight intensity (**LCD light**), and keypad's backlight intensity (**Key light**).

D. Set Tracking Rate

Press **MENU** => "**Settings**" => "**Set Tracking Rate,**"

```
Set Display
Set Tracking Rate
Set Eyepiece Light
Language
```

Then you can select "**Solar Rate**", "**Lunar Rate**", "**0.5 Sidereal Rate**" or "**Sidereal Rate**". The Mount Status Indicator will reflect the setting changes.

```
Solar Rate
Lunar Rate
0.5X Sidereal Rate
Sidereal Rate
```

E. Set Eyepiece Light

Use this function to adjust the light intensity of SkyGuider Pro illuminated polar scope. If you have an illuminated-reticule eyepiece and has the same socket, you may use this option to adjust its light intensity.

F. Language

Select one of supported menu languages.

```
English
简体中文
```

G. Set Guiding Rate

The default guiding rate of the mount is $0.50 * \text{Sidereal Rate}$, or $(1 \pm 0.5)X$. This setting allows you to change the guiding rate from 0.10 to 0.90 sidereal rate. The guiding rate will be reset to 0.5X when power off the mount.

H. Start Delay Trig

This function only works when a camera is connected to the mount with electric shutter trigger cable and **Tracking Photography** is chosen for imaging session.

Press **MENU** => "**Settings**" => "**Start Delay Trig,**"

```
Set Guiding Rate
Start Delay Trig
Set Time and Site
Set Beep
```

This setting will let you choose how long the camera will wait before taking the first photo after the **Tracking Photography** parameter was set. It can start right away or delay 5, 10 or 20 seconds.

3.4.2.3. Tracking Photography

When a supported camera is connected to the mount via a electric shutter trigger cable, the camera can be controlled by the hand controller. You can set the camera **Shutter Length**, time between each shot (**Interval**) and total **Number of Shots**. You may use these images to make time lapse video later.

Press **MENU** => "**Tracking Photography**" => **ENTER**

```
Polar Star Position
Settings
Tracking Photography
Firmware Information
```

It will bring up the shutter setting menu. Start from "**Input shutter length**" field, Use ◀ or ▶ key to move the cursor and number key to change the number. Keep pressing the ▶ to move the cursor to next session: "**Input interval**", then to "**Input the number of shots**." When finishing settings, move the cursor to ▶ and press the ENTER to start take photo. If you set the delay trig, the hand controller will beep before starting take photos.

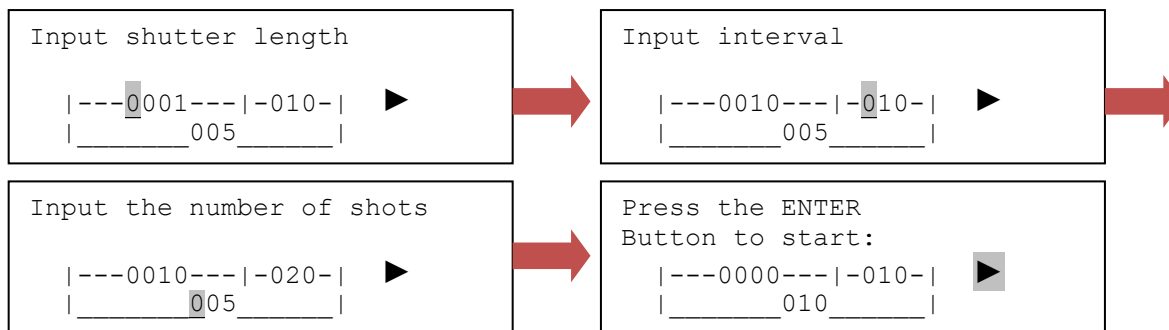

You may press the ENTER button again to stop the imaging process.

You have to turn off the auto focus of the camera and set camera accordingly.

3.4.2.4. Firmware Information

This function displays the firmware version of the hand controller and the SkyGuider™ Pro mount main board.

4. Maintenance and Servicing

4.1. Maintenance

Do not overload the mount. Do not drop the mount. This will damage the mount or degrade the tracking accuracy permanently. Use a damp cloth to clean the mount if necessary. Do not use solvent.

4.2. Trouble Shooting

1. Unit does not power on?

Make sure battery is fully charged.

2. The battery status indicator is flashing quickly even the mount is unplugged from the charger.

This is normal. The battery is fully charged and maintaining the power.

3. Polar scope dial is not illuminated or is not bright enough?

Make sure that the polar scope is rotated to the proper position so LED will illuminate the dial. Follow the instruction to adjust the LED brightness.

4. Polar scope illumination is too bright.

Follow the instruction to adjust the polar scope LED brightness.

5. The polar scope dial is not focused?

Please adjust the polar scope eyepiece to focus your eye sight on to the polar scope dial.

6. Can't see star clearly through the polar scope while doing polar alignment?

The polar scope is calibrated in factory for average eyesight. You need to remove the polar scope from the mount and adjust objective lens. Contact iOptron for an instruction.

7. The star is trailing while imaging?

Polar alignment is critical to the tracking accuracy. Make sure your polar alignment is correct. The tracking speed is set at 1X for sky imaging. Correct Northern/Southern hemisphere is selected.

8. Where should I put the Polaris when doing polar alignment?

You may have one of following choices:

- iPhone App for iOptron polar scope available here:
<https://itunes.apple.com/us/app/ioptron-polar-scope/id564078961?mt=8>
- Android app for iOptron polar alignment here:
<https://play.google.com/store/apps/details?id=com.techhead.polarfinder>
- Or you can download and install a window based program:
<http://www.polarfinder.com/windows.html>
- Or a Mac/windows based program:
<http://www.trutek-uk.com/takahashi/polarisfinder1-2en.htm>. When mapping the Polaris position from the 24 hrs dial to iOptron polar scope, you need to divide it by 2, *i.e.* the reading on the dial is 10 o'clock, then you should put the Polaris in your polar scope at 5 o'clock.
- Or download and print the following table/chart to bring with you to the field if you don't what to carry any electronics, as stated:
<http://www.covingtoninnovations.com/michael/blog/1302/index.html>
- The last approach is just putting the Polaris at the center. It may be good enough for a short exposure depends on the lens you are using.

9. My mount still does not work properly after tried the above solution?

Contact iOptron at support@ioptron.com for technical support.

4.3. iOptron Customer Service

If you have any questions concerning your mount, contact iOptron Customer Service Department. Customer Service hours are 9:00 AM to 5:00 PM, Eastern Time, Monday through Friday. In the unlikely event that the mount requires factory servicing or repairing, write or call iOptron Customer Service Department first to receive a RMA# before returning the mount to the factory. Please provide details as to the nature of the problem as well as your name, address, e-mail address, purchase info and daytime telephone number. We have found that most problems can be resolved by e-mails or telephone calls. So please contact iOptron first to avoid returning the mount for repair.

It is recommended to send technical questions to support@ioptron.com or call in the U.S. 1.781.569.0200.

4.4. Product End of Life Disposal Instructions



This electronic product is subject to disposal and recycling regulations that vary by country and region. It is your responsibility to recycle your electronic equipment per your local environmental laws and regulations to ensure that it will be recycled in a manner that protects human health and the environment. To find out where you can drop off your waste equipment for recycling, please contact your local waste recycle/disposal service or the product representative.

4.5. Battery Replacement and Disposal Instructions



The internal rechargeable battery should be long life if used properly. Nevertheless if a battery needs to be replaced within 90 days from purchase, contact iOptron for free replacement. Otherwise new battery is available at www.ioptron.com.

Battery Disposal- Batteries contain chemicals that, if released, may affect the environment and human health. Batteries should be collected separately for recycling, and recycled at a local hazardous material disposal location adhering to your country and local government regulations. To find out where you can drop off your waste battery for recycling, please contact your local waste disposal service or the product representative.

Appendix A. Technical Specifications (#3550 and #3550A only)

Mount	Compact single axis tracking EQ
Payload (MAX)	11 lbs (5kg)
Mount weight	2.2 lbs (1kg) with battery
Mount weight with base	3.2 lbs (1.450kg) with battery
Body material	Die-cast aluminum
RA shaft	Φ35mm, steel
Worm wheel	Φ88mm, 144 teeth aluminum alloy
Worm gear	Φ15.2mm, brass
Worm period	600 sec
Bearing	4 pieces
Motor drive	DC servo with optical encoder
Tracking	R.A. automatic
Tracking speed	Solar, Lunar. 1X Cel, 1/2 Cel, and N/S
Fast slew speed	144X, forward and reverse
Guiding port	ST-4 compatible
Polar scope	AutoAlign™ dark field illuminated (~6° FOV) (#3550) iPolar electronic polar scope (#3550A)
Camera trigger	Yes
Hand controller	Yes (with optional 8408 HC)
Power requirement	Internal rechargeable battery
Battery type	Li-Poly, 3.7V, 2000mAh
Duration of operation	Up to 20 hours at 20°C
Power charge port	MiniUSB (5V) or MicroUSB
Camera mounting block	Φ62mm, 3/8" post thread
Body-base connection	Vixen dovetail, 3/8" socket (1/4" converter)
Alt-Azi adjustable Base	Vixen style saddle, 3/8" socket
Alt-Azi adjustable base diameter	Φ80 mm
Latitude adjustment range	-30° ~ 65° (with Alt-azi base)
AZ adjustment range	±5°
Level indicator	Level bubble
Body dimension	133x115x95 mm (w/o alt-azi base)
Counterweight shaft	Φ 20x200 mm w/ 3/8"-16 threads
Counterweight	1.35kg
Firmware upgrade	Yes (via USB port)
Operation Temperature	-10~40°C
Warranty	One year limited (90 day on battery)

Appendix B. Polar Alignment using iPolar Electronic PolarScope

Connect iPolar to a PC and Download iPolar Software

- (1) Connect the iPolar Electronic Polar Scope to your PC USB port;
- (2) The iPolar driver will be automatically installed if it is the first time connecting to the computer;
- (3) You should see "iOptron iPolar" under Camera catalog in computer Device Manager;
- (4) Goto www.ioptron.com to download iPolar software and save on your computer;
- (5) The iPolar software needs Windows 7, 8.1, 10 or later version, 32 bit or 64 bit operation system, with .NET Framework 4.8 or later version.

Please refer to iPolar #3339 product page for latest firmware and Instruction Manual:

iPolar Software: https://www.ioptron.com/v/firmware/3339_iOptron_iPolar.exe

Instruction Manual: https://www.ioptron.com/v/manuals/3339_iPolarOperationManual.pdf

IOPTRON WARRANTY

1. iOptron battery has 90 day limited warranty

2. iOptron mount has One (1) year limited warranty

A. iOptron warrants your telescope, mount, or controller to be free from defects in materials and workmanship for one year. iOptron will repair or replace such product or part which, upon inspection by iOptron, is found to be defective in materials or workmanship. As a condition to the obligation of iOptron to repair or replace such product, the product must be returned to iOptron together with proof-of-purchase satisfactory to iOptron.

B. The Proper Return Merchant Authorization Number must be obtained from iOptron in advance of return. Call iOptron at 1.781.569.0200 to receive the RMA number to be displayed on the outside of your shipping container.

All returns must be accompanied by a written statement stating the name, address, and daytime telephone number of the owner, together with a brief description of any claimed defects. Parts or product for which replacement is made shall become the property of iOptron.

The customer shall be responsible for all costs of transportation and insurance, both to and from the factory of iOptron, and shall be required to prepay such costs.

iOptron shall use reasonable efforts to repair or replace any telescope, mount, or controller covered by this warranty within thirty days of receipt. In the event repair or replacement shall require more than thirty days, iOptron shall notify the customer accordingly. iOptron reserves the right to replace any product which has been discontinued from its product line with a new product of comparable value and function.

This warranty shall be void and of no force or effect in the event a covered product has been modified in design or function, or subjected to abuse, misuse, mishandling or unauthorized repair. Further, product malfunction or deterioration due to normal wear is not covered by this warranty.

IOPTRON DISCLAIMS ANY WARRANTIES, EXPRESS OR IMPLIED, WHETHER OF MERCHANTABILITY OF FITNESS FOR A PARTICULAR USE, EXCEPT AS EXPRESSLY SET FORTH HERE. THE SOLE OBLIGATION OF IOPTRON UNDER THIS LIMITED WARRANTY SHALL BE TO REPAIR OR REPLACE THE COVERED PRODUCT, IN ACCORDANCE WITH THE TERMS SET FORTH HERE. IOPTRON EXPRESSLY DISCLAIMS ANY LOST PROFITS, GENERAL, SPECIAL, INDIRECT OR CONSEQUENTIAL DAMAGES WHICH MAY RESULT FROM BREACH OF ANY WARRANTY, OR ARISING OUT OF THE USE OR INABILITY TO USE ANY IOPTRON PRODUCT. ANY WARRANTIES WHICH ARE IMPLIED AND WHICH CANNOT BE DISCLAIMED SHALL BE LIMITED IN DURATION TO A TERM OF ONE YEAR FROM THE DATE OF ORIGINAL RETAIL PURCHASE.

Some states do not allow the exclusion or limitation of incidental or consequential damages or limitation on how long an implied warranty lasts, so the above limitations and exclusions may not apply to you.

This warranty gives you specific legal rights, and you may also have other rights which vary from state to state.

iOptron reserves the right to modify or discontinue, without prior notice to you, any model or style telescope.

If warranty problems arise, or if you need assistance in using your telescope, mount, or controller contact:

iOptron Corporation
Customer Service Department
6E Gill Street
Woburn, MA 01801
www.ioptron.com
support@ioptron.com
Tel. (781)569-0200
Fax. (781)935-2860
Monday-Friday 9AM-5PM EST

NOTE: This warranty is valid to U.S.A. and Canadian customers who have purchased this product from an authorized iOptron dealer in the U.S.A. or Canada or directly from iOptron. Warranty outside the U.S.A. and Canada is valid only to customers who purchased from an iOptron Distributor or Authorized iOptron Dealer in the specific country. Please contact them for any warranty.