



iOptron Planetary Camera Manual

iCAM464C

Product #3373

Ver. 1.1 2023.5

iOptron reserves the rights to revise this instruction without notice. Actual color/contents/design/function of a product may differ from those described in this instruction manual.

Product Description

iCAM464C camera uses a Sony IMX464 color sensor. The imaging area is 1/1.8", with 2.9um pixel size, 4.2MP resolution (2712*1538) and diagonal of 9mm.

iCAM464C camera has a very high sensitivity. It is an idea camera for planetary imaging. The camera has a very low readout noise. The testing results indicated that the readout noise is as low as 0.75e at a gain of 350 and around 0.71e at a gain of 400. The camera has a unique DPS (Dead Pixel Suppression) technology to eliminate the any abnormal/dead pixel by analyzing camera dark frames. The camera has a unique HCG mode, which will automatically turn on when the camera gain setting is ≥ 80 . The HCG mode can greatly reduce the readout noise and retain the same high dynamic range as it at low gain. Due to its unique QE response, the sensitivity reaches the peak at 800-850nm. An IR850 or CH4 filter can be used with the camera for infrared imaging.

When the camera is connected to the USB3.0 interface and full-resolution preview is used, it can reach 93 fps in RAW8 mode (10bit ADC). During image recording, the actual recording speed is affected by the hard drive writing speed. It is recommended to use a high-quality solid state drive to record data to realize the full benefit of the USB3.0 data speed. The ST-4 guiding port allows one to connect the camera to a mount GUIDE port for ST-4 autoguiding.

Package Contents

- iCAM464C Camera
- USB 3.0 cable
- ST-4 guiding cable

Online Contents

- This Manual
- Native camera driver for Windows
- ASCOM driver

System Requirement

- Windows 7/8/10/11 is supported
- Linux and Mac OS are natively supported. To use the camera with a third-party software, you may need to install a INDI drive, which is available in the INDI Library.

Driver Installation (for Windows)

1. Download iCAM/PlayerOne camera driver. Save in a folder or desktop.
2. **DO NOT** connect the camera to the computer yet. Double click on downloaded driver to enter installation page.

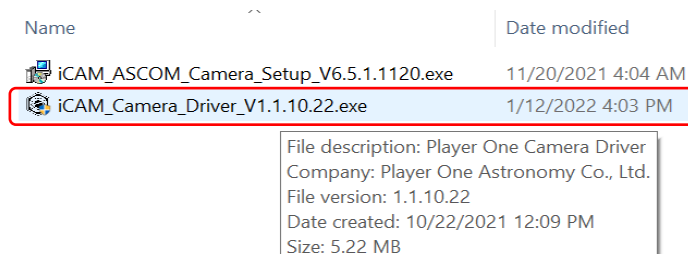

3. Check **License Agreement** and click **Install**.

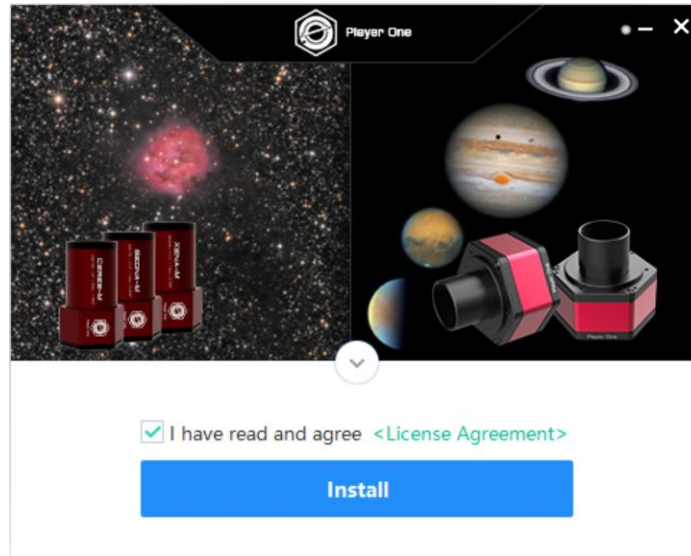

4. Check **Always Trust Software from PlayerOne** and click **Install**.

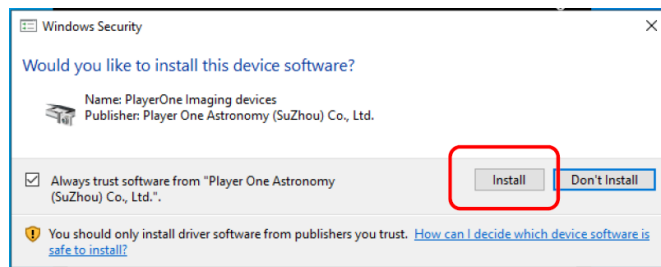

5. Click **Install Finished** when it is down.

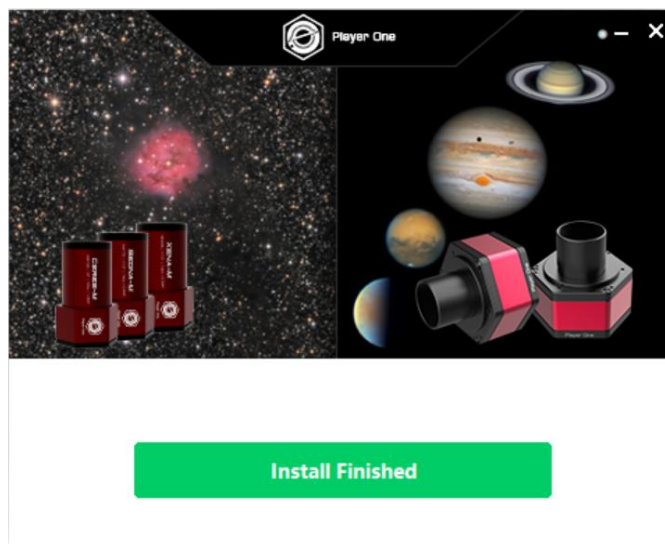

6. Now connect the camera to a computer using included USB 3.0 cable. Check iCAM status in **Device Manager** under **Imaging devices**.

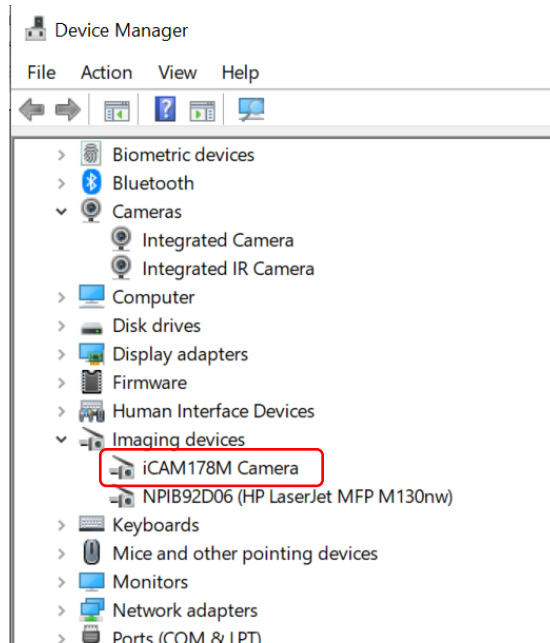

7. Open your Image Capture Software, such as SharpCap. Click on Cameras pull down manual to select the camera, such as iCAM464C.

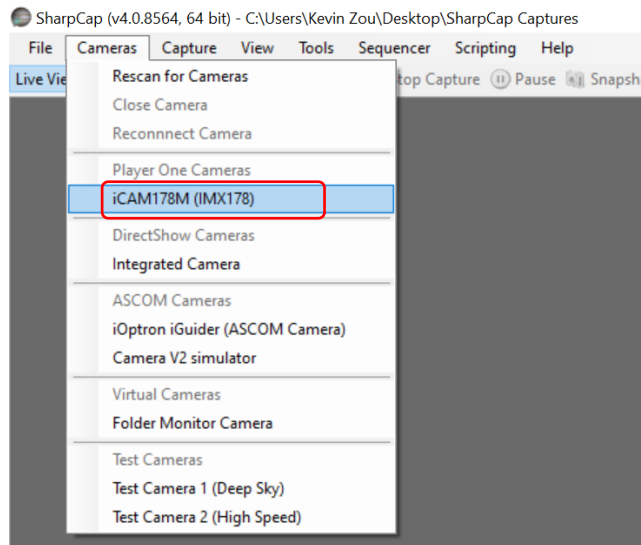

8. Remove camera cover and adjust exposure, you should see the change of brightness. This indicates the camera is working properly.

Camera Characterization

Specifications:

Image Sensor	Sony IMX464 CMOS (color)
Sensor Size	1/1.8" (7.9X4.5mm)
Max. Resolution	2712 X 1538 (4.2MP)
Pixel Size	2.9 μ m
Frame Rate	93 fps (10 bit)
Shutter	Rolling shutter
Exposure Range	32 μ s ~2000s
Readout Noise	2.9e~0.7e
QE Peak	~80%
Full Well	12K e
ADC	12 bit
HCG Mode	Supported
Optical Window	AR coated glass
Data Port	USB3.0/USB2.0
Guide Port	ST-4 compatible
Telescope Adapter	1.25"
Warranty	One year limited

Typical Performances:

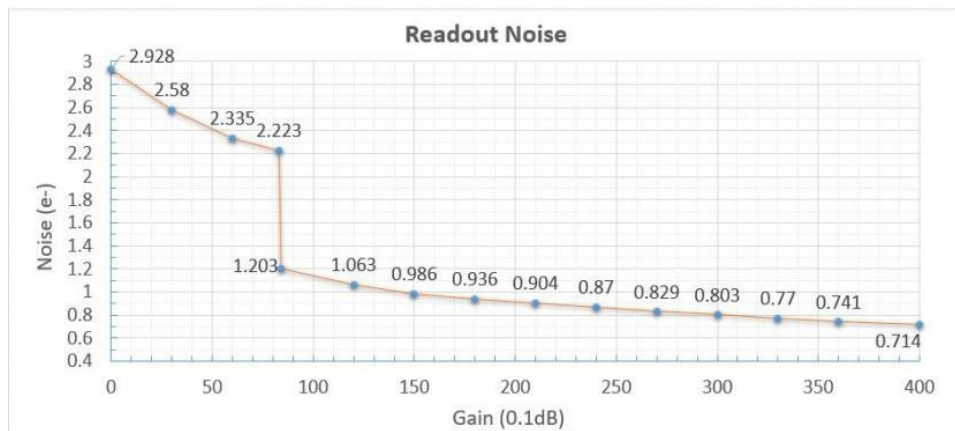
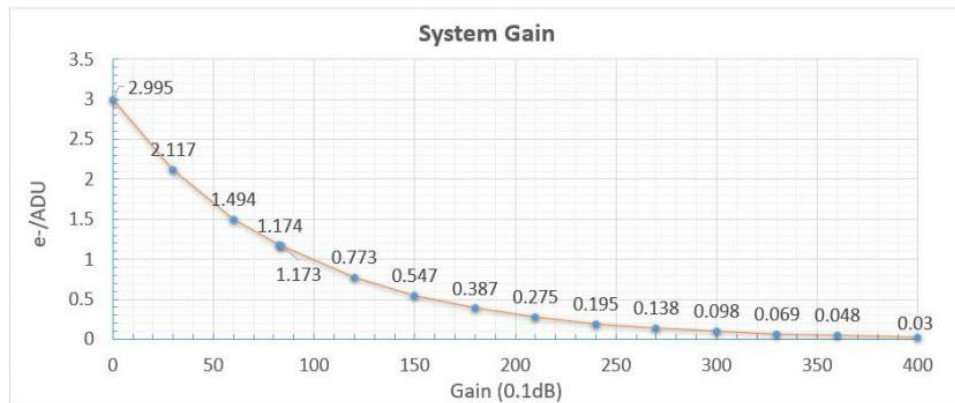

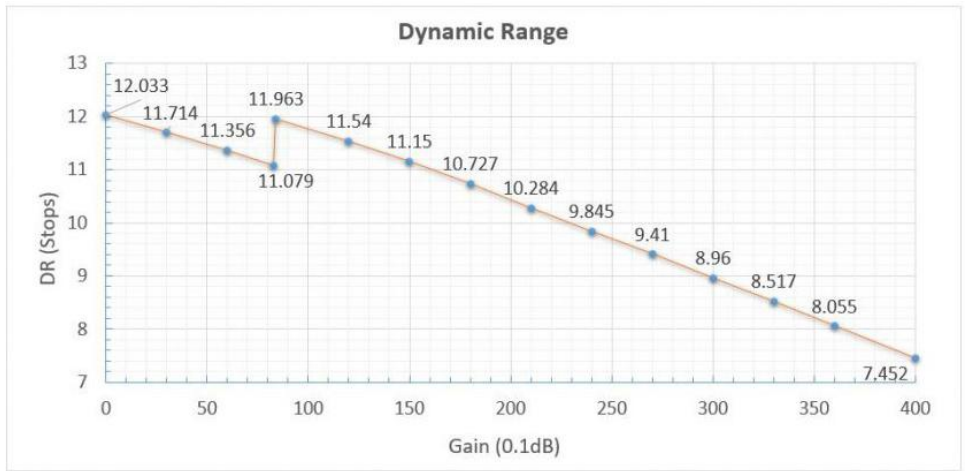
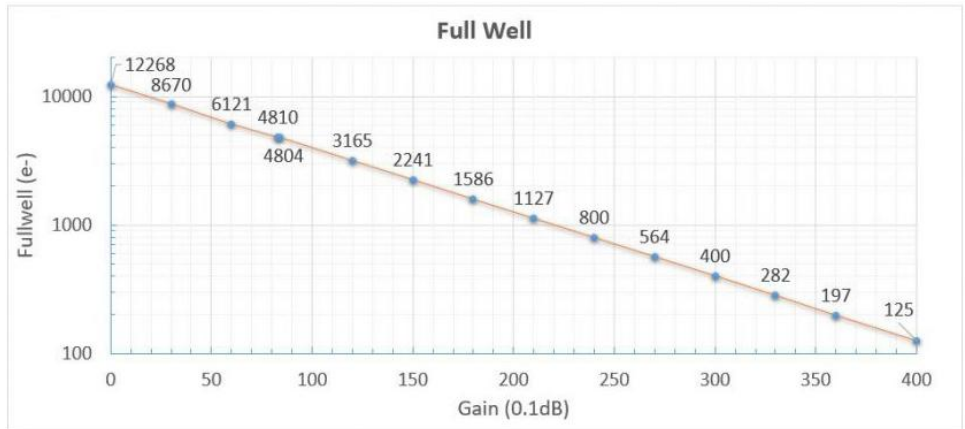

IMX464 QE Curve

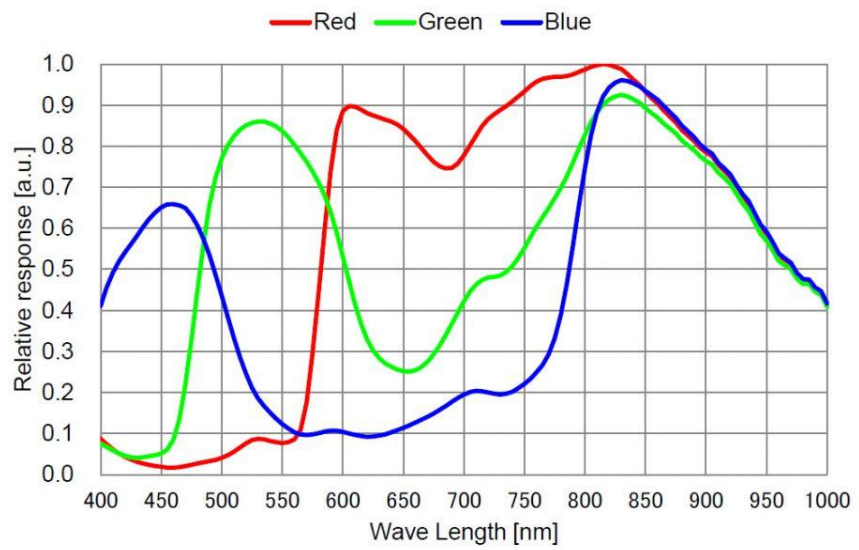

Dimensions:

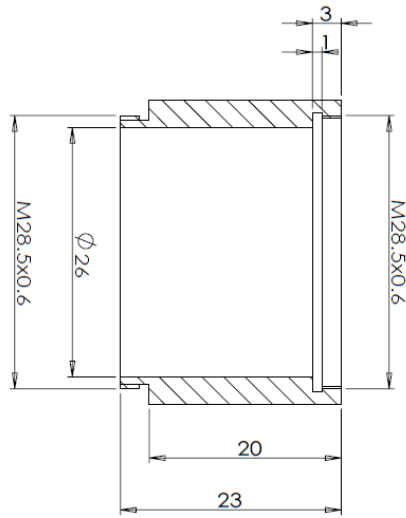
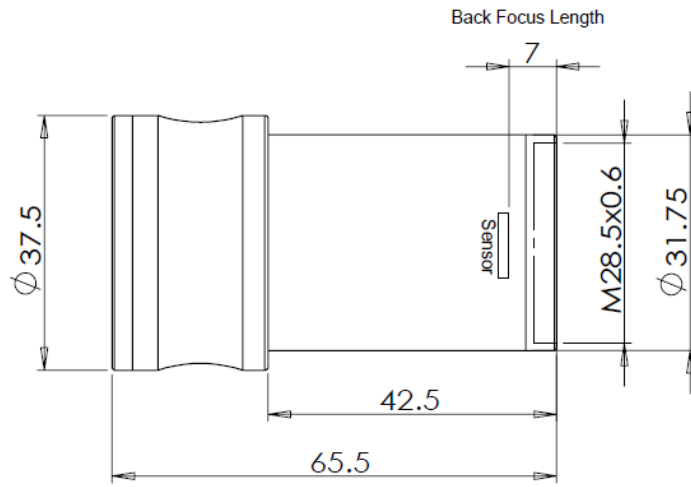

Optional Extension